



LANDA®

illuminotecnica

LUCE ITALIANA

lighting system collection 2012/2013
issue 1

LANDA®



LUCE ITALIANA - MADE IN ITALY

l'azienda

the company
la société
la empresa
die Firma



LANDA®

illuminotecnica

La ditta Landa illuminotecnica ha sede a Lumezzane, Brescia, area dell'Italia del nord conosciuta per il suo spirito imprenditoriale che ha saputo distinguersi in diversi settori. Presente sul mercato dal 1987, si è affermata con la sua ampia gamma di lampade da esterno non solo sul mercato europeo ma a livello mondiale. L'intera produzione avviene all'interno della ditta, consentendo un costante monitoraggio di tutte le fasi produttive fino al momento della spedizione. Vanta inoltre un'equipe di progettazione che non solo riesce a soddisfare le esigenze presentate dalla clientela ma è anche attenta ad anticipare i nuovi bisogni ed i nuovi trend del gusto. Tutto ciò ha permesso una continua crescita in un mercato sempre più competitivo.



www.landa.it

Le siège de la société Landa Illuminotecnica est situé à Lumezzane, près de Brescia, une zone de l'Italie du nord réputée pour son esprit d'entreprise et qui a su se distinguer dans différents secteurs d'activité. Depuis 1987 Landa s'est imposée avec une vaste gamme de luminaires pour extérieur, non seulement sur le marché européen mais également au niveau mondial. Toute la production est réalisée en interne, ce qui permet un contrôle constant de toutes les phases productives jusqu'au moment de l'expédition. Landa dispose d'une équipe de Recherche & Développement capable non seulement de satisfaire les exigences actuelles des clients, mais aussi d'anticiper les nouveaux besoins et l'évolution des goûts et des attentes. Tout ceci a permis une progression constante dans un marché toujours plus concurrentiel.



Landa Illuminotecnica is situated in Lumezzane, Brescia, an area of northern Italy well known for the entrepreneurial spirit of its people, which has made this area very successful in many fields.

Landa was founded in 1987 and has made itself known on the outdoor lighting market, both in Europe and Worldwide, with a comprehensive range of products. All production stages are carried out within the factory bound, so that every step, from production to delivery, can be carefully monitored. Landa's team seeks to fulfil customers' needs as well as trying to anticipate future market needs and trends.

This continuous effort has enabled us to achieve constant growth in an increasingly competitive market.



La empresa Landa Illuminotecnica sita en Lumezzane, Brescia, Italia, conocida por su espíritu emprendedor y supo diferenciarse en varios sectores. Está presente en el mercado desde 1987, se ha consolidado con un extenso surtido de lámparas para exteriores, estamos presentes no solamente en Europa más bien en el mercado a nivel mundial. La totalidad de nuestras piezas están hechas directamente en nuestras instalaciones así controlamos cada paso de la producción desde el comienzo hasta el despacho. Tenemos un grupo de técnicos para proyectar nuestra producción que, no solamente llega a satisfacer las exigencias presentadas por nuestros clientes, también están atentos a anticipar los gustos, las tendencias y las nuevas necesidades del mercado. Todo esto nos ha permitido crecer en un mercado cada vez más competitivo.

Landa Illuminotecnica hat seinen Sitz in Lumezzane Brescia im Norden Italiens, bekannt für seinen Unternehmungsgeist, was die Gegend in so vielen Bereichen erfolgreich macht.

Die Firma Landa wurde 1987 gegründet und hat seitdem eine große Auswahl von Außenleuchten entwickelt, die jetzt auf der ganzen Welt bekannt sind. Jede Stufe der Produktion findet innerhalb der Firma statt, so kann die Ware von der Produktion bis zur Lieferung bestens kontrolliert werden. Unsere Firma beschäftigt ein Planungsteam, das den Ansprüchen der Kunden nachkommt und neue Bedürfnisse und Trends aufgreift. Das hat uns die Möglichkeit gegeben, ein stetiges Wachstum in einem immer wettbewerbsintensiveren Umfeld zu erreichen.



la produzione
the production
la production
la producción
die produktion



newsLED



polos
cod. 403

powered by
Citizen Electronics® LED
10 W - 910LM

pagg. 88

neway
cod. 405

powered by
Citizen Electronics® LED
10 W - 910LM

pagg. 82



dolby
cod. 455

powered by Acriche SEOUL® LED
AC direct connection  230/240V
Transformer not required

pagg. 46



newsLED

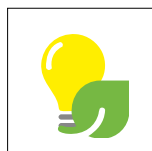

ENERGY SAVING

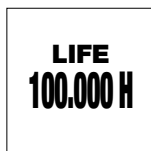

LONG LIFE

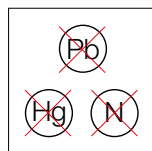

ECOLOGICAL



RECYCLABLE

COLOURS
AVAILABLE

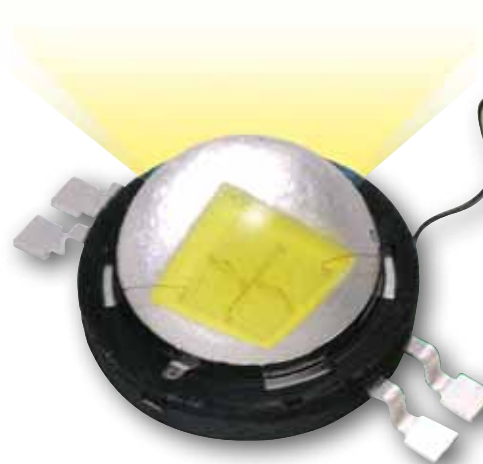
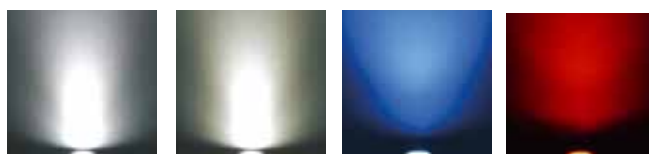

**AC
DIRECT
CONNECTION**

LED

powered by Acriche SEOUL® LED
AC direct connection  230/240V
Transformer not required

prodotti

products
produits
productos
Produktlinien



luce e decoro

*light and decoration
lumière et décoration
luz y adorno
Licht und Dekor*



360 gradi di luce nuova

*360 degrees of modern lighting
360 degrés de nouvelle lumière
360 grados de nueva luz
Rundumlicht 360°*



meticolosa scelta dei materiali

*top quality materials
choix méticuleux des matériaux
meticulosa escogida de los materiales
Materialien bester Qualität*



diverse elettrificazioni

*different electrifications
différentes alimentations
varias modalidades de electrificación
Verschiedene Elektrifizierungen*



personalizzazioni laser

*laser personalization
personnalisation laser
personalizaciones laser
Individualisierung durch Laserschnitt*

I prodotti Landa variano dal tradizionale al moderno e tecnico, tutti realizzati con materiali accuratamente selezionati e sottoposti ai più moderni trattamenti che ne garantiscono la più elevata resistenza agli agenti esterni.

Landa's products range from Traditional to Modern as well as Technical and are all manufactured with carefully selected materials and submitted to the most up to date treatments in order to guarantee the highest resistance to atmospheric agents.

Les produits LANDA varient du style traditionnel au moderne et technique. Tous les articles sont réalisés à partir de matériaux soigneusement sélectionnés et soumis aux traitements les plus modernes pour en assurer la résistance maximum aux agents atmosphériques.

Los productos Landa varían desde lo tradicional a lo moderno y técnico. Todas nuestras piezas están hechas con materiales escogidos con esmero y tratados con los más modernos métodos de trabajo que garantizan la más elevada resistencia.

Landa bietet verschiedene Produktlinien, von traditionell über modern bis technisch. Landa verwendet nur Materialien, die sorgfältig geprüft werden und den modernsten Verarbeitungen entsprechen, um eine hohe Wetterbeständigkeit zu erreichen.

news

sensor product

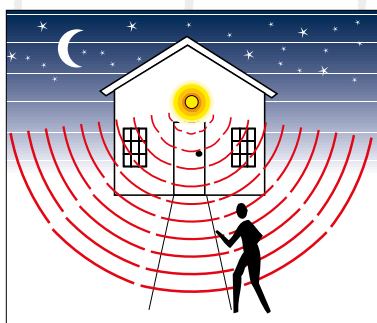

SPECIFICATIONS

Detection range:	160°
Power supply:	230-240 V
Power frequency:	50/60Hz
Reach:	1-8 m (Ø), adjustable
Time setting:	5 sec to 15 min
Light control:	2-2000 LUX
Diffuser:	opal polycarbonate



luna
cod. 440
pagg.92-93



acqua
cod. 9100
pagg.128-129



cervinia
cod. 9008
pagg.122-123



cervinia
cod. 9006
pagg.124-125



maiorca
cod. 421B
pagg.192



rio
cod. 425
pagg.190-191

index

wall lights



traditional stainless steel

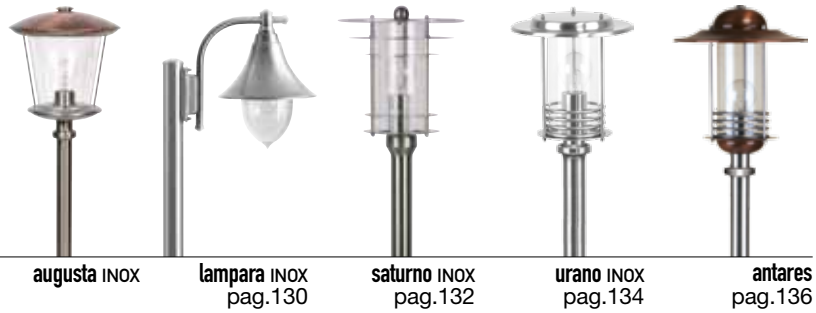

traditional



Colours
pag. 13

Product code index
pag. 319

Technical information
pag. 316

More technical details visit:
www.landa.it

ingrounds & projectors



mira 200
pagg.12÷21

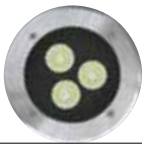

mira 150
pagg.22÷25



NEW
mira 40
pagg.26÷29



NEW
mira 60
pagg.30÷33



NEW
wall mira 40
pagg.34-35



NEW
wall mira 60
pagg.36-37



round brick light



NEW
brick light
pag.38



NEW
brick light
pag.40



flute
pag.42



dolby
pag.44



lyras 80
pagg.46÷49



NEW
lyras 130
pagg.50÷53



NEW
lyras 40
pag.54



NEW
lyras 60
pag.56

sensor



luna
pag.90



cervinia
pag.120



cervinia
pagg.122÷125



acqua
pag.126



rio
pag.186



cipro-maiorca
pag.188

bollards & wall lights



NEW
morphis
pagg.58÷69



NEW
morphis
pagg.58÷69



liberty
pag.70



ivanhoe
pag.72



ibis
pag.74



NEW
oko
pagg.76÷79



neway
pagg.80÷83



polos
pagg.84÷87



polos
pag.88



luna
pag.90



titano
pag.92



titano
pag.94



titano
pag.96



orion
pag.98



orion
pag.100



orion INOX
pag.102



orion INOX
pag.104



urano
pag.106



colonna 52
pag.108



colonna 76
pag.110



colonna 114
pag.112



pali beta
pagg.114-115



pali liberty
pagg.116-117

Country

COLLECTION

Il principio è semplice: verniciare decorando

Film transfer prestampato con pigmenti organici fotosensibili e resine di cellulosa, avvolto interamente sul profilo. Il metodo di decorazione o stampa utilizzato è quello per sublimazione o stampa a caldo. La sublimazione è il passaggio fisico di una materia dallo stato solido a quello aeriforme senza passare dallo stato liquido. Processo produttivo non inquinante: il trasferimento è pulito e secco, senza residui di materiale colorante o residui chimici, acqua di rifiuto: il personale, i boschi, le montagne e i mari ringraziano.

Corpo: alluminio estruso

Test in nebbia salina: > 1500 ore

The principle is simple: coating decorating

Pre-printed film transfer with organic photo sensitive pigments and cellulose resin, completely wrapped around the profile. The decoration or printing method used is the sublimation or heat printing. Sublimation is the physical process: a material changes from a solid condition into a gas condition without ever turning into a liquid condition. Production process is not polluting: the transfer is clean and dry, no colour material waste, no chemical waste, no water waste: personal, woods, mountains and seas are grateful.

Body: aluminium extruded

Test in saline mist: > 1500 hours

El principio es sencillo: pintar decorando

La película plástica ya estampada con pigmentos orgánicos fotosensibles y resinas de celulosa, envuelven completamente el perfil. El método de decoración o impresión utilizado es el de sublimación o impresión a calor. La sublimación es el paso físico de una materia del estado sólido al gaseoso sin pasar por el estado líquido. Proceso productivo no contaminante: él es limpio y seco, sin residuos de material colorante u residuos químicos, agua de residuo: el personal, los bosques, las montañas y los mares agradecen.

Cuerpo: aluminio extrusionado

Test en neblina salinizada: > 1500 horas

Le principe est simple: peindre en décorant

Le film pour transfert pré-imprimé avec pigments organiques photosensibles et résine de cellulose enveloppe entièrement le profil. La méthode de décoration ou d'impression utilisée est celle de la sublimation ou impression à chaud. La sublimation est le passage physique d'une matière de l'état solide à l'état gazeux sans passer par l'état liquide. C'est un procédé de production non polluant: le transfert est précis et sec, sans résidus de matériels colorants, chimiques ou d'eau: le personnel, les bois, les montagnes et les mers remercient.

Corps: aluminium extrudé

Test dans le brouillard salin: > 1500 heures

Das Prinzip ist einfach: lackieren und dekorieren

Es wird zuerst ein Kunststofffilm mit organischen, lichtempfindlichen Pigmenten und Zellharz bedruckt, mit dem das ganze Profil eingehüllt wird. Die Dekorations- oder Druckmethode nennt man Sublimation oder Warmumformen. Sublimation ist der physische Übergang eines Stoffes vom festen Zustand zum gasförmigem Zustand, ohne einen flüssigen Zustand zu haben. Das ist ein umweltfreundlicher Herstellungsprozess, der sauber und trocken ist, ohne Materialrückstand, Chemierückstand und Abwasser. Die Menschen, der Wald, die Berge und die Meere danken uns dafür.

Körper: aluminium

Test Korrosiongeschützt: > 1500 Stunden

colori

colours
couleurs
colores
farben



neway
405.100F18 nhg
pagg. 82÷85



inx
inox - stainless steel
acier - acero - Edelstahl

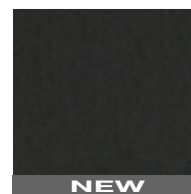

brz
bronzo - bronze - bronce
bronze - Bronze



ngv
nero/verde - black/green
noir/vert - negro/verde
Schwarz/Grün

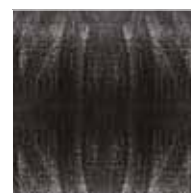

nga
nero/argento - black/silver
noir-argent - negro/plata
Schwarz/Silber



ngo
nero/oro - black/gold
noir/or - negro/oro
Schwarz/Gold



ngr
nero/rame - black/copper
noir/cuivre- negro/cobre
Schwarz/Kupfer



ngg
nero - black - noir
negro - Schwarz



bgg
bianco - white - blanc
blanco - Weiß



all
grigio metallizzato
metal grey - gris métallique
gris metalizado - Metallgrau



nhg
grafite - graphite
graphite - grafite
Graphit

Una vasta gamma di colori opzionali . Componenti cromatizzati garantiti 900 ore in nebbia salina.
A wide range of optional colours is available. Chromatised parts are guaranteed 900 hours in saline mist.

Une vaste gamme de couleurs optionnelles. Composants chromatisés garantis 900 heures dans le brouillard salin.
Extenso surtido de colores a escoger. Piezas cromatizadas y garantizadas con 900 horas en neblina salinizada.

Korrosionsbeständigkeit der chromatisierten Teile 900 Stunden im Salzwasser-Nebel getestet.

LED

powered by
Citizen Electronics® LED
Transformer included

°C
temperatura sul vetro
glass temperature
température de verre
temperatura del vidrio
Glasterperatur

example code:
| art. | electrification | colour |
5011 LL26 ngg

art.

5011
5021
5031
5041

design Ufficio Tecnico Landa

corpo alluminio pressofuso
body in die casting aluminium
corps en aluminium moulé
sous pression
cuerpo aluminio inyectado
Körper aus Aluminium-
Druckguss

diffusore vetro trasparente
diffuser glass transparent
diffuser verre transparent
difusor vidrio transparente
Diffuser Glas klar

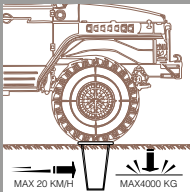

frontale in alluminio / aluminium frame /
cadre en aluminium / comis aluminio /
Rahmen aus Aluminium

5011

COLOURS



ngg



all



5021

frontale in acciaio inox
AISI 316L / stainless steel
AISI 316L frame / cadre
en acier inoxydable AISI
316L / comis acero inox
AISI 316L / Rahmen aus
Edelstahl AISI 316L



5041

frontale in acciaio inox
AISI 316L / stainless steel
AISI 316L frame / cadre
en acier inoxydable AISI
316L / comis acero inox
AISI 316L / Rahmen aus
Edelstahl AISI 316L

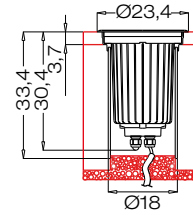

5031

frontale in acciaio inox
AISI 316L / stainless steel
AISI 316L frame / cadre
en acier inoxydable AISI
316L / comis acero inox
AISI 316L / Rahmen aus
Edelstahl AISI 316L



filo pavimento
flush
à niveau du sol
a ras de suelo
Bodeneinbau

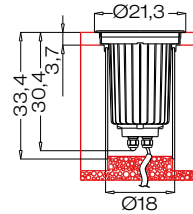

For technical details visit
www.landa.it

IP67



art.	art.	art.	art.		°C	W	V	Type		LUX 1Mt
5011LS26	5021LS26	5031LS26	5041LS26		20°	32	26	240	5000°K 2800LM	11150
5011LS26H	5021LS26H	5031LS26H	5041LS26H		20°	32	26	240	3000°K 2000LM	8000
5011LL26	5021LL26	5031LL26	5041LL26		60°	32	26	240	5000°K 2800LM	2320
5011LL26H	5021LL26H	5031LL26H	5041LL26H		60°	32	26	240	3000°K 2000LM	1650

ELECTRIFICATION

LED

dettagli /
details / details
detalles / details:
pages 4-5

Transformer included

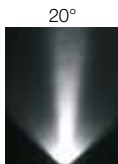

code ...LS26



codeLL26

Also available with:

cod. 0201001.19B
vetro opale/opal glass/
verre opale/vidrio ópalo/Glas opal



cod. 0201001.19A
vetro antiscivolo/non-slip glass/
verre anti dérapant/cristal antiresbaladizo/
rutschhemmendes Glas





LED

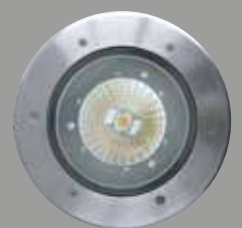

Accessories on request:

Antivandalism set



X 6

00KAV03

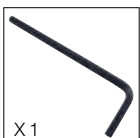

X 1

0303CA3

per/for/pour/
para/für

code: 5011...

Antivandalism set



X 6

00KAV04

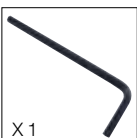

X 1

0303CA3

per/for/pour/
para/für

code: 5021...

code: 5031...

code: 5041...

mira 200

NEW

SYMMETRIC



simmetrico temperatura sul vetro
 symmetric glass temperature
 symétriques température de verre
 simétrico temperatura del vidrio
 symmetrisch Glastemperatur

example code:

art. | electrification | colour |
 5011 | F18 | ngg

art.

5011
 5021
 5031
 5041

design Ufficio Tecnico Landa

corpo alluminio pressofuso
 body in die casting aluminium
 corps en aluminium moulé
 sous pression
 cuerpo aluminio inyectado
 Körper aus Aluminium-
 Druckguss



frontale in alluminio / aluminium frame /
 cadre en aluminium / comis aluminio /
 Rahmen aus Aluminium

5011

COLOURS



ngg



all



frontale in acciaio inox
 AISI 316L / stainless steel
 AISI 316L frame / cadre
 en acier inoxydable AISI
 316L / comis acero inox
 AISI 316L / Rahmen aus
 Edelstahl AISI 316L

5021

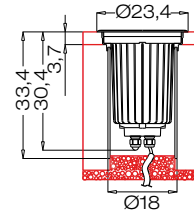

frontale in acciaio inox
 AISI 316L / stainless steel
 AISI 316L frame / cadre
 en acier inoxydable AISI
 316L / comis acero inox
 AISI 316L / Rahmen aus
 Edelstahl AISI 316L

5041

diffusore vetro trasparente
 diffuser glass transparent
 diffuser verre transparent
 difusor vidrio transparente
 Diffuser Glas klar

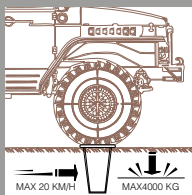

frontale in acciaio inox
 AISI 316L / stainless steel
 AISI 316L frame / cadre
 en acier inoxydable AISI
 316L / comis acero inox
 AISI 316L / Rahmen aus
 Edelstahl AISI 316L

5031



filo pavimento
 flush
 à niveau du sol
 a ras de suelo
 Bodeneinbau

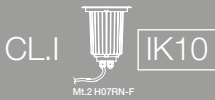
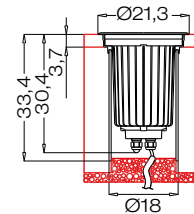

For technical details visit
www.landa.it



art.	art.	art.	art.		°C	W	Type		
5011F18	5021F18	5031F18	5041F18		42	1 x 18	TC-T / GX24 q-2		
5011F26	5021F26	5031F26	5041F26		48	1 x 26	TC-T / GX24 q-3		
5011F42	5021F42	5031F42	5041F42		-60°/+60°	53	1 x 42	TC-T / GX24 q-4	
5011PLE	5021PLE	5031PLE	5041PLE		48	1 x 21		E27	
5011H35	5021H35	5031H35	5041H35		94	1 x 35			
5011H70	5021H70	5031H70	5041H70		-32°/+32°	132	1 x 70		
5011H35S	5021H35S	5031H35S	5041H35S		94	1 x 35		HIT / G12	
5011H70S	5021H70S	5031H70S	5041H70S	-4°/+4°	132	1 x 70			

ELECTRIFICATION

F18	F26	F42	PLE	H35	H70
1 x 18 W Gx24 q-2	1 x 26 W Gx24 q-3	1 x 42 W Gx24 q-4	1 x 21 W E27	H35S 1 x 35 W HIT/G12	H70S 1 x 70 W HIT/G12

Also available with:

cod. 0201001.19B
 vetro opale/opal glass/
 verre opale/vidrio ópalo/Glas opal



cod. 0201001.19A
 vetro antiscivolo/non-slip glass/
 verre anti dérapant/cristal antiresbaladizo/
 rutschhemmendes Glas





SYMMETRIC



Accessories on request:

Antivandalism set



X 6

00KAV03

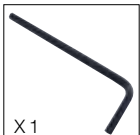

X 1

0303CA3

per/for/pour/
para/für

code: 5011...

Antivandalism set



X 6

00KAV04

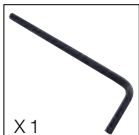

X 1

0303CA3

per/for/pour/
para/für

code: 5021...

code: 5031...

code: 5041...

serie/series

mira 200

NEW

ASYMMETRIC
ADJUSTABLE



asimmetrici regolabili
Adjustable reflectors
asymétriques ajustables
Reflectores ajustables
asymmetrisch und regelbar

°C

temperatura sul vetro
glass temperature
température de verre
temperatura del vidrio
Glastemperatur

example code:

art. | electrification | colour |
5011 | H35AS | ngg |

art.

5011/3
5021/3
5031/3
5041/3

design Ufficio Tecnico Landa

ASYMMETRIC



5011

ADJUSTABLE



5013

frontale in alluminio / aluminium frame /
cadre en aluminium / cornis aluminiu /
Rahmen aus Aluminium

COLOURS

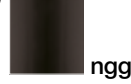

ngg



all



5021



5023

frontale in acciaio inox
AISI 316L / stainless steel
AISI 316L frame / cadre
en acier inoxydable AISI
316L / cornis acero inox
AISI 316L / Rahmen aus
Edelstahl AISI 316L



5041



5043

frontale in acciaio inox
AISI 316L / stainless steel
AISI 316L frame / cadre
en acier inoxydable AISI
316L / cornis acero inox
AISI 316L / Rahmen aus
Edelstahl AISI 316L

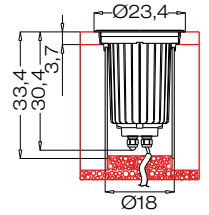

corpo alluminio pressofuso
body in die casting aluminium
corps en aluminium moulé
sous pression
cuerpo aluminio inyectado
Körper aus Aluminium-
Druckguss

diffusore vetro trasparente
diffuser glass transparent
diffuser verre transparent
difusor vidrio transparente
Diffuser Glas klar

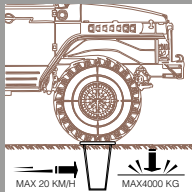

5031



5033

frontale in acciaio inox
AISI 316L / stainless steel
AISI 316L frame / cadre
en acier inoxydable AISI
316L / cornis acero inox
AISI 316L / Rahmen aus
Edelstahl AISI 316L



filo pavimento
flush
à niveau du sol
a ras de suelo
Bodeneinbau



filo pavimento
flush
à niveau du sol
a ras de suelo
Bodeneinbau

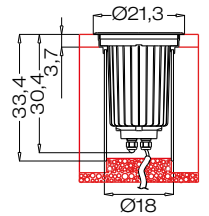

For technical details visit
www.landa.it

IP67

art.	art.	art.	art.	°C	W	Type
5011H35AS	5021H35AS	5031H35AS	5041H35AS	22°	88	1 x 35
5011H70AS	5021H70AS	5031H70AS	5041H70AS		120	1 x 70
5013H35	5023H35	5033H35	5043H35	-32°/+32°	94	1 x 35
5013H70	5023H70	5033H70	5043H70		132	1 x 70
5013H35S	5023H35S	5033H35S	5043H35S	-4°/+4°	94	1 x 35
5013H70S	5023H70S	5033H70S	5043H70S		132	1 x 70

ELECTRIFICATION

H35AS	H70AS	H35	H70
35 W G8,5	70 W G8,5	H35S 1 x 35 W HIT/G12	H70S 1 x 70 W HIT/G12

Also available with:

cod. 0201001.19B
vetro opale/opal glass/
verre opale/vidrio ópalo/Glas opal

cod. 0201001.19A
vetro antiscivolo/non-slip glass/
verre anti dérapant/cristal antiresbaladizo/
rutschhemmendes Glas



ASYMMETRIC

ADJUSTABLE



Accessories on request:

Antivandalism set



X 6

00KAV03

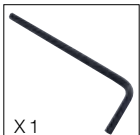

X 1

0303CA3

per/for/pour/
para/für

code: 5011...
code: 5013...

Antivandalism set



X 6

00KAV04

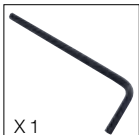

X 1

0303CA3

per/for/pour/
para/für

code: 5021...
code: 5023...
code: 5031...
code: 5033...
code: 5041...
code: 5043...

mira 200

NEW

COOL TOUCH

simmetrico
symmetric
symétriques
simétrico
symmetrisch

asimmetrici regolabili
Adjustable reflectors
Asymétriques ajustables
Reflectores ajustables
asymmetrisch und regelbar

°C
temperatura sul vetro
glass temperature
température de verre
temperatura del vidrio
Glasterperatur

example code:
art. | electrification | colour |
5012 | H35 | all

art.

5012
5022
5032
5042

design Ufficio Tecnico Landa

corpo alluminio pressofuso
body in die casting aluminium
corps en aluminium moulé
sous pression
cuerpo aluminio inyectado
Körper aus Aluminium-
Druckguss



frontale in alluminio / aluminium frame /
cadre en aluminium / cornis aluminio /
Rahmen aus Aluminium

5012



frontale in acciaio inox
AISI 316L / stainless steel
AISI 316L frame / cadre
en acier inoxydable AISI
316L / cornis acero inox
AISI 316L / Rahmen aus
Edelstahl AISI 316L

5022



frontale in acciaio inox
AISI 316L / stainless steel
AISI 316L frame / cadre
en acier inoxydable AISI
316L / cornis acero inox
AISI 316L / Rahmen aus
Edelstahl AISI 316L

5042

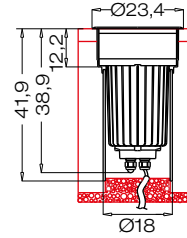

diffusore vetro trasparente
diffuser glass transparent
diffuser verre transparent
difusor vidrio transparente
Diffuser Glas klar

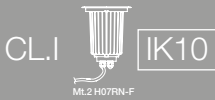
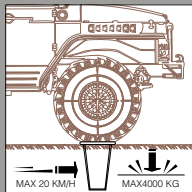

frontale in acciaio inox
AISI 316L / stainless steel
AISI 316L frame / cadre
en acier inoxydable AISI
316L / cornis acero inox
AISI 316L / Rahmen aus
Edelstahl AISI 316L

5032





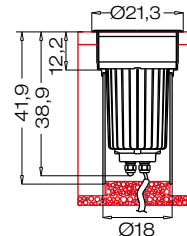

filo pavimento
flush
à niveau du sol
a ras de suelo
Bodeneinbau



For technical details visit
www.landa.it

IP67 

art.	art.	art.	art.		°C	W	Type	
5012H35	5022H35	5032H35	5042H35	-32°/+32°	59	1 x 35	HIT / G12	
5012H70	5022H70	5032H70	5042H70		79	1 x 70		
5012H35S	5022H35S	5032H35S	5042H35S	-4°/+4°	59	1 x 35	HIT / G12	
5012H70S	5022H70S	5032H70S	5042H70S		79	1 x 70		

ELECTRIFICATION

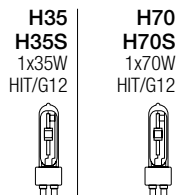

Also available with:

cod. **0201001.19B**
vetro opale/opal glass/
verre opale/vidrio ópalo/Glas opal 

cod. **0201001.19A**
vetro antiscivolo/non-slip glass/
verre anti dérapant/cristal antiresbaladizo/
rutschhemmendes Glas 



Accessories on request:

Optional:



cod. **0201006**
vetro asimmetrico/asymmetric
glass/verre asymétrique/
vidrio asimétrico/
asymmetrisches Glas

15°

Antivandalism set



X 6
00KAV03

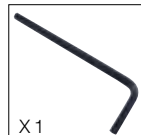

X 1
0303CA3

per/for/pour/
para/für
code: **5012...**

Antivandalism set



X 6
00KAV04

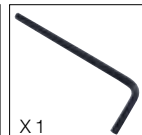

X 1
0303CA3

per/for/pour/
para/für
code: **5022...**
code: **5032...**
code: **5042...**

serie/series

mira 200

NEW

example code:
 | art. | electrification | colour |
 5051 | E27 | ngg

art.

5051
5061

design Ufficio Tecnico Landa



5051

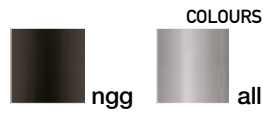
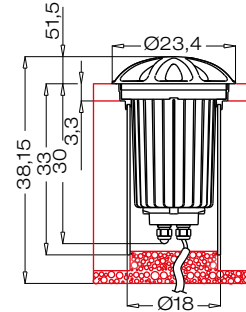

corpo alluminio pressofuso
 body in die casting aluminium
 corps en aluminium moulé
 sous pression
 cuerpo aluminio inyectado
 Körper aus Aluminium-
 Druckguss



5061

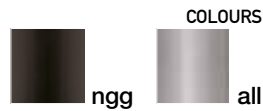
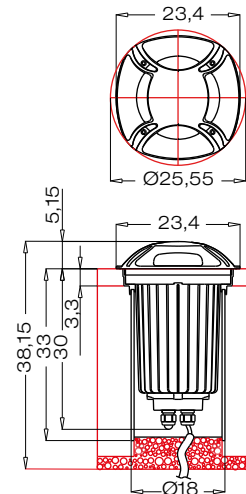

diffusore vetro opale
 diffuser glass opal
 diffuser verre opale
 difusor vidrio ópalo
 Diffuser Glas opal

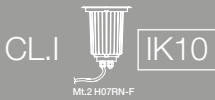
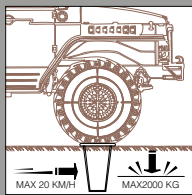

For technical details visit
www.landa.it

IP67

art.	art.	W	Type	Light Bulb Icon
5051E27	5061E27	1 x 23		E27
5051F18	5061F18	1 x 18	TC-T / GX24 q-2	
5051F26	5061F26	1 x 26	TC-T / GX24 q-3	
5051H35	5061H35	1 x 35	HIT / G12	
5051H70	5061H70	1 x 70	HIT / G12	

ELECTRIFICATION

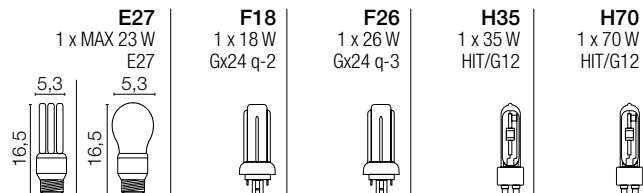





powered by
SEOUL® LED
Transformer included



powered by Acriche
SEOUL® LED
AC direct connection
230/240V
Transformer not required

°C
temperatura sul vetro
glass temperature
température de verre
temperatura del vidrio
Glastemperatur

example code:
art. **LED 10°** colour
5111 LS3 H all

art.

5111
5121
5131
5141

design Ufficio Tecnico Landa

corpo alluminio pressofuso
body in die casting aluminium
corps en aluminium moulé
sous pression
cuerpo aluminio inyectado
Körper aus Aluminium-
Druckguss

diffusore vetro trasparente
diffuser glass transparent
diffuser verre transparent
difusor vidrio transparente
Diffuser Glas klar

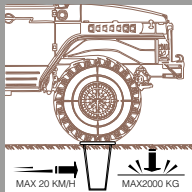

For technical details visit
www.landa.it



5111 (3W)



5111 (12W)

frontale in alluminio / aluminium frame /
cadre en aluminium / cornis aluminium /
Rahmen aus Aluminium

COLOURS

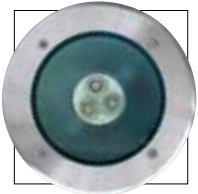

5121 (3W)

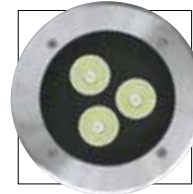

5121 (12W)

frontale in acciaio inox
AISI 316L / stainless steel
AISI 316L frame / cadre
en acier inoxydable AISI
316L / cornis acero inox
AISI 316L / Rahmen aus
Edelstahl AISI 316L

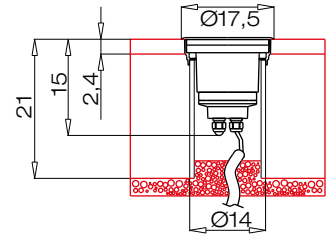

5141 (3W)



5141 (12W)

frontale in acciaio inox
AISI 316L / stainless steel
AISI 316L frame / cadre
en acier inoxydable AISI
316L / cornis acero inox
AISI 316L / Rahmen aus
Edelstahl AISI 316L



5131 (3W)



5131 (12W)

frontale in acciaio inox
AISI 316L / stainless steel
AISI 316L frame / cadre
en acier inoxydable AISI
316L / cornis acero inox
AISI 316L / Rahmen aus
Edelstahl AISI 316L

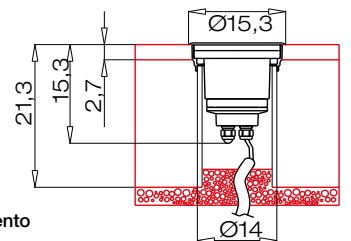

filo pavimento
flush
à niveau du sol
a ras de suelo
Bodeneinbau

art.	art.	art.	art.		°C	W	V	Type		LUX 1Mt
5111LS3	5121LS3	5131LS3	5141LS3					6300°K 300LM		3950
5111LS3H	5121LS3H	5131LS3H	5141LS3H		10°	30	3 240	3200°K 240LM		3120
5111LS3B	5121LS3B	5131LS3B	5141LS3B					66LM		900
								144LM		1900
5111LL3	5121LL3	5131LL3	5141LL3					6300°K 300LM		400
5111LL3H	5121LL3H	5131LL3H	5141LL3H		45°	30	3 240	3200°K 240LM		312
5111LL3B	5121LL3B	5131LL3B	5141LL3B					66LM		90
								144LM		190
5111LS12	5121LS12	5131LS12	5141LS12		12°	40	12 240	6000°K 780LM		4000
								3500°K 660LM		3400
					40°	40	12 240	6000°K 780LM		850
								3500°K 660LM		700

ELECTRIFICATION



dettagli / details / details
detales / details:
pages 4-5

(3W) Transformer included

10°

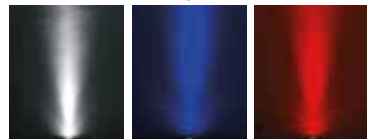

codeLS3 codeLS3B codeLS3R

45°

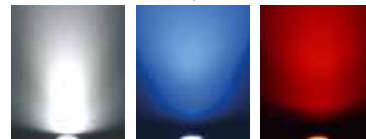

codeLL3 codeLL3B codeLL3R

(12W) Transformer not required

12°



codeLS12 codeLL12

40°



LED

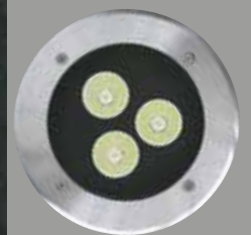

Accessories on request:

Also available with:



cod. **0201007B**
vetro opale/opal glass/
verre opale/vidrio ópalo/
Glas opal

Antivandalism set



X 4

00KAV02

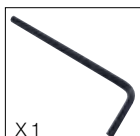

X 1

0303CA3

per/for/pour/
para/für
code: **5111...**

Antivandalism set



X 4

00KAV01

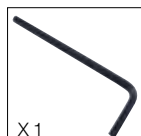

X 1

0303CA2.5

per/for/pour/
para/für
code: **5121...**
code: **5131...**
code: **5141...**

mira 150

NEW



simmetrico
symmetric
symétriques
simétrico
symmetrisch

°C

temperatura sul vetro
glass temperature
température de verre
temperatura del vidrio
Glasterperatur

example code:

art. 5111 | electrification GU5.3 | colour ngg

art.

5111
5121
5131
5141

design Ufficio Tecnico Landa



5111

frontale in alluminio / aluminium frame /
cadre en aluminium / cornis aluminiu /
Rahmen aus Aluminium

COLOURS



ngg



all



5121

frontale in acciaio inox
AISI 316L / stainless steel
AISI 316L frame / cadre
en acier inoxydable AISI
316L / cornis acero inox
AISI 316L / Rahmen aus
Edelstahl AISI 316L



5141

frontale in acciaio inox
AISI 316L / stainless steel
AISI 316L frame / cadre
en acier inoxydable AISI
316L / cornis acero inox
AISI 316L / Rahmen aus
Edelstahl AISI 316L

corpo alluminio pressofuso
body in die casting aluminium
corps en aluminium moulé
sous pression
cuerpo aluminio inyectado
Körper aus Aluminium-
Druckguss



5131

frontale in acciaio inox
AISI 316L / stainless steel
AISI 316L frame / cadre
en acier inoxydable AISI
316L / cornis acero inox
AISI 316L / Rahmen aus
Edelstahl AISI 316L



filo pavimento
flush
à niveau du sol
a ras de suelo
Bodeneinbau

diffusore vetro trasparente
diffuser glass transparent
diffuser verre transparent
difusor vidrio transparente
Diffuser Glas klar

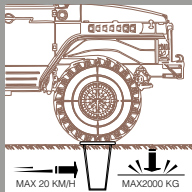

For technical details visit
www.landa.it



Dimension for:
GU5.3
G9
GU10
GX53

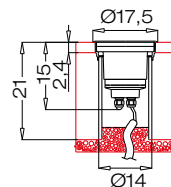

Dimension for:
BT50
B15D
H20
H20S
PLE

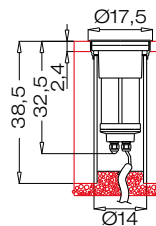

Dimension for:
F26
H35
H70

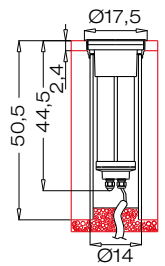

Dimension for:
GU5.3
G9
GU10
GX53

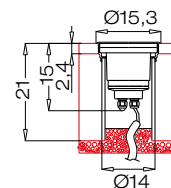

Dimension for:
BT50
B15D
H20
H20S
PLE

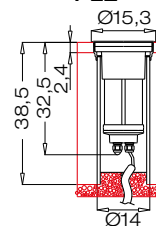

Dimension for:
F26
H35
H70

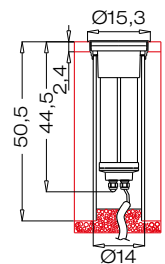

art.	art.	art.	art.		°C	W	V	Type					
5111	GU5.3	5121	GU5.3	5131	GU5.3	5141	GU5.3	140	1 x 50	12	GU5,3		
	5111	G9	5121	G9	5131	G9	5141	G9	-32°/+32°	140	1 x 75	G9	
	5111	GU10	5121	GU10	5131	GU10	5141	GU10	160	1 x 50		PAR 16 / GU10	
	5111	GX53	5121	GX53	5131	GX53	5141	GX53	40	1 x 13		GX53	
	5111	BT50	5121	BT50	5131	BT50	5141	BT50	140	1 x 50	240/12	GU5,3	
	5111	B15D	5121	B15D	5131	B15D	5141	B15D	-32°/+32°	230	1 x 150	B15d	
	5111	H20	5121	H20	5131	H20	5141	H20	70	1 x 20		HIT / PGJ5	
	5111	H20S	5121	H20S	5131	H20S	5141	H20S	-5°/+5°	70	1 x 20	HIT / PGJ5	
	5111	PLE	5121	PLE	5131	PLE	5141	PLE	-60°/+60°	50	1 x 21	E27	
	5111	F26	5121	F26	5131	F26	5141	F26	-60°/+60°	55	1 x 26	Gx24 q-3	
	5111	H35	5121	H35	5131	H35	5141	H35	-32°/+32°	85	1 x 35		
	5111	H70	5121	H70	5131	H70	5141	H70		115	1 x 70	HIT / G12	
	5111	H35S	5121	H35S	5131	H35S	5141	H35S		85	1 x 35		
	5111	H70S	5121	H70S	5131	H70S	5141	H70S	-4°/+4°	115	1 x 70		

art. 51...GU5.3 no transformer / art. 51...BT50 with transformer

ELECTRIFICATION

GU5.3
BT50
1 x 50 W
GU5,3



G9
1 x 75 W
G9



GU10
1 x 50 W
PAR 16/GU10



GX53
1 x 13 W
GX53

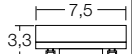

B15D
1 x 150 W
B15d



H20
H20S
1 x 20 W
HIT/PGJ5

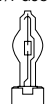

PLE
1 x 21 W
E27



F26
1 x 26 W
Gx24 q-3



H35
H35S
1 x 35 W
HIT/G12

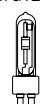

H70
H70S
1 x 70 W
HIT/G12

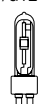



Accessories on request:

Also available with:



cod. **0201007B**
vetro opale/opal glass/
verre opale/vidrio ópalo/
Glas opal

Antivandalism set



X 4

00KAV02

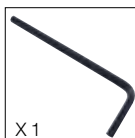

X 1

0303CA3

per/for/pour/
para/für
code: 5111...

Antivandalism set



X 4

00KAV01

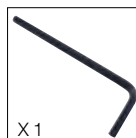

X 1

0303CA2.5

per/for/pour/
para/für
code: 5121...
code: 5131...
code: 5141...

LED
powered by
SEOUL® LED

simmetrico
symmetric
symétriques
simétrico
symmetrisch

example code:
art. LED 10°  anodized
5401 LS3 H inx

art.

5401

design Ufficio Tecnico Landa



5401LS



10°

code ...LS1
...LS3

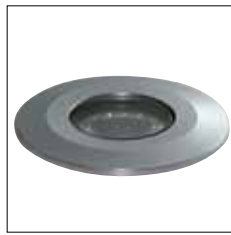

5401LL



40°

code ...LL1
...LL3

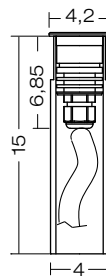





5401L



code ...L1
...L3

corpo alluminio estruso
anodizzato
body in extruded anodized
aluminium
corps en aluminium extrudé
anodisé
cuerpo en aluminio extrusionado
y anodizado
Körper aus eloxiertem
fließgepresst Aluminium

diffusore vetro trasparente
e opale
diffuser glass transparent
and opal
diffuser verre transparent
et opale
difusor vidrio transparente
y ópalo
Diffuser Glas klar un opal

art.	LUX 1mt		art.	LUX 1mt		art.	LUX 1mt		W	mA	Type	
5401LS1	950	10°	5401LL1	175	40°	5401L1	20		1	350	6000°K	110LM
5401LS1H	770		5401LL1H	145		5401L1H	15				3000°K	90LM

Accessories on request:

electronic Transformer from **1 to 2 LED** cod. 0409BT012 – 20V 350mA IP67

electronic Transformer from **3 to 12 LED** cod. 0409BT009 – 48V 350mA IP67

5401LS3	1640	10°	5401LL3	310	40°	5401L3	34		3	700	6000°K	190LM
5401LS3H	1310		5401LL3H	245		5401L3H	26				3000°K	150LM

Accessories on request:

electronic Transformer from **1 to 2 LED** cod. 0409BT011 – 11V 700mA IP67

electronic Transformer from **3 to 12 LED** cod. 0409BT010 – 48V 700mA IP67



For technical details visit
www.landa.it



ELECTRIFICATION

LED

dettagli / details / details
detalles / details:
pages 4-5

Installation example:

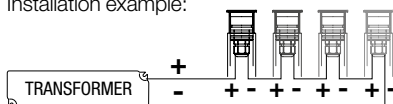

mira 40



LED



...brz



...inx

art.

5411
5421
5431

design Ufficio Tecnico Landa



5411



code ...L1
...L3

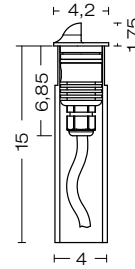

5421



code ...L1
...L3

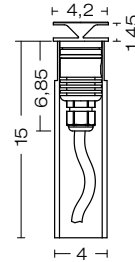

5431





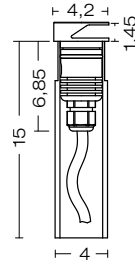

code ...L1
...L3



corpo alluminio estruso
anodizzato
body in extruded anodized
aluminium
corps en aluminium extrudé
anodisé
cuerpo en aluminio extrusionado
y anodizado
Körper aus eloxiertem
fließgepresst Aluminium

diffusore vetro opale
diffuser glass opal
diffuser verre opale
difusor vidrio ópalo
Diffuser Glas opal





art.	art.	art.		W	mA	Type	
5411L1	5421L1	5431L1		1	350	6000°K 110LM	
5411L1H	5421L1H	5431L1H				3000°K 90LM	

Accessories on request:

electronic Transformer from **1 to 2 LED** cod. 0409BT012 - 20V 350mA IP67

electronic Transformer from **3 to 12 LED** cod. 0409BT009 - 48V 350mA IP67

5411L3	5421L3	5431L3		3	700	6000°K 190LM	
5411L3H	5421L3H	5431L3H				3000°K 150LM	

Accessories on request:

electronic Transformer from **1 to 2 LED** cod. 0409BT011 - 11V 700mA IP67

electronic Transformer from **3 to 12 LED** cod. 0409BT010 - 48V 700mA IP67

For technical details visit
www.landa.it



ELECTRIFICATION



dettagli / details / details
detalles / details:
pages 4-5

Installation example:

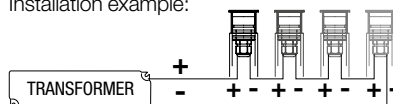

mira 40



LED

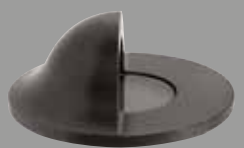

...brz

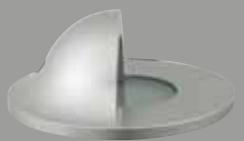

...inx

LED
powered by
SEOUL® LED

simmetrico
symmetric
symétriques
simétrico
symmetrisch

example code:
| art. | LED |  | anodized |
5301 LS3 H inx

art.
5301

design Ufficio Tecnico Landa

corpo alluminio estruso
anodizzato
body in extruded anodized
aluminium
corps en aluminium extrudé
anodisé
cuerpo en aluminio
extrusionado y anodizado
Körper aus eloxiertem
fließgepresst Aluminium

diffusore vetro trasparente
e opale
diffuser glass transparent
and opal
diffuser verre transparent
et opale
difusor vidrio transparente
y ópalo
Diffuser Glas klar un opal



5301LS



10°

code ...LS3
...LS7



5301LL



40°

code ...LL3
...LL7







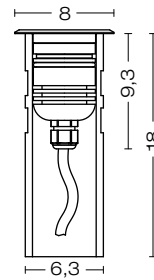

5301L





code ...L3
...L7



art.		art.		art.		W	mA	Type	
5301LS3	10°	5301LL3	40°	5301L3		3	350	6000°K 330LM	
5301LS3H		5301LL3H		5301L3H				3000°K 270LM	

Accessories on request:

electronic Transformer for **1 LED** cod. 0409BT012 – 20V 350mA IP67
electronic Transformer from **2 to 4 LED** cod. 0409BT009 – 48V 350mA IP67

5301LS7	10°	5301LL7	40°	5301L7		7	700	6000°K 570LM	
5301LS7H		5301LL7H		5301L7H				3000°K 450LM	

Accessories on request:

electronic Transformer for **1 LED** cod. 0409BT011 – 11V 700mA IP67
electronic Transformer from **2 to 4 LED** cod. 0409BT010 – 48V 700mA IP67



For technical details visit
www.landa.it



ELECTRIFICATION

LED

dettagli / details / details
detalles / details:
pages 4-5

Installation example:

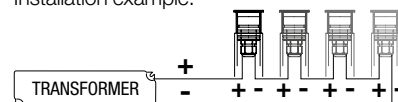

mira 60



LED



...brz



...inx

serie/series

mira 60

NEW

LED

powered by
SEOUL® LED

example code:

| art. | LED |  | anodized |
5311 | L7 | H | brz

art.

5311

design Ufficio Tecnico Landa



5311





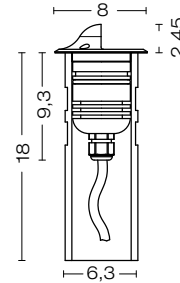

code ...L3
...L7



corpo alluminio estruso
anodizzato
*body in extruded anodized
aluminium*
corps en aluminium extrudé
anodisé
*cuerpo en aluminio
extrusionado y anodizado*
*Körper aus eloxiertem
fließgepresst Aluminium*



diffusore vetro opale
diffuser glass opal
diffuser verre opale
difusor vidrio ópalo
Diffuser Glas opal



art.		W	mA	Type 
5311L3		3	350	6000°K 330LM
5311L3H				3000°K 270LM

Accessories on request:

electronic Transformer for **1 LED** cod. 0409BT012 – 20V 350mA IP67
electronic Transformer from **2 to 4 LED** cod. 0409BT009 – 48V 350mA IP67

5311L7		7	700	6000°K 570LM
5311L7H				3000°K 450LM

Accessories on request:

electronic Transformer for **1 LED** cod. 0409BT011 – 11V 700mA IP67
electronic Transformer from **2 to 4 LED** cod. 0409BT010 – 48V 700mA IP67

For technical details visit
www.landa.it



ELECTRIFICATION

LED

dettagli / details / details
detalles / details:
pages 4-5

Installation example:

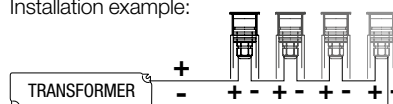

mira 60



LED

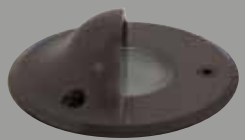

...brz

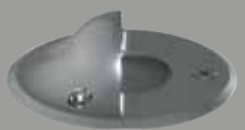

...inx

wall mira 40

NEW

LED
powered by
SEOUL® LED

example code:
| art. | LED |  | anodized |
4191 | L3 | H | inox

art.





4191
4192
4193
4194

design Ufficio Tecnico Landa

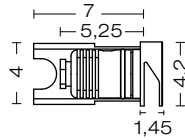
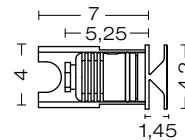
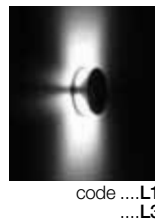
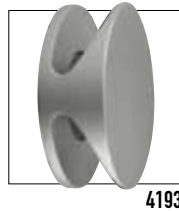
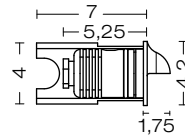
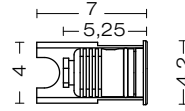
corpo alluminio estruso
anodizzato
body in extruded anodized
aluminium
corps en aluminium extrudé
anodisé
cuerpo en aluminio
extrusionado y anodizado
Körper aus eloxiertem
fließgepresst Aluminium

diffusore vetro opale
diffuser glass opal
diffuser verre opale
difusor vidrio ópalo
Diffuser Glas opal





art.	art.	art.	art.		W	mA	Type	
4191L1	4192L1	4193L1	4194L1		1	350	6000°K 110LM	
4191L1H	4192L1H	4193L1H	4194L1H		1	350	3000°K 90LM	

Accessories on request:

electronic Transformer from **1 to 2 LED** cod. 0409BT012 – 20V 350mA IP67

electronic Transformer from **3 to 12 LED** cod. 0409BT009 – 48V 350mA IP67

4191L3	4192L3	4193L3	4194L3		3	700	6000°K 190LM	
4191L3H	4192L3H	4193L3H	4194L3H		3	700	3000°K 150LM	

Accessories on request:

electronic Transformer from **1 to 2 LED** cod. 0409BT011 – 11V 700mA IP67

electronic Transformer from **3 to 12 LED** cod. 0409BT010 – 48V 700mA IP67



For technical details visit
www.landa.it

IP66 

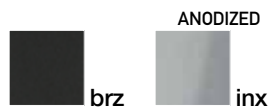

ELECTRIFICATION

LED

dettagli / details / details
detalles / details:
pages 4-5

Installation example:

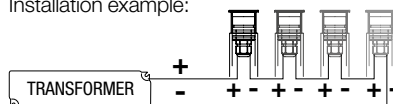



LED



...brz

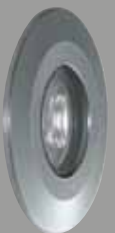

...inx

wall mira 60

NEW

LED

powered by
SEOUL® LED

example code:

| art. | LED |  | anodized |
4195 | L3 | H | brz

art.

4195

4196

design Ufficio Tecnico Landa

corpo alluminio estruso
anodizzato
body in extruded anodized
aluminium
corps en aluminium extrudé
anodisé
cuerpo en aluminio
extrusionado y anodizado
Körper aus eloxiertem
fließgepresst Aluminium

diffusore vetro opale
diffuser glass opal
diffuser verre opale
difusor vidrio ópalo
Diffuser Glas opal



4195



code ...L3
...L7

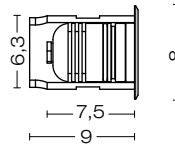





4196

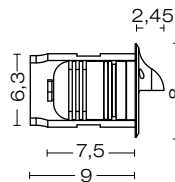

code ...L3
...L7





art.	art.		W	mA	Type 
4195L3	4196L3		3	350	6000°K 330LM
4195L3H	4196L3H				3000°K 270LM

Accessories on request:

electronic Transformer for **1 LED** cod. 0409BT012 - 20V 350mA IP67

electronic Transformer from **2 to 4 LED** cod. 0409BT009 - 48V 350mA IP67

4195L7	4196L7		7	700	6000°K 570LM
4195L7H	4196L7H				3000°K 450LM

Accessories on request:

electronic Transformer for **1 LED** cod. 0409BT011 - 11V 700mA IP67

electronic Transformer from **2 to 4 LED** cod. 0409BT010 - 48V 700mA IP67

For technical details visit
www.landa.it

IP66 



ELECTRIFICATION

LED

dettagli / details / details
detalles / details:
pages 4-5

Installation example:

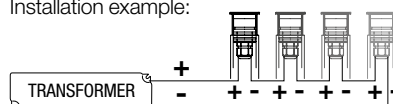



LED



...brz



...inx

brick light

NEW

LED

powered by
Citizen Electronics® LED
Transformer included

simmetrico
symmetric
symétriques
simétrico
symmetrisch

example code:

art. LED colour
410 L3 H ngg

art. electrification colour
410 PL9 ngg

art.
410
411
412
413



410 / 410M



411 / 411M

frontale in alluminio /
aluminium frame /
cadre en aluminium
cornis aluminio /
Rahmen aus Aluminium

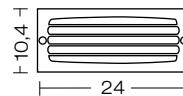
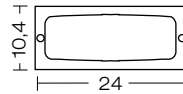

design Ufficio Tecnico Landa



ngg



bgg



all

COLOURS

corpo alluminio pressofuso
body in die casting aluminium
corps en aluminium moulé
sous pression
cuerpo aluminio inyectado
Körper aus Aluminium-
Druckguss



412 / 412M



413 / 413M

frontale in acciaio
inox AISI 316L /
stainless steel AISI
316L frame / cadre
en acier inoxydable
AISI 316L / cornis
acero inox AISI 316L
/ Rahmen aus
Edelstahl AISI 316L

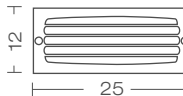

diffusore vetro opale
diffuser glass opal
diffuser verre opale
difusor vidrio ópalo
Diffuser Glas opal

BOX DIMENSION

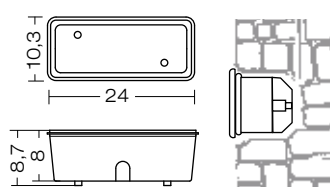

code 410 - 411 - 412 - 413

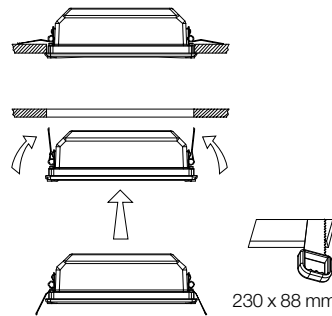

code 410..M - 411..M - 412..M - 413..M

For technical details visit
www.landa.it

IP54

art.	art.	art.	art.	art.	art.	art.	art.		W	V	Type	
410L3	411L3	412L3	413L3	410L3M	411L3M	412L3M	413L3M	○			5000°K	490LM
410L3H	411L3H	412L3H	413L3H	410L3HM	411L3HM	412L3HM	413L3HM	○	5,5	240	2900°K	370LM
410L3B	411L3B	412L3B	413L3B	410L3BM	411L3BM	412L3BM	413L3BM	●				58LM
410L3R	411L3R	412L3R	413L3R	410L3RM	411L3RM	412L3RM	413L3RM	●				200LM
410	411	412	413	410M	411M	412M	413M		1x23			E27
410PL9	411PL9	412PL9	413PL9	410PL9M	411PL9M	412PL9M	413PL9M		1x9			G23
410F13	411F13	412F13	413F13	410F13M	411F13M	412F13M	413F13M		1x13			G24 q-1

ELECTRIFICATION
LED

dettagli /
details / details
detales / details:
pages 4-5



codeL3

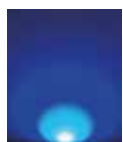

codeL3B

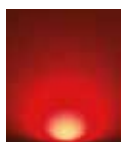

codeL3R

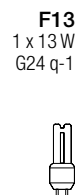
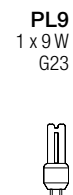
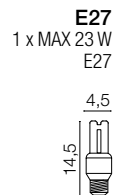

brick light



LED



serie/series

brick light

NEW

LED

powered by
Citizen Electronics® LED
Transformer included



asimmetrico
asymmetric
asymétriques
asimétrico
asymmetrisch

example code:

| art. | LED | ○ | colour |
414 L5 H nhg

art.

414

design Ufficio Tecnico Landa

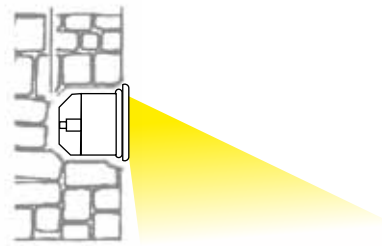
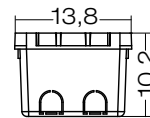
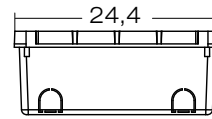
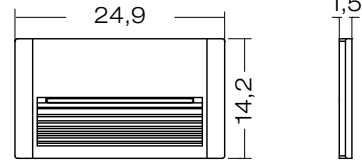

corpo alluminio pressofuso
body in die casting aluminium
corps en aluminium moulé
sous pression
cuerpo aluminio inyectado
Körper aus Aluminium-
Druckguss

diffusore policarbonato opale
diffuser opal polycarbonate
diffuser polycarbonate opale
difusor policarbonato ópalo
Diffuser Polykarbonat opal

For technical details visit
www.landa.it

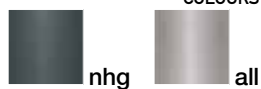

art.		W	V	Type	
414F18		18	240	G24 q-2	
414F26		26	240	G24 q-3	
414L5	○	5,5	240	5000°K	490LM
414L5H	○			2900°K	370LM
414L12	○	12	240	5000°K	1440LM
414L12H	○			2900°K	1000LM

ELECTRIFICATION

LED

dettagli /
details / details
detalles / detalles:
pages 4-5



code ...L5
... L12

F18
1 x 18 W
G24 q-2

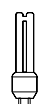

F26
1 x 26 W
G24 q-3

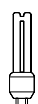

brick light



LED





simmetrico
symmetric
symétriques
simétrico
symmetrisch



asimmetrici aggiustabili
Adjustable reflectors
asymétriques ajustables
Refletores ajustables
asymmetrisch und regelbar

example code:

| art. | electrification | colour |
550 H70 all

art.

550

design Teseo Berghella

OHIM:
patent No.
000659917-0001



550H70

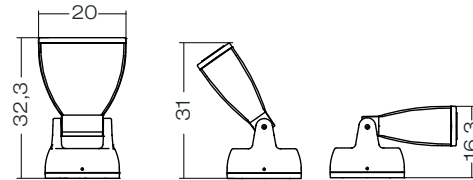

corpo alluminio pressofuso
body in die casting aluminium
corps en aluminium moulé
sous pression
cuerpo aluminio inyectado
Körper aus Aluminium-
Druckguss



550VH70

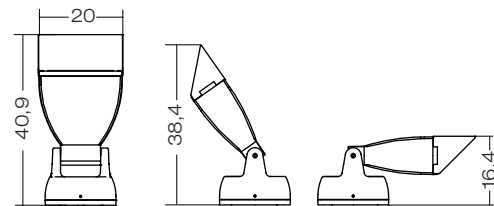

diffusore vetro trasparente
diffuser glass transparent
diffuser verre transparent
difusor vidrio transparente
Diffuser Glas klar

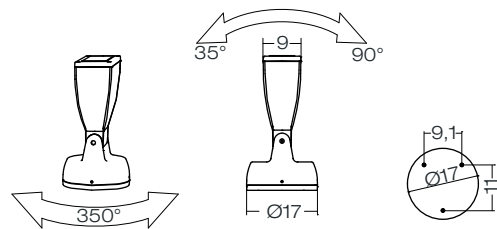

For technical details visit
www.landa.it



IP65

COLOURS

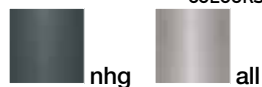

ELECTRIFICATION

H70
1 x 70 W
RX7s
metal halide

Colored Bulb - BLV
visit: www.blv-licht.com

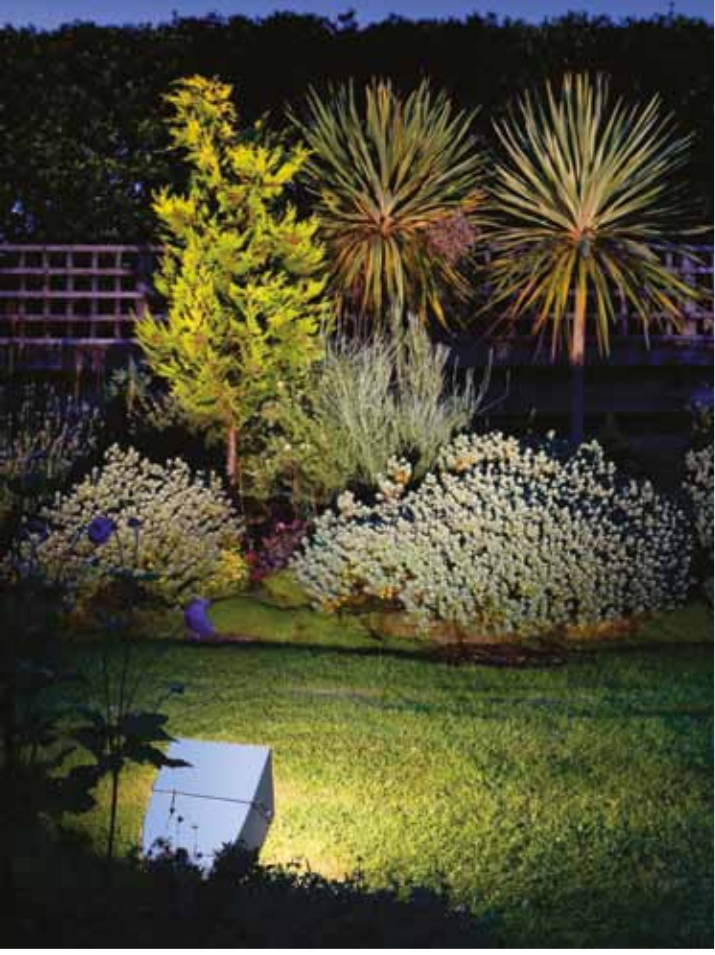

Accessories on request:

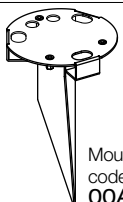

Mounting spike
code **00A550P**

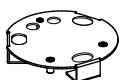

Mounting plate
code **00A550R**

LED

powered by Acriche
SEOUL® LED

AC direct connection

230/240V

Transformer not required



simmetrico
symmetric
symétriques
simétrico
symmetrisch

example code:

art. **LED 40°** colour
455 LL12X1 H all

art. **LED 40°** colour
455 LL16X2 H nhg

art.

455

design Ufficio Tecnico Landa

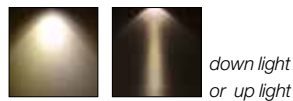
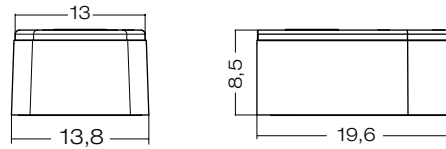

down light
or up light

corpo alluminio pressofuso
body in die casting aluminium
corps en aluminium moulé
sous pression
cuerpo aluminio inyectado
*Körper aus Aluminium-
Druckguss*

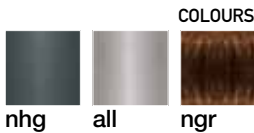

COLOURS

nhg all ngr

art.		W	V	Type		LUX 1mt
455LS12X1	12°	12	240	6000°K 780LM		4500
455LS12X1H	12°	12	240	3500°K 660LM		3800
455LL12X1	40°	12	240	6000°K 780LM		1200
455LL12X1H	40°	12	240	3500°K 660LM		1020

diffusore Vetro e
PMMA trasparente
*diffuser glass and PMMA
transparent*
diffuser verre et PMMA
transparent
difusor vidrio y PMMA
transparente
Diffuser Glas und PMMA klar

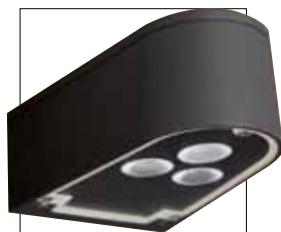

up and
down light

art.		W	V	Type		LUX 1mt
455LS16X2	12°	4 12	240	6000°K 300LM 6000°K 780LM		1540 4500
455LS16X2H	12°	4 12	240	3500°K 250LM 3500°K 660LM		1300 3800
455LL16X2	40°	4 12	240	6000°K 300LM 6000°K 780LM		440 1200
455LL16X2H	40°	4 12	240	3500°K 250LM 3500°K 660LM		370 1020
455LMA16X2	12° 40°	4 12	240	6000°K 300LM 6000°K 780LM		1540 1200
455LMA16X2H	12° 40°	4 12	240	3500°K 250LM 3500°K 660LM		1300 1020
455LMB16X2	40° 12°	4 12	240	6000°K 300LM 6000°K 780LM		440 4500
455LMB16X2H	40° 12°	4 12	240	3500°K 250LM 3500°K 660LM		370 3800

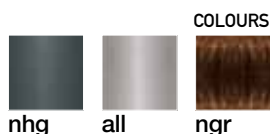

COLOURS

nhg all ngr

For technical details visit
www.landa.it



ELECTRIFICATION

LED

dettagli /
details / details
detales / details:
pages 4-5

Transformer not required
12° 40°

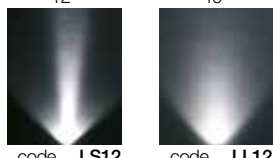

codeLS12

codeLL12

dolby



LED

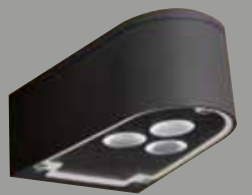

LED

powered by
SEOUL® LED
Transformer included

simmetrico
symmetric
symétriques
simétrico
symmetrisch

example code:

art. LED 10° colour
465 LS3X1 H nhg

art. electrification colour
465 GU10X2 nhg

art.

465

design A. Dolcetti

OHIM:
patent No.
000346366-0003

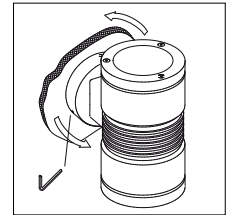
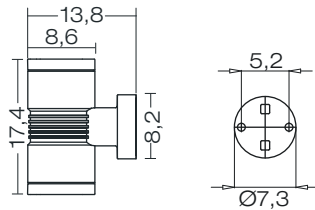

EASY INSTALLATION

corpo alluminio pressofuso
body in die casting aluminium
corps en aluminium moulé
sous pression
cuerpo aluminio inyectado
Körper aus Aluminium-
Druckguss

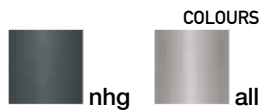
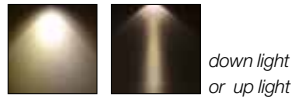

diffusore vetro trasparente
diffuser glass transparent
diffuser verre transparent
difusor vidrio transparente
Diffuser Glas klar

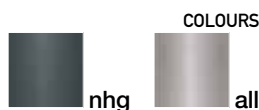

art.	Beam	W	V	Type	Light	LUX 1mt
465LS3X1	○			6300°K	300LM	3950
465LS3X1H	○			3200°K	240LM	3120
465LS3X1B	●	1 x 3	240		66LM	900
465LS3X1R	●				144LM	1900
465LL3X1	○			6300°K	300LM	400
465LL3X1H	○			3200°K	240LM	312
465LL3X1B	●	1 x 3	240		66LM	90
465LL3X1R	●				144LM	190
465GU10X1	☒	1 x 14		Megaman GU10		
		1 x 7		Master spot led GU10		
465GU5.3X1	☒	1 x 35	12	halogen GU5,3		
		1 x 4		Master spot led GU5,3		

art.	Beam	W	V	Type	Light	LUX 1mt
465LS3X2	○			6300°K	300LM	3950
465LS3X2H	○			3200°K	240LM	3120
465LS3X2B	●	2 x 3	240		66LM	900
465LS3X2R	●				144LM	1900
465LL3X2	○			6300°K	300LM	400
465LL3X2H	○			3200°K	240LM	312
465LL3X2B	●	2 x 3	240		66LM	90
465LL3X2R	●				144LM	190
465LM3X2	○			6300°K	300LM	3950/400
465LM3X2H	○			3200°K	240LM	3120/312
465LM3X2B	●	2 x 3	240		66LM	900/90
465LM3X2R	●				144LM	1900/190
465GU10X2	☒	2 x 7		Megaman GU10		
		2 x 3		Master spot led GU10		
465GU5.3X2	☒	2 x 35	12	halogen GU5,3		
		2 x 4		Master spot led GU5,3		

For technical details visit
www.landa.it

IP66

ELECTRIFICATION
LED
dettagli /
details / details
detales / details:
pages 4-5

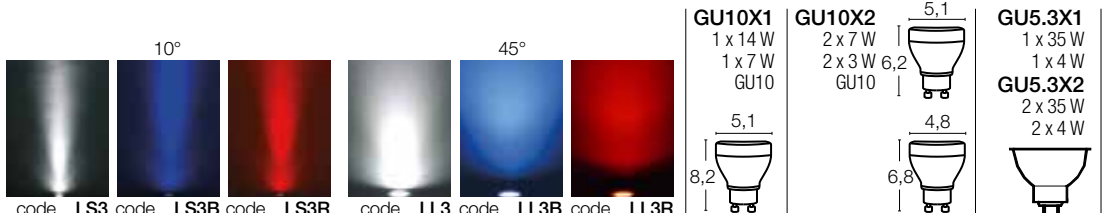

lyras 80



LED



Accessories on request:



code **00K465.02**
Reflector for art. **465**



code **00K465.01**
Visor for art. **465**

serie/series

lyras 80

NEW

LED

powered by
SEOUL® LED
Transformer included

simmetrico
symmetric
symétriques
simétrico
symmetrisch

example code:

| art. | LED 10° | ○ | colour |
466 LS3 H all

| art. | electrification | colour |
466 GU10 all

art.
466
467
468

design A. Dolcetti

OHIM:
patent No.
000346366-0003



466



467

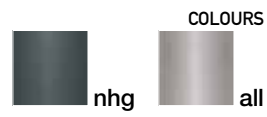
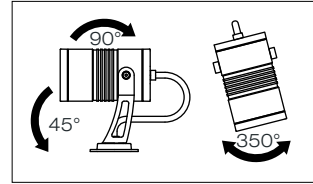
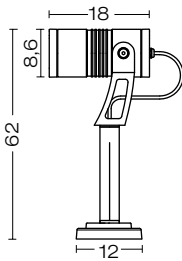
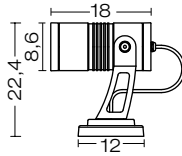

corpo alluminio pressofuso
body in die casting aluminium
corps en aluminium moulé
sous pression
cuerpo aluminio inyectado
Körper aus Aluminium-
Druckguss

diffusore vetro trasparente
diffuser glass transparent
diffuser verre transparent
difusor vidrio transparente
Diffuser Glas klar



468

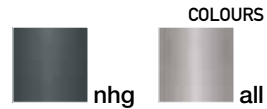
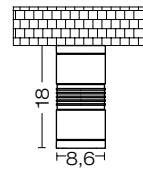

For technical details visit
www.landa.it

IP66

art.	art.	art.		W	V	Type	LUX at 1 mt
466LS3	467LS3	468LS3	○	10°	3	240	6300°K 240LM 3180
466LS3H	467LS3H	468LS3H	○				3200°K 190LM 2500
466LS3B	467LS3B	468LS3B	●				66LM 900
466LS3R	467LS3R	468LS3R	●				144LM 1900
466LL3	467LL3	468LL3	○	45°	3	240	6300°K 240LM 320
466LL3H	467LL3H	468LL3H	○				3200°K 190LM 250
466LL3B	467LL3B	468LL3B	●				66LM 90
466LL3R	467LL3R	468LL3R	●				144LM 190
466GU10	467GU10	468GU10		1 x 14	12	Megaman GU10	
				1 x 7		Master spot led GU10	
466GU5.3	467GU5.3	468GU5.3		1 x 35	12	halogen GU5,3	
				1 x 4		Master spot led GU5,3	

ELECTRIFICATION

LED

dettagli /
details / details
detalles / detalles:
pages 4-5

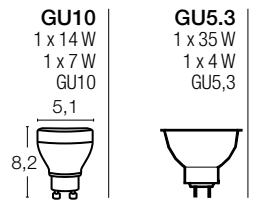
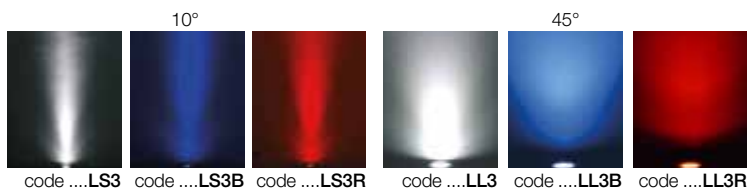

lyras 80



LED

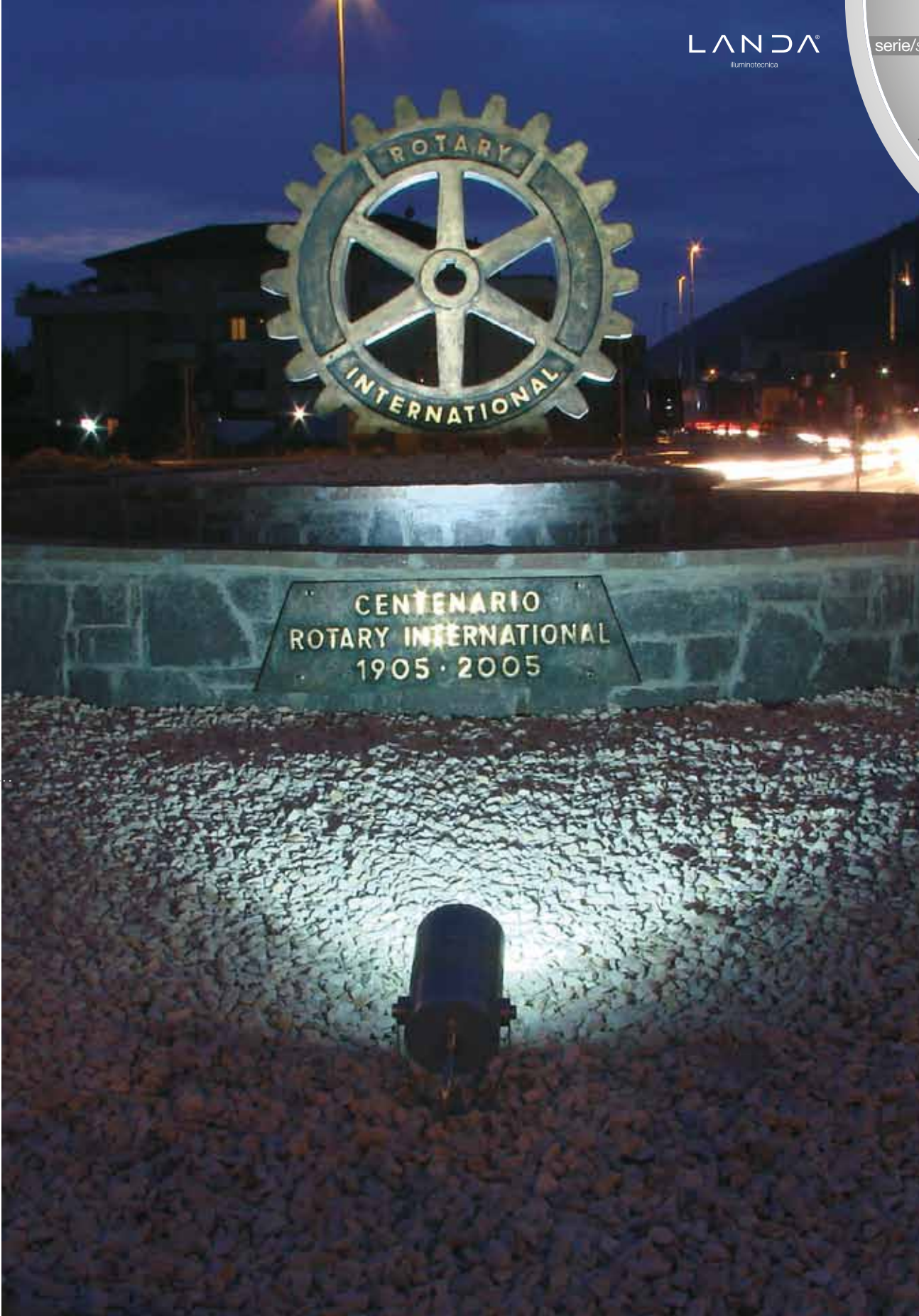

Accessories on request:



code **00K465.02**
Reflector for
art. **466-467-468**



code **00A465**
Mounting spike for
art. **466-467**



code **00K465.01**
Visor for
art. **466-467-468**

lyras 130

NEW

LED

powered by Acriche SEOUL® LED

AC direct connection  230/240V

Transformer not required

example code:

 art. LED 12°  colour
460 LS12X1 H all

 art. electrification  colour
460 G9 rnhg

art.







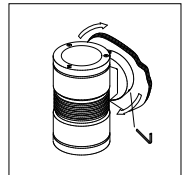
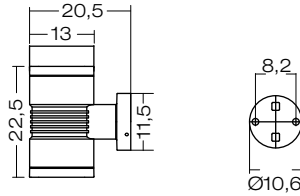





460

















design A. Dolcetti

OHIM:
patent No.
000346366-0003



EASY INSTALLATION

art.		W	V	Type		LUX at 1mt
460LS12X1		1 x 12	240	6000°K	780LM	4000
460LS12X1H				3500°K	660LM	3400
460LL12X1		1 x 12	240	6000°K	780LM	850
460LL12X1H				3500°K	660LM	700
460F18		1 x 18			TC-T / GX24 q-2	
460GU10X1		1 x 50			GU10	
460GU5.3X1		1 x 50	12	no transformer	GU5,3	
460BT50X1		1 x 50		with transformer	GU5,3	
460G9X1		1 x 60			G9	
460H20X1		1 x 20			PGJ5	
460H20X1S		1 x 20			PGJ5	

art.		W	V	Type		LUX at 1mt
460LS12X2		2 x 12	240	6000°K	780LM	4000
460LS12X2H				3500°K	660LM	3400
460LL12X2		2 x 12	240	6000°K	780LM	850
460LL12X2H				3500°K	660LM	700
460LM12X2		2 x 12	240	6000°K	780LM	4000/850
460LM12X2H				3500°K	660LM	3400/700
460G9		1 x 75			G9	
460B15D		1 x 150			B15d	
460GU10X2		2 x 50			GU10	
460GU5.3X2		2 x 50	12	no transformer	GU5,3	
460BT50X2		2 x 50		with transformer	GU5,3	
460G9X2		2 x 60			G9	
460H20X2		2 x 20			PGJ5	
460H20X2S		2 x 20			PGJ5	
460H20X2M		2 x 20			PGJ5	

corpo alluminio pressofuso
body in die casting aluminium
corps en aluminium moulé
sous pression
cuerpo aluminio inyectado
Körper aus Aluminium-
Druckguss

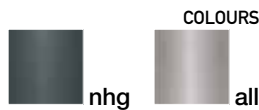
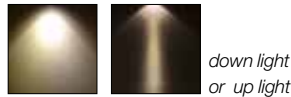

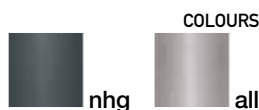

diffusore vetro trasparente
diffuser glass transparent
diffuser verre transparent
difusor vidrio transparente
Diffuser Glas klar



For technical details visit
www.landa.it

IP66 

ELECTRIFICATION
LED
dettagli /
details / details
détalles / details:
pages 4-5

Transformer not required
12° 40°
 
codeLS12 codeLL12

F18
1x18 W
Gx24 q-2

GU10X2
1x50 W
GU10X2
2x50 W
GU10

GU5.3X1
BT50X1
1x50 W
GU5.3X2
BT50X2
2x50 W
GU5,3

G9X1
1x60 W
G9X2
1x60 W
G9

H20X1
H20X1S
1x20 W
H20X2
H20X2S
H20X2M
2x20 W
PGJ5

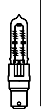
B15D
1x150 W
B15d



LED



Accessories on request:

Also available with:



cod. **0201008B**
vetro opale/opal glass/
verre opale/vidrio ópalo/
Glas opal



code **00K460.02**
Reflector for art. **460**



code **00K460.01**
Visor for art. **460**

LED

powered by Acriche SEOUL® LED

AC direct connection  230/240V

Transformer not required

example code:

| art. | LED 12° |  | colour |
461 LS12 H all

| art. | electrification | colour |
461 F18 all

art.
461
462
463

design A. Dolcetti

OHIM:
patent No.
000346366-0003



461

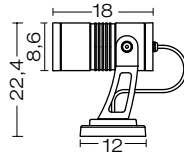

462

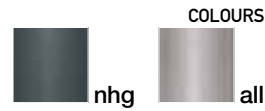
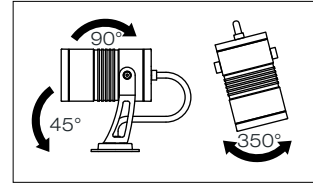
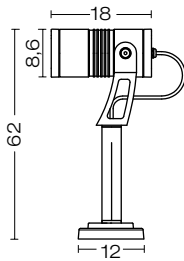

corpo alluminio pressofuso
body in die casting aluminium
corps en aluminium moulé
sous pression
cuerpo aluminio inyectado
Körper aus Aluminium-
Druckguss

diffusore vetro trasparente
diffuser glass transparent
diffuser verre transparent
difusor vidrio transparente
Diffuser Glas klar





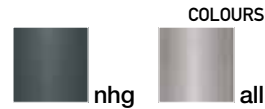
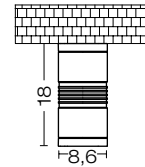







463



For technical details visit
www.landa.it

IP66 

art.	art.	art.		W	V	Type		LUX 1mt
461LS12X1	462LS12X1	463LS12X1		12	240	6000°K	780LM	4000
461LS12X1H	462LS12X1H	463LS12X1H				3500°K	660LM	3400
461LL12X1	462LL12X1	463LL12X1		12	240	6000°K	780LM	850
461LL12X1H	462LL12X1H	463LL12X1H				3500°K	660LM	700
461F18	462F18	463F18	-60°/+60°	1 x 18		TC-T / GX24 q-2		
461GU5.3	462GU5.3	463GU5.3		1 x 50	12	no transformer	GU5,3	
461E27	462E27	463E27	-60°/+60°	1 x 21			E27	
461H20	462H20	463H20	-30°/+30°	1 x 20			PGJ5	
461H20S	462H20S	463H20S	-5°/+5°	1 x 20			PGJ5	

ELECTRIFICATION

LED

dettagli /
details / details
détalles / details:
pages 4-5

Transformer not required



codeLS12



codeLL12

F18
1 x 18 W
Gx24
q-2

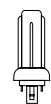

GU5.3
1 x 50 W
GU5,3



E27
1 x 21 W
E27



H20
H 20S
1 x 20 W
PGJ5

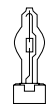

Lyras 130



LED



Accessories on request:

Also available with:



cod. **0201008B**
vetro opale/opal glass/
verre opale/vidrio ópalo/
Glas opal



code **00K460.02**
Reflector for
art. **461-462-463**



code **00A465**
Mounting spike for
art. **461-462**



code **00K460.01**
Visor for
art. **461-462-463**

LED
powered by
SEOUL® LED

simmetrico
symmetric
symétriques
simétrico
symmetrisch

example code:
| art. | LED |  | anodized |
4691 | LS1 | H | brz

art.

4691

design Ufficio Tecnico Landa

corpo alluminio estruso
anodizzato
body in extruded anodized
aluminium
corps en aluminium extrudé
anodisé
cuerpo en aluminio
extrusionado y anodizado
Körper aus eloxiertem
fließgepresst Aluminium

diffusore vetro trasparente
e opale
diffuser glass transparent
and opal
diffuser verre transparent
et opale
difusor vidrio transparente
y ópalo
Diffuser Glas klar un opal







4691 inx

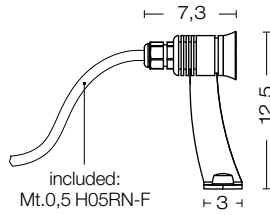

4691 brz



art.		art.		art.		W	mA	Type	
4691LS1	10°	4691LL1	40°	4691L1		1	350	6000°K	110LM
4691LS1H		4691LL1H		4691L1H				3000°K	90LM

Accessories on request:

electronic Transformer from **1 to 2 LED** cod. 0409BT012 – 20V 350mA IP67

electronic Transformer from **3 to 12 LED** cod. 0409BT009 – 48V 350mA IP67

art.		art.		art.		W	mA	Type	
4691LS3	10°	4691LL3	40°	4691L3		3	700	6000°K	190LM
4691LS3H		4691LL3H		4691L3H				3000°K	150LM

Accessories on request:

electronic Transformer from **1 to 2 LED** cod. 0409BT011 – 11V 700mA IP67

electronic Transformer from **3 to 12 LED** cod. 0409BT010 – 48V 700mA IP67



For technical details visit
www.landa.it



ELECTRIFICATION
LED
dettagli /
details / details
detalles / details:
pages 4-5

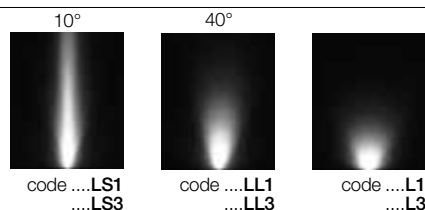

Installation example:

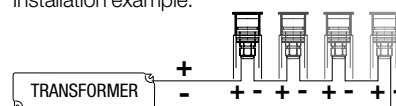

lyras 40



LED



code 00A469
Mounting spike

LED
powered by
SEOUL® LED

simmetrico
symmetric
symétriques
simétrico
symmetrisch

example code:
| art. | LED |  | anodized |
4695 LS3 H inx

art.
4695

design Ufficio Tecnico Landa

corpo alluminio estruso
anodizzato
body in extruded anodized
aluminium
corps en aluminium extrudé
anodisé
cuerpo en aluminio
extrusionado y anodizado
Körper aus eloxiertem
fließgepresst Aluminium

diffusore vetro trasparente
e opale
diffuser glass transparent
and opal
diffuser verre transparent
et opale
difusor vidrio transparente
y ópalo
Diffuser Glas klar un opal







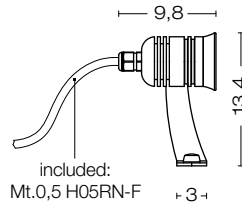

4695 inx





4695 brz



art.		art.		art.		W	mA	Type	
4695LS3	10°	4695LL3	40°	4695L3		3	350	6000°K 330LM	
4695LS3H		4695LL3H		4695L3H				3000°K 270LM	

Accessories on request:

electronic Transformer for **1 LED** cod. 0409BT012 - 20V 350mA IP67
electronic Transformer from **2 to 4 LED** cod. 0409BT009 - 48V 350mA IP67

4695LS7	10°	4695LL7	40°	4695L7		7	700	6000°K 570LM	
4695LS7H		4695LL7H		4695L7H				3000°K 450LM	

Accessories on request:

electronic Transformer for **1 LED** cod. 0409BT011 - 11V 700mA IP67
electronic Transformer from **2 to 4 LED** cod. 0409BT010 - 48V 700mA IP67

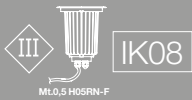

For technical details visit
www.landa.it

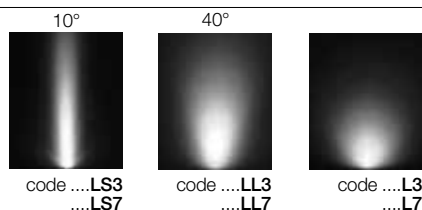

Installation example:

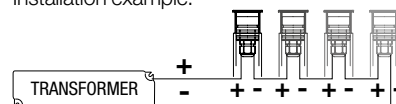

ELECTRIFICATION
LED
dettagli /
details / details
detalles / detalles:
pages 4-5

lyras 60



LED

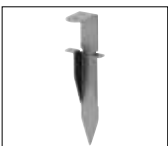

code 00A469
Mounting spike

serie/series

morphis

NEW

LED

powered by
Citizen Electronics® LED
Transformer included

example code:

| art. | LED |  | size | colour |
175 | L24 | H | .00 | ngg |

| art. | electrification | size | colour |
175 | F32 | .00 | ngr |

art.
175

designers Innocenzo Rifino
& Lorenzo Ruggieri

OHIM:
patent No.
001810037-001

Beijing - China
HC-IP Agency Co., LTD
patent No.
patent pending

corpo alluminio pressofuso
body in die casting aluminium
corps en aluminium moulé
sous pression
cuerpo aluminio inyectado
Körper aus Aluminium-
Druckguss

diffusore policarbonato
trasparente
diffuser transparent
polycarbonate
diffuser polycarbonate
transparent
difusor policarbonato
transparente
Diffuser Polykarbonat klar

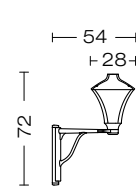

175.00
F32.00
H35.00
H70.00
L24.00
L24H.00



176.02
F32.02
H35.02
H70.02
L24.02
L24H.02

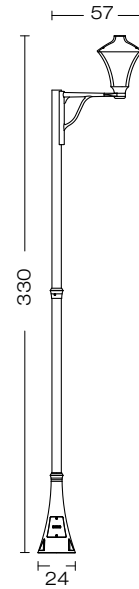

175.P1
F32.P1
H35.P1
H70.P1
L24.P1
L24H.P1

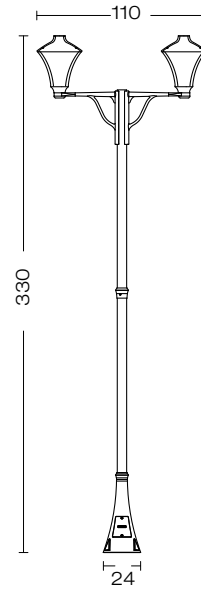

175.P2
F32.P2
H35.P2
H70.P2
L24.P2
L24H.P2

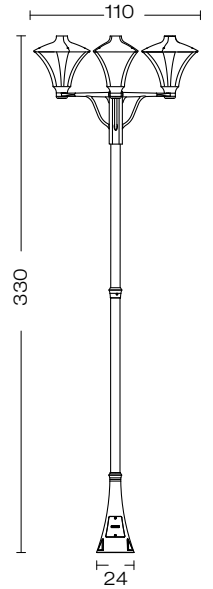

175.P3
F32.P3
H35.P3
H70.P3
L24.P3
L24H.P3

For technical details visit
www.landa.it

IP65



96°

COLOURS

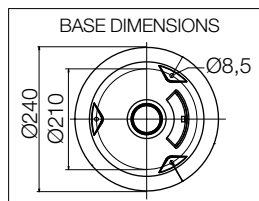
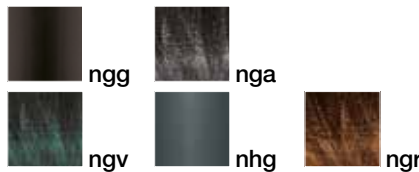

ELECTRIFICATION
LED
dettagli /
details / details
detalles / details:
pages 4-5

L24
LED 24 W
5000°K
2880LM
Ra65



L24H
LED 24 W
3000°K
1900LM
Ra85



E27
MAX 30 W

175.00
.P1
.P2
.P3

176.02

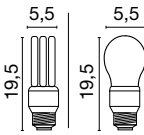

F32
32 W
Gx24 q-3



H35
1 x 35 W
G12
metal halide



H70
1x70 W
E27
metal halide



morphis



LED



Accessories on request:



code **0404M004**
Single connection IP68



code **0404M003**
Loop in loop out IP68

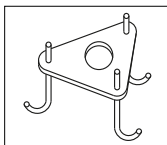

code **00A170.01P**
Anchor Bolt

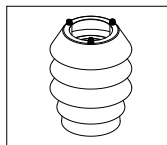

code **00KR175**
Only for: E27, F32, H35, H70

refrattore
refractor
réfracteur
refractor
Refraktor

LED

powered by
Citizen Electronics® LED
Transformer included

example code:

| art. | LED |  | size | colour |
176 | L24 | H | .02 | ngr

| art. | electrification | size | colour |
176 | F32 | .02 | ngr

art.
176

designers Innocenzo Rifino
& Lorenzo Ruggieri

OHIM:
patent No.
001810037-001

Beijing - China
HC-IP Agency Co., LTD
patent No.
patent pending

corpo alluminio pressofuso
body in die casting aluminium
corps en aluminium moulé
sous pression
cuerpo aluminio inyectado
Körper aus Aluminium-
Druckguss

diffusore policarbonato
trasparente
diffuser transparent
polycarbonate
diffuser polycarbonate
transparent
difusor policarbonato
transparente
Diffuser Polykarbonat klar

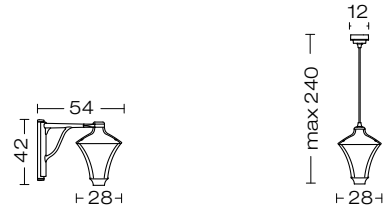

176.01
F32.01
H35.01
H70.01
L24.01
L24H.01

176.02
F32.02
H35.02
H70.02
L24.02
L24H.02

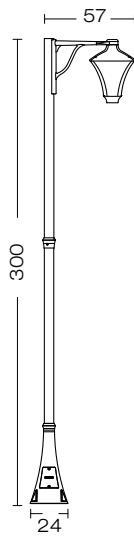

176.P1
F32.P1
H35.P1
H70.P1
L24.P1
L24H.P1

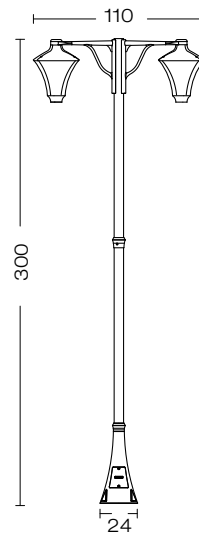

176.P2
F32.P2
H35.P2
H70.P2
L24.P2
L24H.P2

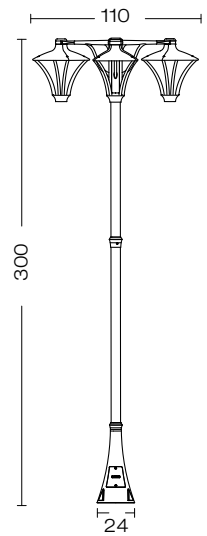

176.P3
F32.P3
H35.P3
H70.P3
L24.P3
L24H.P3

For technical details visit
www.landa.it

IP65

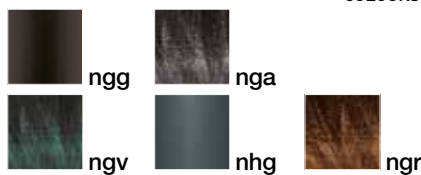

COLOURS

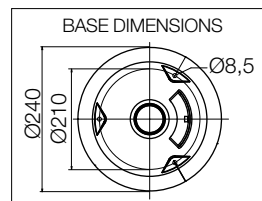

ELECTRIFICATION
LED
dettagli /
details / details
detalles / details:
pages 4-5

L24
LED 24 W
5000°K
2880LM
Ra65



L24H
LED 24 W
3000°K
1900LM
Ra85



E27
MAX 30 W

176.01
.02
.P1
.P2
.P3

F32
32 W
Gx24 q-3

H35
1 x 35 W
G12
metal halide

H70
1x70 W
E27
metal halide

morphis



LED



Accessories on request:



code **0404M004**
Single connection IP68



code **0404M003**
Loop in loop out IP68

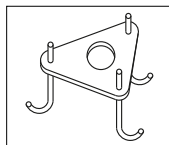

code **00A170.01P**
Anchor Bolt

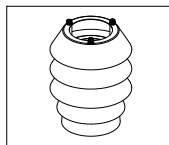

code **00KR175**
Only for: E27, F32, H35, H70

refrattore
refractor
réfracteur
refractor
Refraktor

serie/series

morphis

NEW

LED

powered by
Citizen Electronics® LED
Transformer included

example code:

art.	size	LED	○	colour
177	.095	L24	H	ngg

art.	size	electrification	colour
177	.095	F32	ngr

art.
177

designers Innocenzo Rifino
& Lorenzo Ruggieri

OHIM:
patent No.
001810037-001

Beijing - China
HC-IP Agency Co., LTD
patent No.
patent pending

corpo alluminio pressofuso
body in die casting aluminium
corps en aluminium moulé
sous pression
cuerpo aluminio inyectado
Körper aus Aluminium-
Druckguss

diffusore policarbonato
trasparente
diffuser transparent
polycarbonate
diffuser polycarbonate
transparent
difusor policarbonato
transparente
Diffuser Polykarbonat klar

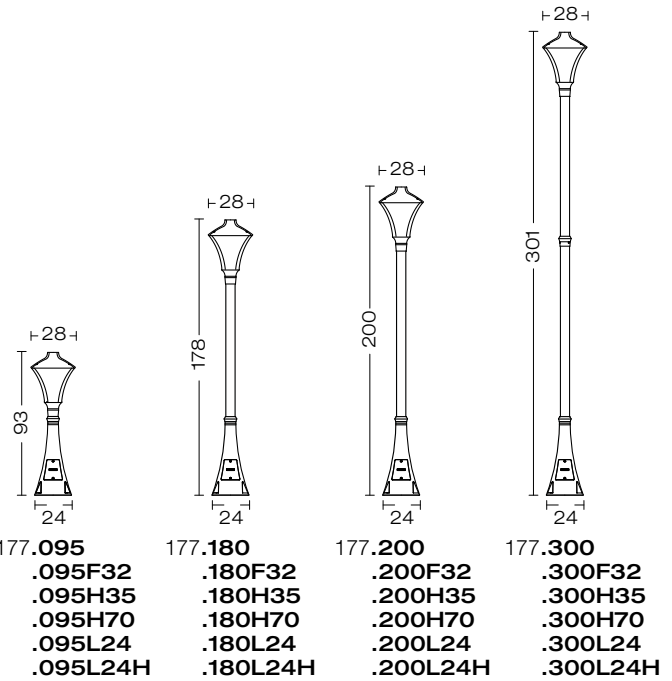
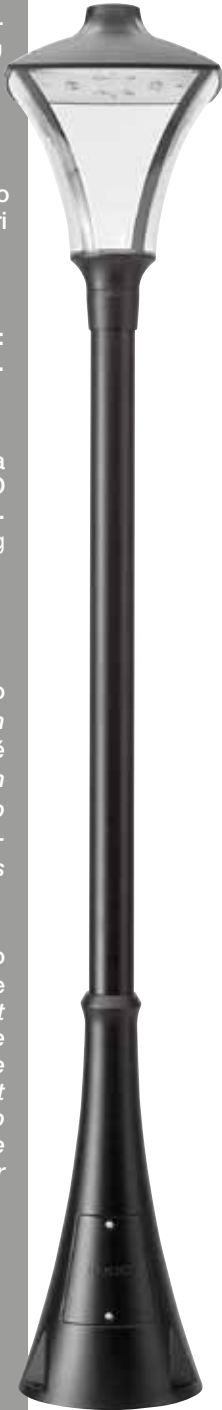

For technical details visit
www.landa.it

IP65



960°

COLOURS

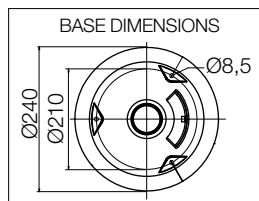
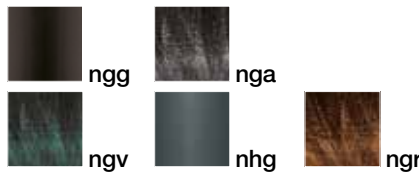

ELECTRIFICATION

LED

dettagli /
details / details
detalles / detalles:
pages 4-5

L24
LED 24 W
5000°K
2880LM
Ra65



L24H
LED 24 W
3000°K
1900LM
Ra85



177.095
.180
.200
.300

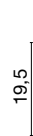

E27
MAX 30 W

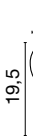

F32
32 W
Gx24 q-3



H35
1 x 35 W
G12
metal halide



H70
1x70 W
E27
metal halide





LED



Accessories on request:



code **0404M004**
Single connection IP68



code **0404M003**
Loop in loop out IP68

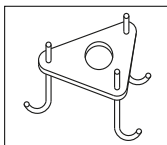

code **00A170.01P**
Anchor Bolt

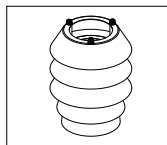

code **00KR175**

Only for: E27, F32, H35, H70

refrattore
refractor
réfracteur
refractor
Refraktor

serie/series

morphis

NEW

LED

powered by
Citizen Electronics® LED
Transformer included

example code:

| art. | LED |  | size | colour |
178 | L24 | H | .01 | ngg

art.

178

designers Innocenzo Rifino
& Lorenzo Ruggieri

OHIM:
patent No.
001810037-001

Beijing - China
HC-IP Agency Co., LTD
patent No.
patent pending

corpo alluminio pressofuso
body in die casting aluminium
corps en aluminium moulé
sous pression
cuerpo aluminio inyectado
Körper aus Aluminium-
Druckguss

diffusore policarbonato
trasparente
diffuser transparent
polycarbonate
diffuser polycarbonate
transparent
difusor policarbonato
transparente
Diffuser Polykarbonat klar

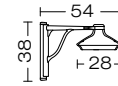

178L24.01
L24H.01

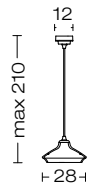

178L24.02
L24H.02

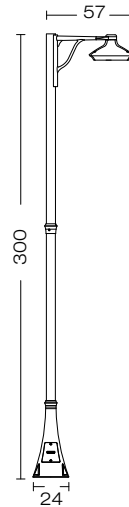

178L24.P1
L24H.P1

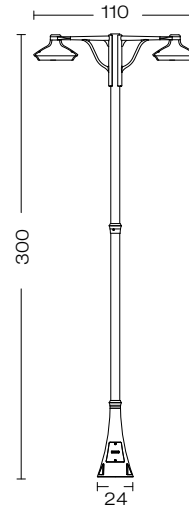

178L24.P2
L24H.P2

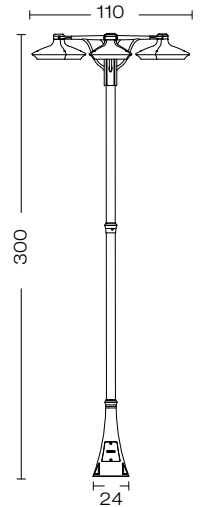

178L24.P3
L24H.P3

For technical details visit
www.landa.it

IP65



960°

COLOURS



ngg



nga



ngv



nhg



ngr

BASE DIMENSIONS

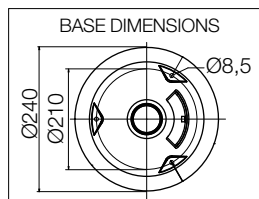

ELECTRIFICATION

LED

dettagli /
details / details
detalles / detalles:
pages 4-5

L24
LED 24 W
5000°K
2880LM
Ra65



L24H
LED 24 W
3000°K
1900LM
Ra85





LED



Accessories on request:



code **0404M004**
Single connection IP68



code **0404M003**
Loop in loop out IP68

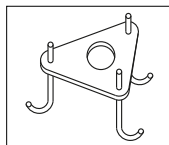

code **00A170.01P**
Anchor Bolt

serie/series

morphis

NEW

LED

powered by
Citizen Electronics® LED
Transformer included

example code:

| art. | LED |  | size | colour |
179 | L24 | H | .01 | ngg |

| art. | electrification | size | colour |
179 | F32 | F32 | .01 | ngr |

art.
179

designers Innocenzo Rifino
& Lorenzo Ruggieri

OHIM:
patent No.
001810037-001

Beijing - China
HC-IP Agency Co., LTD
patent No.
patent pending

corpo alluminio pressofuso
body in die casting aluminium
corps en aluminium moulé
sous pression
cuerpo aluminio inyectado
Körper aus Aluminium-
Druckguss

diffusore policarbonato
trasparente
diffuser transparent
polycarbonate
diffuser polycarbonate
transparent
difusor policarbonato
transparente
Diffuser Polykarbonat klar

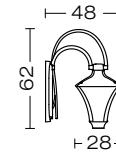
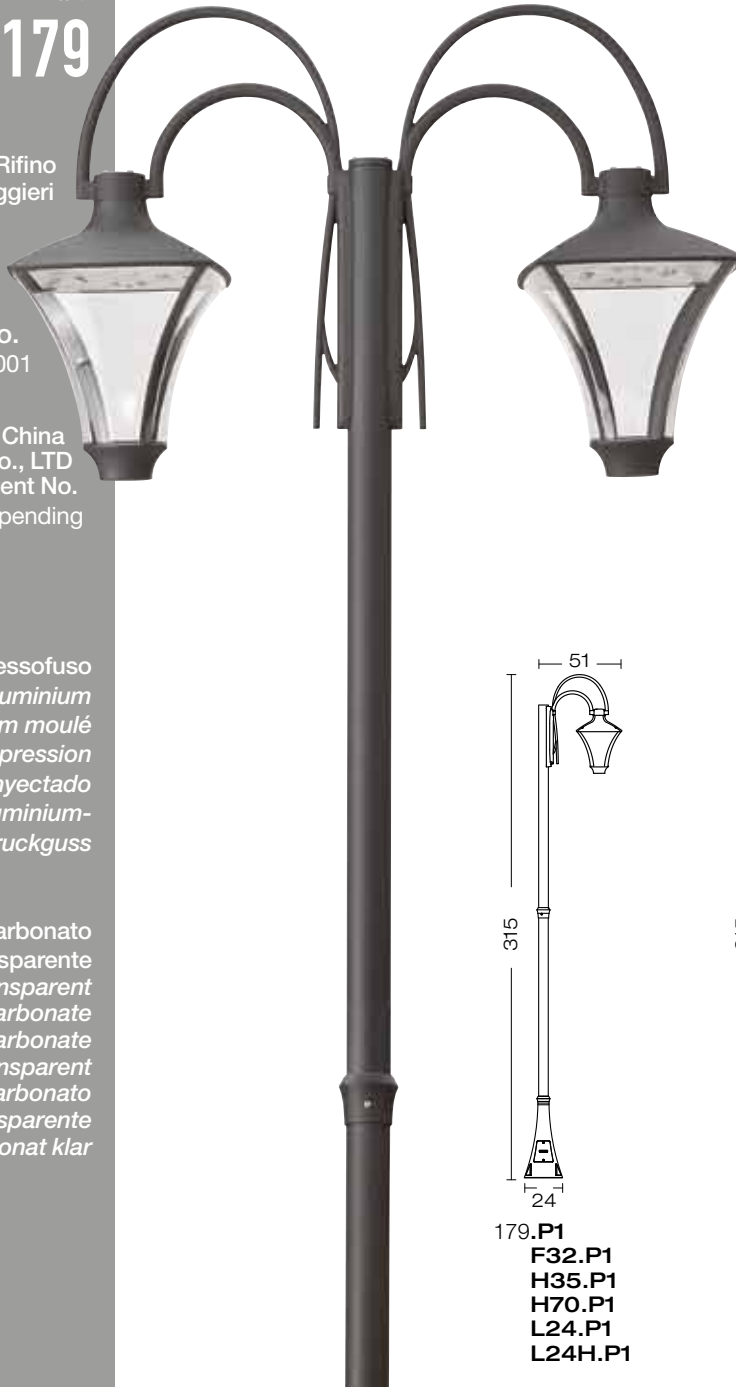

179.01
F32.01
H35.01
H70.01
L24.01
L24H.01



176.02
F32.02
H35.02
H70.02
L24.02
L24H.02

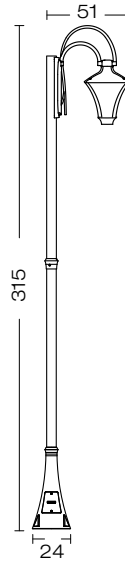

179.P1
F32.P1
H35.P1
H70.P1
L24.P1
L24H.P1

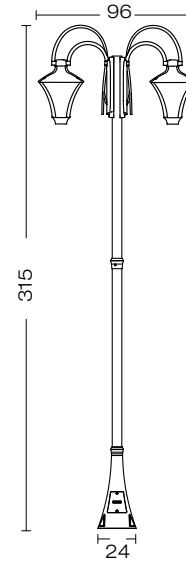

179.P2
F32.P2
H35.P2
H70.P2
L24.P2
L24H.P2

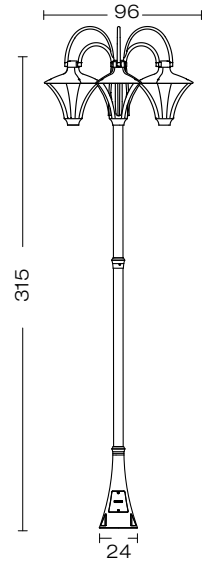

179.P3
F32.P3
H35.P3
H70.P3
L24.P3
L24H.P3

For technical details visit
www.landa.it

IP65



960°

COLOURS

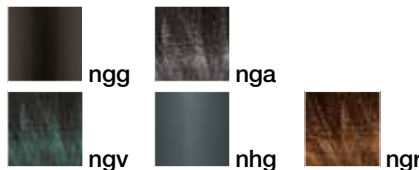

BASE DIMENSIONS

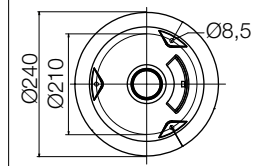

ELECTRIFICATION
LED
dettagli /
details / details
detalles / details:
pages 4-5

L24
LED 24 W
5000°K
2880LM
Ra65



L24H
LED 24 W
3000°K
1900LM
Ra85



E27
MAX 30 W

179.01
.P1
.P2
.P3
176.02

F32
32 W
Gx24 q-3

H35
1 x 35 W
G12
metal halide

H70
1x70 W
E27
metal halide



LED



Accessories on request:



code **0404M004**
Single connection IP68



code **0404M003**
Loop in loop out IP68

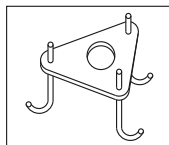

code **00A170.01P**
Anchor Bolt

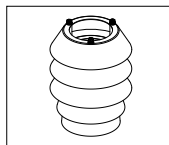

code **00KR175**
Only for: E27, F32, H35, H70

refrattore
refractor
refractor
réfracteur
refractor
Refraktor

serie/series

morphis

NEW

LED

powered by
Citizen Electronics® LED
Transformer included

example code:

| art. | LED |  | size | colour |
180 L24 H .01 ngg

art.
180

designers Innocenzo Rifino
& Lorenzo Ruggieri

OHIM:
patent No.
001810037-001

Beijing - China
HC-IP Agency Co., LTD
patent No.
patent pending

corpo alluminio pressofuso
body in die casting aluminium
corps en aluminium moulé
sous pression
cuerpo aluminio inyectado
Körper aus Aluminium-
Druckguss

diffusore policarbonato
trasparente
diffuser transparent
polycarbonate
diffuser polycarbonate
transparent
difusor policarbonato
transparente
Diffuser Polykarbonat klar

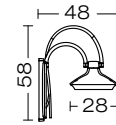

180L24.01
L24H.01



178L24.02
L24H.02

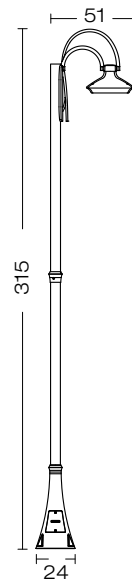

180L24.P1
L24H.P1

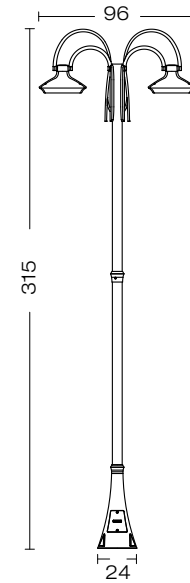

180L24.P2
L24H.P2

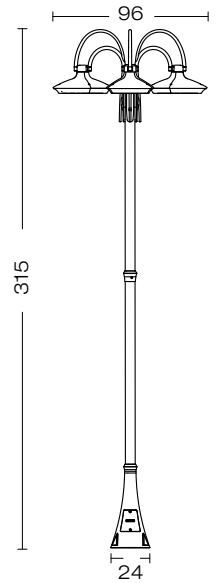

180L24.P3
L24H.P3

For technical details visit
www.landa.it

IP65



96°

COLOURS



ngg



nga



ngv



nhg



ngr

BASE DIMENSIONS

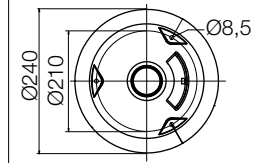

ELECTRIFICATION

LED

dettagli /
details / details
detalles / details:
pages 4-5

L24
LED 24 W
5000°K
2880LM
Ra65



L24H
LED 24 W
3000°K
1900LM
Ra85



morphis



LED

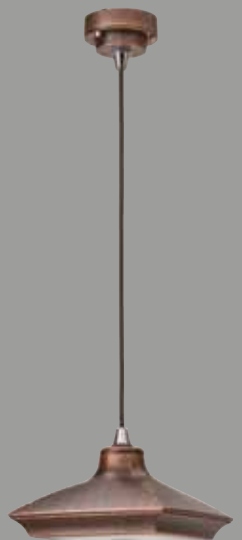

Accessories on request:



code 0404M004
Single connection IP68



code 0404M003
Loop in loop out IP68

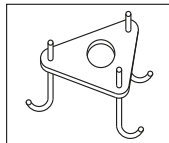

code 00A170.01P
Anchor Bolt

art.
170

designers Innocenzo Rifino
& Lorenzo Ruggieri

OHIM:
patent No.
001099873-0001

Beijing - China
HC-IP Agency Co., LTD
patent No.
200930194044.2

corpo alluminio pressofuso
body in die casting aluminium
corps en aluminium moulé
sous pression
cuerpo aluminio inyectado
Körper aus Aluminium-
Druckguss

diffusore policarbonato
trasparente
diffuser transparent
polycarbonate
diffuser polycarbonate
transparent
difusor policarbonato
transparente
Diffuser Polykarbonat klar

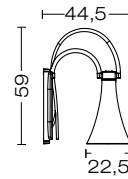
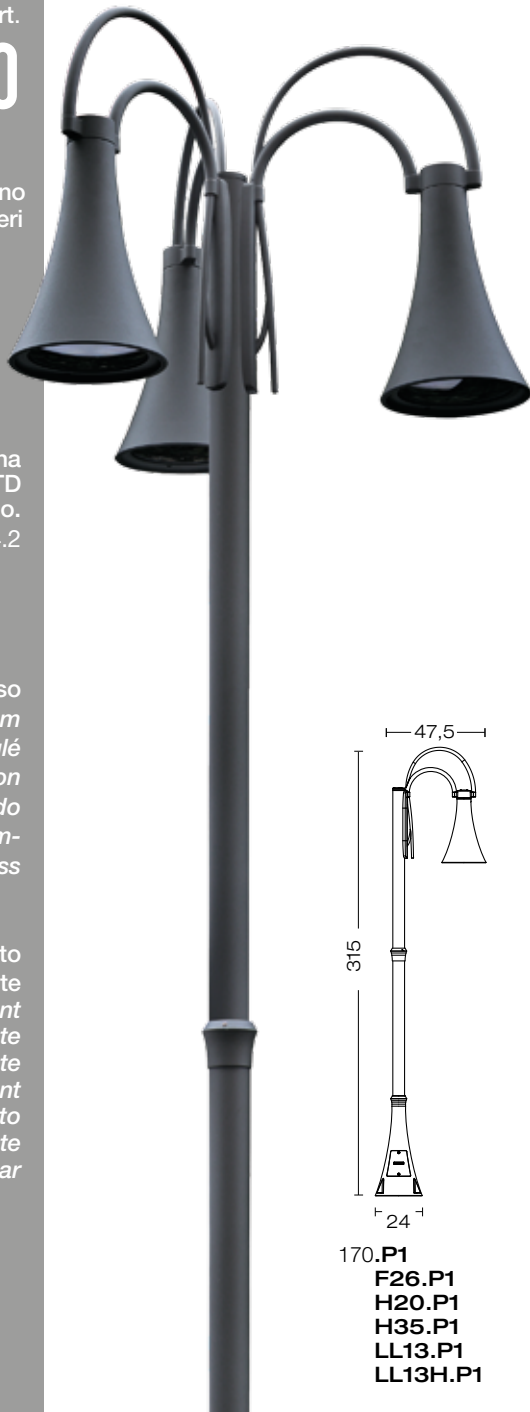

170.01
F26.01
H20.01
H35.01
LL13.01
LL13H.01



170.02
F26.02
H20.02
H35.02
LL13.02
LL13H.02

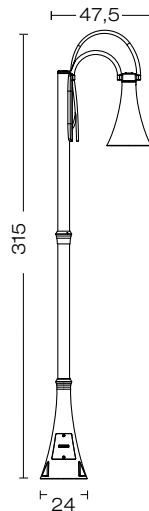

170.P1
F26.P1
H20.P1
H35.P1
LL13.P1
LL13H.P1

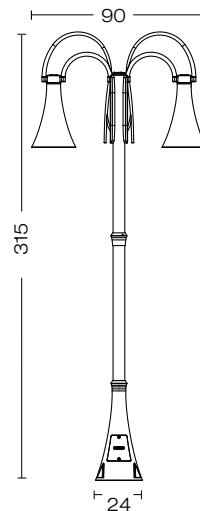

170.P2
F26.P2
H20.P2
H35.P2
LL13.P2
LL13H.P2

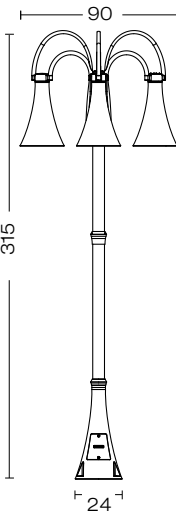

170.P3
F26.P3
H20.P3
H35.P3
LL13.P3
LL13H.P3

For technical details visit
www.landa.it

IP65



960°

COLOURS

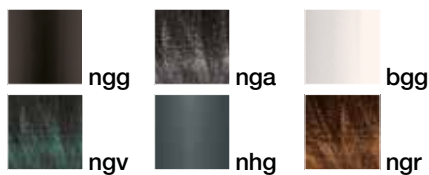

BASE DIMENSIONS

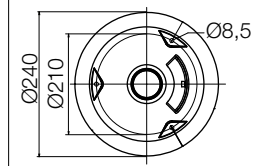

ELECTRIFICATION
LED
dettagli /
details / details
detalles / details:
pages 4-5

LL13
LED 13 W
5000°K
1330LM
Ra65

LL13H
LED 13 W
2900°K
900LM
Ra85

E27
MAX 23 W

170.01
.02
.P1
.P2
.P3

F26
26 W
Gx24 q-3

H20
20 W
PGJ5

H35
35 W
G8,5



LED



Accessories on request:



code **0404M004**
Single connection IP68



code **0404M003**
Loop in loop out IP68

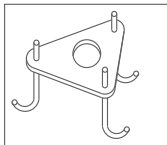

Anchor Bolt
code **00A170.01P**

art.
470

designers Innocenzo Rifino
 & Lorenzo Ruggieri

progetto Meta-Distrettuale Numa

OHIM:
 patent No.
 N° 000346366-0002

Beijing - China
 HC-IP Agency Co., LTD
 patent pending



Una lampada, due soluzioni, un prezzo / One light, two solutions, one price
 Une lumière, deux solutions, un prix / Una luz, dos soluciones, un precio
 Eine Leuchte, zwei Lösungen, ein Preis

corpo alluminio pressofuso e
 estruso
*body in die casting and
 extruded aluminium*
*corps en aluminium moulé
 sous pression et extrudé*
*cuerpo aluminio inyectado y
 extrusionado*
*Körper aus Aluminium-
 Druckguss*

diffusore policarbonato opale
diffuser opal polycarbonate
diffuser polycarbonate opale
difusor policarbonato ópalo
Diffuser Polykarbonat opal

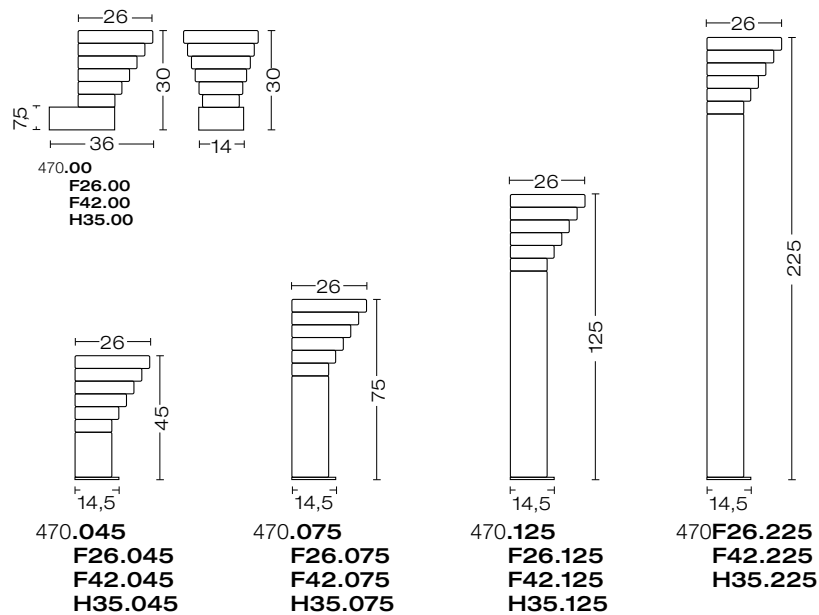

For technical details visit
www.landa.it

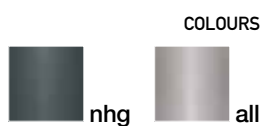

ELECTRIFICATION

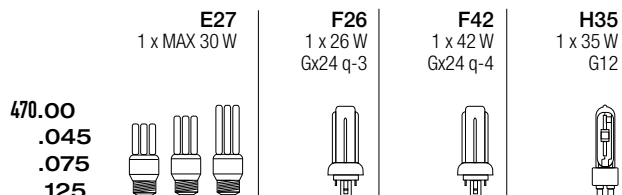



Accessories on request:



code **0404M004**
Single connection IP68



code **0404M003**
Loop in loop out IP68

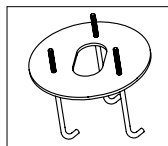

code **00A470**
Anchor Bolt

art.	electrification	finishing	size	colour
450	F18	.	00	nhg

art.	electrification	finishing	size	colour
450	F18	K	00	nhg

art.

450

design aDD & Leon & Monte

progetto Meta-Distrettuale Numa

OHIM:
patent No.
000346366-0001

Beijing - China
HC-IP Agency Co., LTD
patent pending

corpo alluminio pressofuso
e estruso
*body in die casting
and extruded aluminium*
*corps en aluminium moulé
sous pression et extrudé*
*cuerpo aluminio inyectado
y extrusionado*
*Körper aus Aluminium-
Druckguss*

diffusore policarbonato
trasparente
diffuser transparent
polycarbonate
diffuser polycarbonate
transparent
difusor policarbonato
transparente
Diffuser Polykarbonat klar

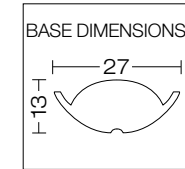
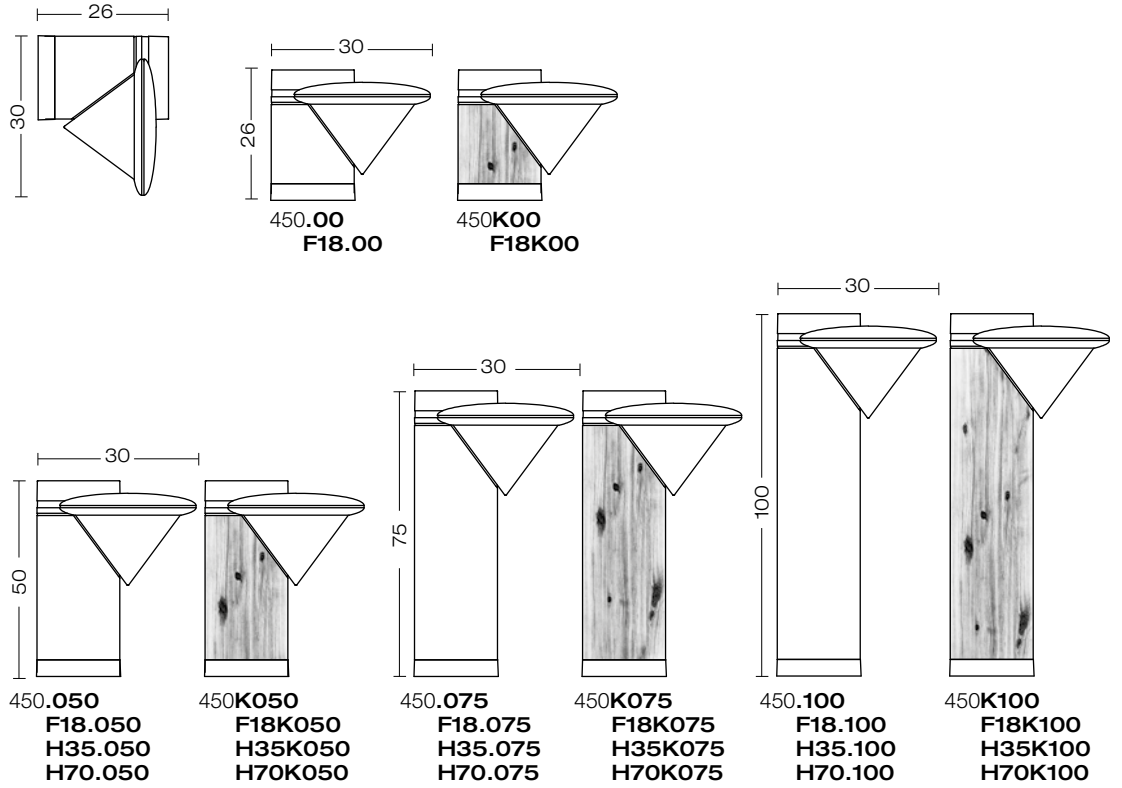

Electrification and Anchor Bolt for:

- 450H35.050
- 450H35.075
- 450H35.100
- 450H70.050
- 450H70.075
- 450H70.100

- 450H35K050
- 450H35K075
- 450H35K100
- 450H70K050
- 450H70K075
- 450H70K100

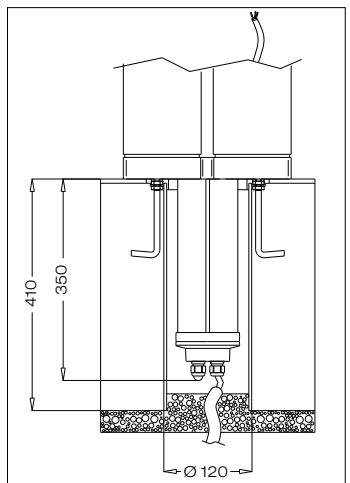

For technical details visit
www.landa.it



FINISHING

K
dettagli / details
details / detalles
page 10
code 450K....

Wood that isn't wood

Processo produttivo non inquinante
Production process is not polluting
C'est un procédé productif non polluant
Proceso productivo no contaminante
Chemierückstand und Abwasser

COLOURS

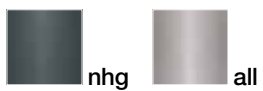

ELECTRIFICATION

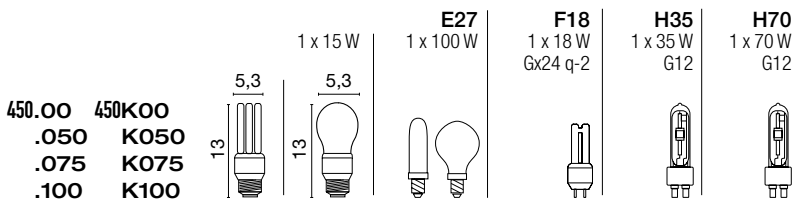



Accessories on request:

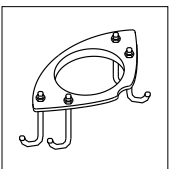

Anchor Bolt
code **00A450**

art.

406

designers Teseo Berghella

OHIM:
patent No.
001810037-002

Beijing - China
HC-IP Agency Co., LTD
patent pending



406.L6
406.L6H

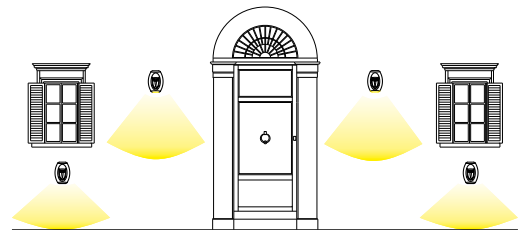
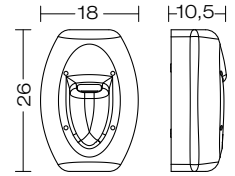

corpo alluminio EN47000
body EN47000 aluminium
corps EN47000 aluminium
cuerpo aluminio EN47000
Körper EN47000 Aluminium

diffusore policarbonato frosted
diffuser frosted polycarbonate
diffuser polycarbonate frosted
difusor policarbonato frosted
Diffuser Polykarbonat frosted

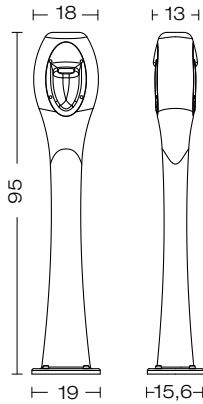

406.095L6
.095L6H
.095L12
.095L12H
.095LS12
.095LS12H



406.095L6
406.095L6H



406.095LS12
406.095LS12H



406.095L12
406.095L12H

For technical details visit
www.landa.it

IP65



COLOURS

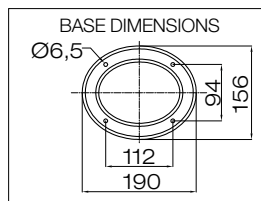

Included:



code 0404M004
Single connection IP68

ELECTRIFICATION
LED
dettagli /
details / details
detalles / details:
pages 4-5

L6
LED 6 W
5000°K
720LM
Ra65

L6H
LED 6 W
3000°K
475LM
Ra85

L12
LS12
LED 12 W
5000°K
1440LM
Ra65

L12H
LS12H
LED 12 W
3000°K
950LM
Ra85

oko



LED



Accessories on request:



code **0404M003**
Loop in loop out IP68

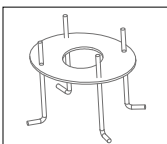

code **00A406.01P**
Anchor Bolt

serie/series

oko

NEW

example code:

| art. | size | electrification | colour |
406 .095 F26 nhg

art.

406

designers Teseo Berghella

OHIM:
patent No.
001810037-002

Beijing - China
HC-IP Agency Co., LTD
patent pending



406
406.F18

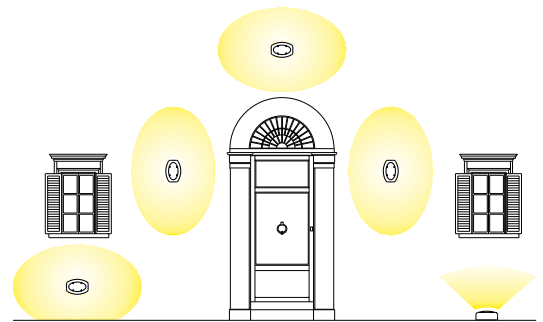
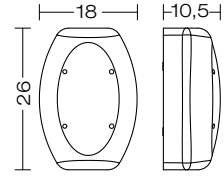

corpo alluminio EN47000
body EN47000 aluminium
corps EN47000 aluminium
cuerpo aluminio EN47000
Körper EN47000 Aluminium

diffusore policarbonato frosted
diffuser frosted polycarbonate
diffuser polycarbonate frosted
difusor policarbonato frosted
Diffuser Polykarbonat frosted

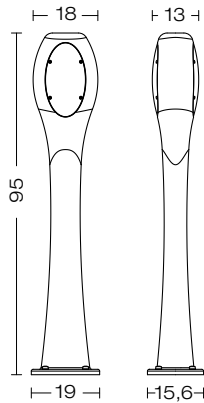

406.095
.095F26
.095H35



406.095
406.095F26
406.095H35



Incluso: accessorio per monodirezione
Included: monodirectional accessory
Inclus: accessoire monodirectionnel
Incluido: accesorio monodirecional
Beiliegend: unidirektionale Zuberhör

For technical details visit
www.landa.it

IP65



960°

COLOURS

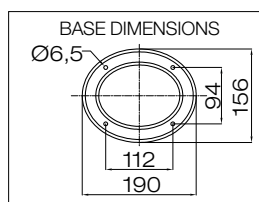

Included:



code O404M004
Single connection IP68

ELECTRIFICATION

E27
MAX 27 W

F26
26 W
Gx24 q-3

H35
35 W
G8.5

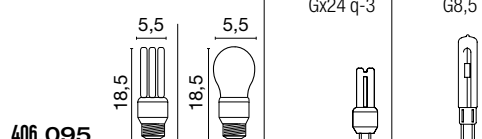

406.095

oko



Accessories on request:



code **0404M003**
Loop in loop out IP68

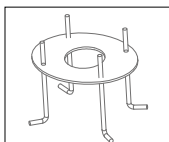

code **00A406.01P**
Anchor Bolt

art.
405

designers **Innocenzo Rifino & Lorenzo Ruggieri**

OHIM:
patent No.
000659917-0003

Beijing - China
HC-IP Agency Co., LTD
patent pending

corpo alluminio pressofuso
e estruso
*body in die casting
and extruded aluminium*
*corps en aluminium moulé
sous pression et extrudé*
*cuerpo aluminio inyectado
y extrusionado*
*Körper aus Aluminium-
Druckguss*

diffusore policarbonato
trasparente
diffuser transparent
polycarbonate
diffuser polycarbonate
transparent
difusor policarbonato
transparente
Diffuser Polykarbonat klar

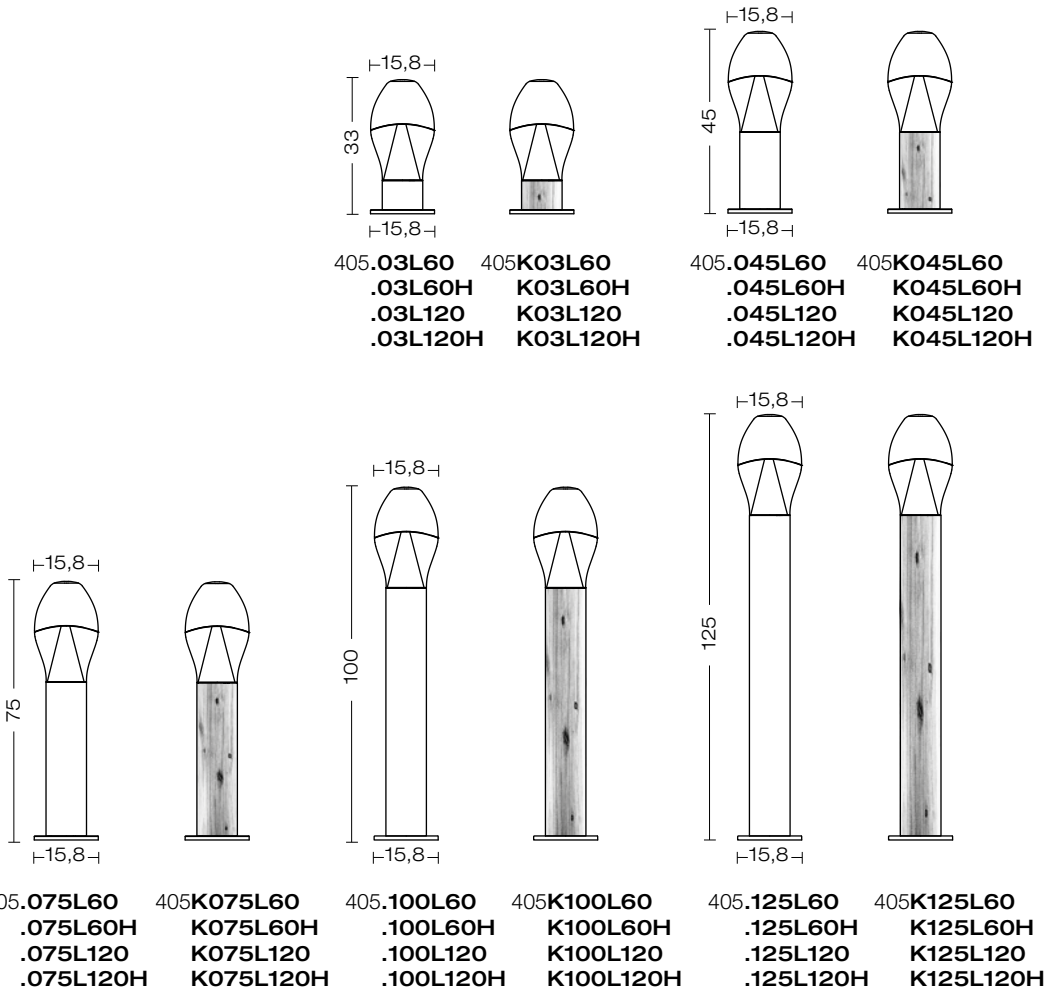

For technical details visit
www.landa.it



FINISHING

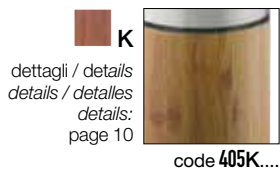

Wood that isn't wood

Processo produttivo non inquinante
Production process is not polluting
C'est un procédé productif non polluant
Proceso productivo no contaminante
Chemierückstand und Abwasser

COLOURS

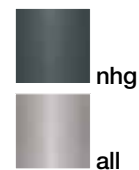

Included:



code **0404M004**
Single connection IP68

ELECTRIFICATION
LED
dettagli /
details / details
détalles / details:
pages 4-5

L60 LED 5 W 5000°K 430LM Ra65	L60H LED 5 W 2900°K 330LM Ra85	L120 LED 10 W 5000°K 910LM Ra65	L120H LED 10 W 2900°K 680LM Ra85
○	○	○	○



LED



Accessories on request:



code 0404M003
Loop in loop out IP68

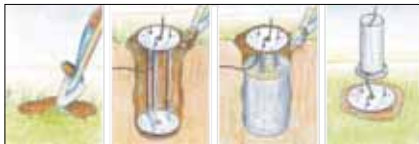

Root Mounting Kit code 00A405

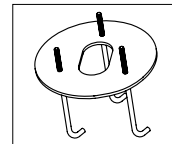
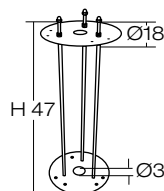

code 00A405.01P
Anchor Bolt

example code:

art.	finishing	size	electrification	colour
405	.	100	F18	all
COUNTRY example code:				
art.	finishing	size	electrification	colour
405	K	100	F18	nhg

art.
405

designers **Innocenzo Rifino & Lorenzo Ruggieri**

OHIM:
patent No.
000659917-0003

Beijing - China
HC-IP Agency Co., LTD
patent pending

corpo alluminio pressofuso
e estruso
*body in die casting
and extruded aluminium*
*corps en aluminium moulé
sous pression et extrudé*
*cuerpo aluminio inyectado
y extrusionado*
*Körper aus Aluminium-
Druckguss*

diffusore policarbonato
trasparente
diffuser transparent
polycarbonate
diffuser polycarbonate
transparent
difusor policarbonato
transparente
Diffuser Polykarbonat klar

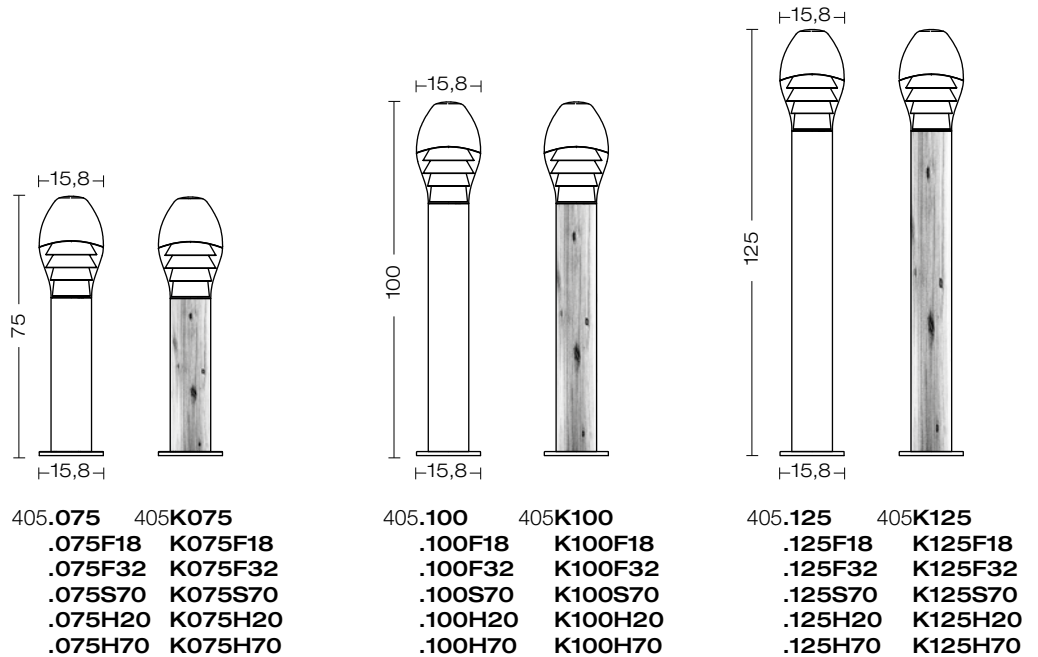
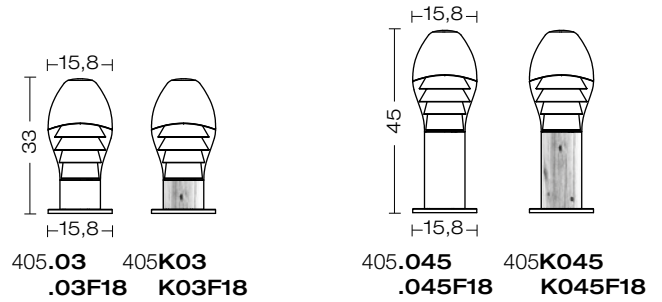

For technical details visit
www.landa.it



FINISHING

K
dettagli / details
detales / details:
details:
page 10



Wood that isn't wood

Processo produttivo non inquinante
Production process is not polluting
C'est un procédé productif non polluant
Proceso productivo no contaminante
Chemierückstand und Abwasser

COLOURS

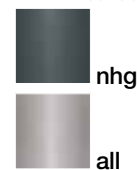

Included:



ELECTRIFICATION

	1 x MAX 75 W	1 x 23 W	E27 1 x 16 W	F18 1 x 18 W Gx24 q-2	F32 1 x 32 W Gx24 q-3	H20 1 x 20 W PGJ5	S70 1 x 70 W E27 sodium	H70 1 x 70 W G12 metal halide
450.03	450K03	5,3	5,3					
.045	K045	16,5	16,5					
.075	K075							
.100	K100							
.125	K125							



Accessories on request:



code **0404M003**
Loop in loop out IP68

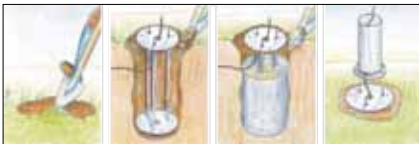

Root Mounting Kit code **00A405**

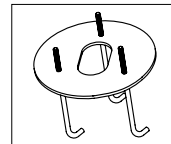
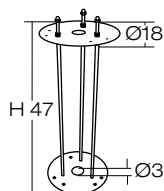

code **00A405.01P**
Anchor Bolt

example code:

art.	finishing	size	electrification	colour
403	.	090	F18	all
COUNTRY example code:				
403	K	090	F18	all

art.

403 4031

design Ufficio Tecnico Landa

OHIM:
patent No.
000508106-0002

corpo alluminio pressofuso
e estruso
*body in die casting
and extruded aluminium*
*corps en aluminium moulé
sous pression et extrudé*
*cuerpo aluminio inyectado
y extrusionado*
*Körper aus Aluminium-
Druckguss*

diffusore policarbonato
trasparente
diffuser transparent
polycarbonate
diffuser polycarbonate
transparent
difusor policarbonato
transparente
Diffuser Polykarbonat klar

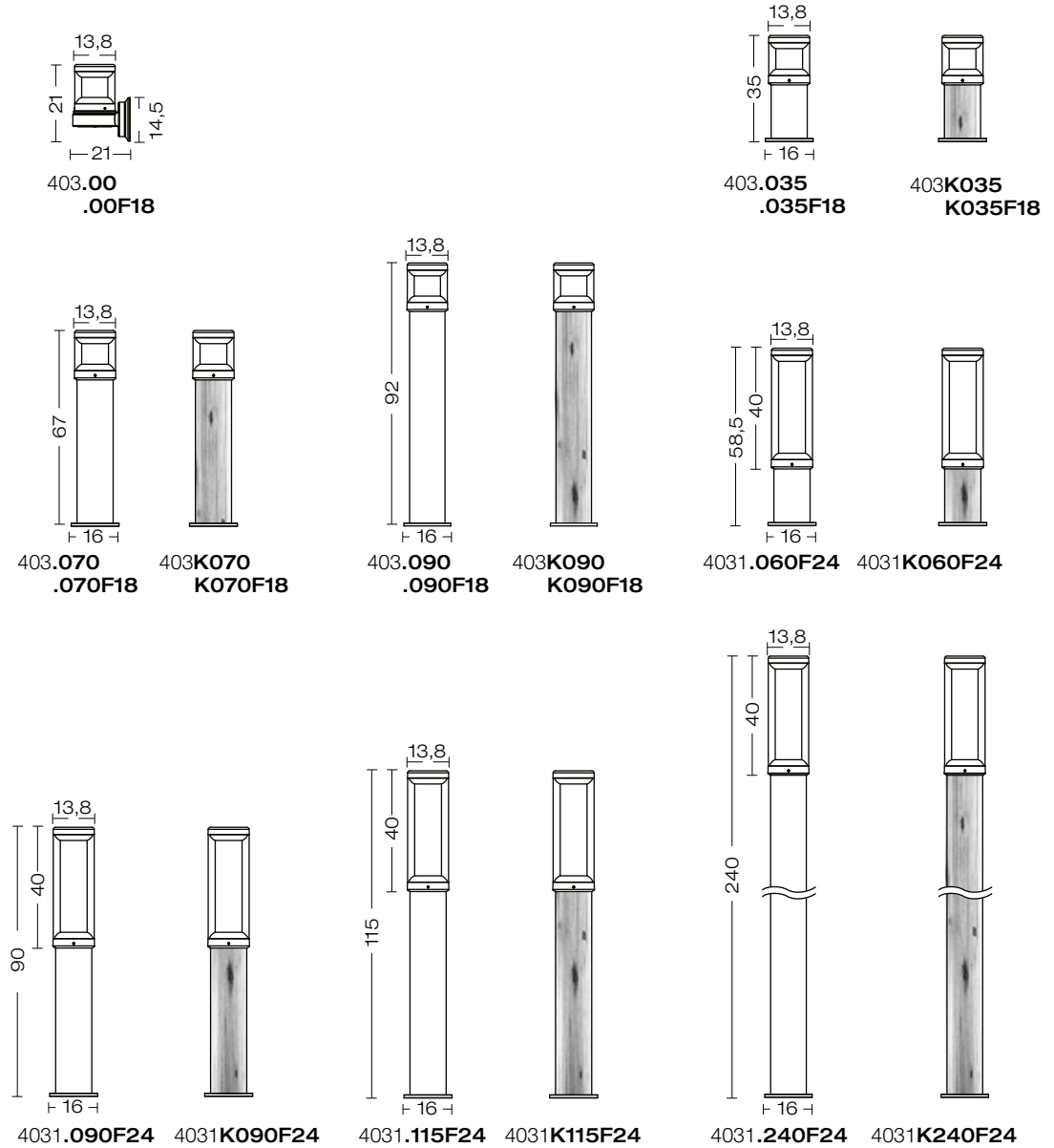

For technical details visit
www.landa.it



code 403.00 – 403.00F18 IP44

FINISHING

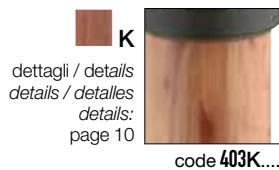

Wood that isn't wood

Processo produttivo non inquinante
Production process is not polluting
C'est un procédé productif non polluant
Proceso productivo no contaminante
Chemierückstand und Abwasser

COLOURS



ELECTRIFICATION

Model	Electrification	Power	Socket
403.00	E27	1 x 23 W	Edison
403K00	E27	1 x 23 W	Edison
.035	F18	1 x 18 W	Gx24 q-2
K035	F18	1 x 18 W	Gx24 q-2
.070	F24	1 x 24 W	2G11
K070	F24	1 x 24 W	2G11
.090	F24	1 x 24 W	2G11
K090	F24	1 x 24 W	2G11



Accessories on request:



code 0404M004
Single connection IP68



code 0404M003
Loop in loop out IP68

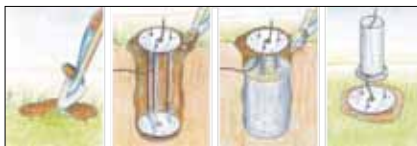

Root Mounting Kit code 00A405

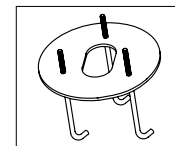
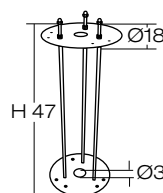

code 00A405.01P
Anchor Bolt

art.	finishing	size	LED	○	colour
403	.	090	L120	H	nhg
COUNTRY example code:					
art.	finishing	size	LED	○	colour
403	K	090	L120	H	nhg

art.
403
4031

design Ufficio Tecnico Landa

OHIM:
patent No.
000508106-0002

corpo alluminio pressofuso
e estruso
*body in die casting
and extruded aluminium*
*corps en aluminium moulé
sous pression et extrudé*
*cuerpo aluminio inyectado
y extrusionado*
*Körper aus Aluminium-
Druckguss*

diffusore policarbonato
trasparente
diffuser transparent
polycarbonate
diffuser polycarbonate
transparent
difusor policarbonato
transparente
Diffuser Polykarbonat klar

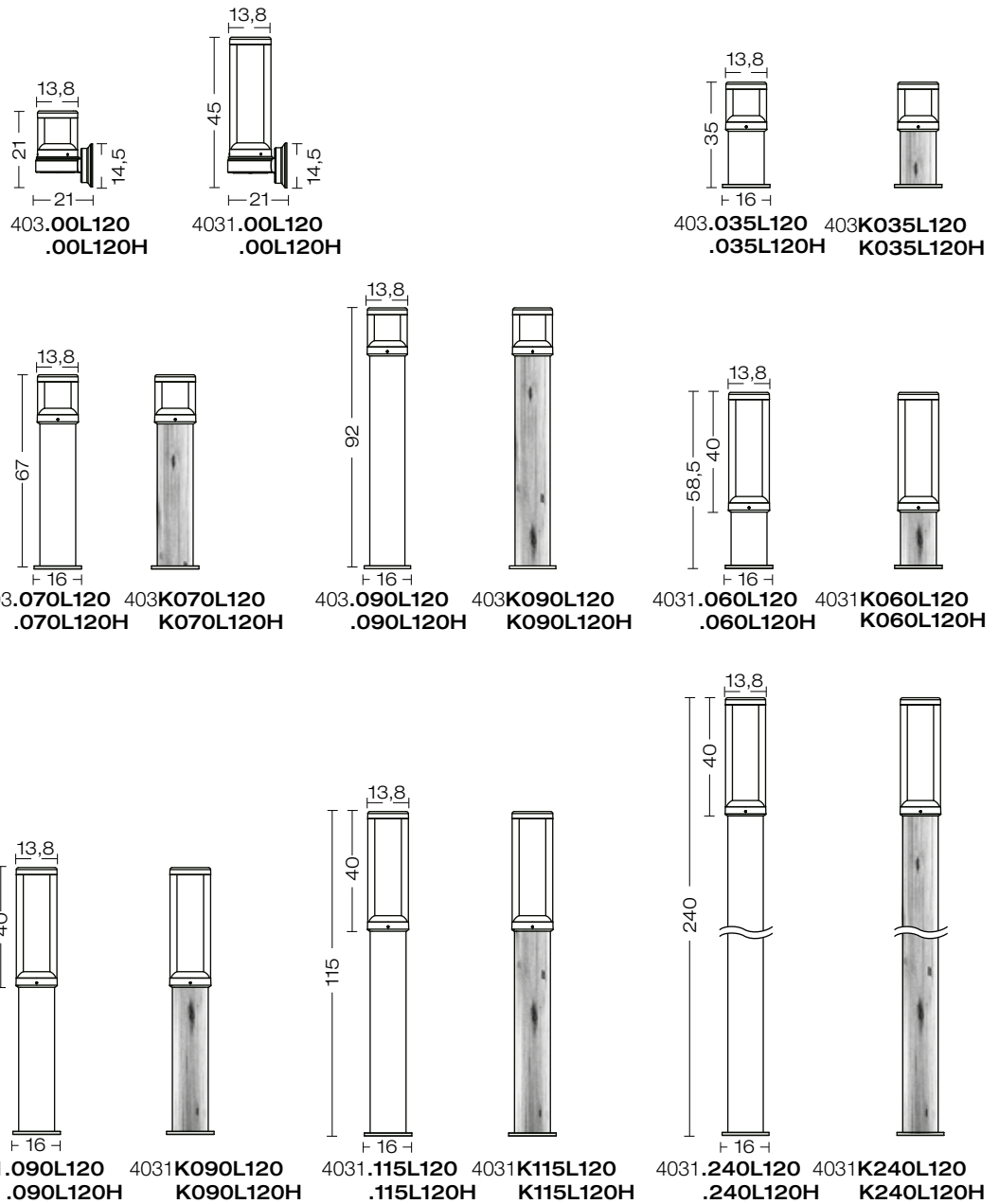

For technical details visit
www.landa.it



code 403.00... - 4031.00... IP44

FINISHING

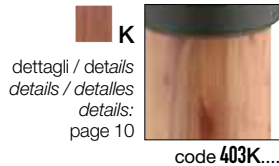

Wood that isn't wood

Processo produttivo non inquinante
Production process is not polluting
C'est un procédé productif non polluant
Proceso productivo no contaminante
Chemierückstand und Abwasser

COLOURS



ELECTRIFICATION



dettagli /
details / details
detalles / details:
pages 4-5

L120
LED 10 W
5000°K
910LM
Ra65



L120H
LED 10 W
2900°K
680LM
Ra85





LED



Accessories on request:



code 0404M004
Single connection IP68



code 0404M003
Loop in loop out IP68

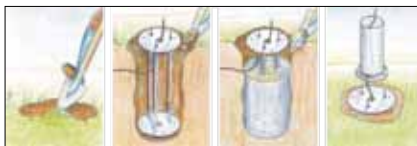

Root Mounting Kit code 00A405

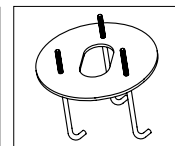
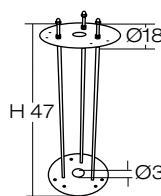

code 00A405.01P
Anchor Bolt

example code:

art.	finishing	size	electrification	colour
402	.	090	F18	nhg
COUNTRY example code:				
402	K	090	F18	nhg

art.

402 4021

design Ufficio Tecnico Landa

OHIM:
patent No.
000508106-0002

corpo alluminio pressofuso
e estruso
*body in die casting
and extruded aluminium*
*corps en aluminium moulé
sous pression et extrudé*
*cuerpo aluminio inyectado
y extrusionado*
*Körper aus Aluminium-
Druckguss*

diffusore policarbonato
trasparente
diffuser transparent
polycarbonate
diffuser polycarbonate
transparent
difusor policarbonato
transparente
Diffuser Polykarbonat klar

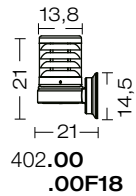

402.00
.00F18

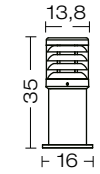

402.035
.035F18
.035H20
.035H35

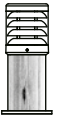

402K035
K035F18
K035H20
K035H35



402.070
.070F18
.070H20
.070H35

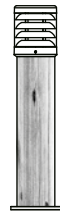

402K070
K070F18
K070H20
K070H35

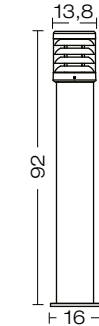

402.090
.090F18
.090H20
.090H35



402K090
K090F18
K090H20
K090H35

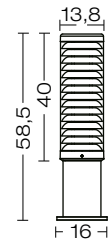

4021.060F24

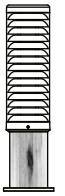

4021K060F24

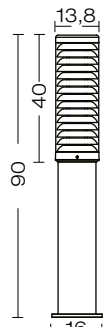

4021.090F24



4021K090F24

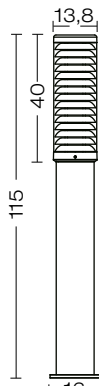

4021.115F24



4021K115F24

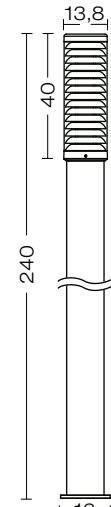

4021.240F24

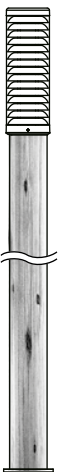

4021K240F24

For technical details visit
www.landa.it



code 402.00 – 402.00F18 IP44

FINISHING

K
dettagli / details
details / detalles
details:
page 10



code 402K....

Wood that isn't wood

Processo produttivo non inquinante
Production process is not polluting
C'est un procédé productif non polluant
Proceso productivo no contaminante
Chemierückstand und Abwasser

COLOURS



nhg



all

ELECTRIFICATION

402.00	402K00	E27	F18	F24	H20	H35
.035	K035	MAX 23 W	1 x 18 W	1 x 24 W	20 W	35 W
.070	K070		Gx24 q-2	2G11	PGJ5	G12
.090	K090					



Accessories on request:



code 0404M004
Single connection IP68



code 0404M003
Loop in loop out IP68

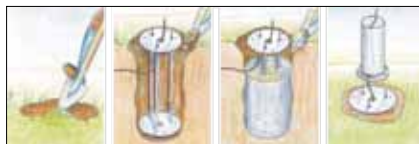

Root Mounting Kit code 00A405

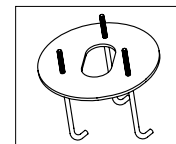
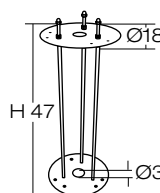

code 00A405.01P
Anchor Bolt

example code:

art.	electrification	finishing	size	colour
440	PL9	.	040 P1	nhg

COUNTRY example code:

art.	electrification	finishing	size	colour
440	PL9	K	040 P1	nhg

art.

440

design Duse & Righetto

progetto Meta-Distrettuale Numa

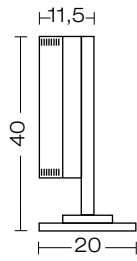
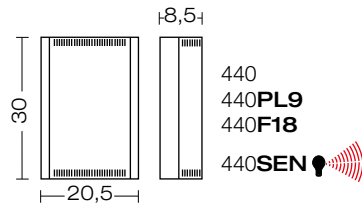

440.040P1
PL9.040P1
F18.040P1
.040P1SEN

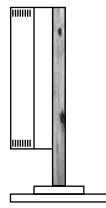

440K040P1
PL9K040P1
F18K040P1
K040P1SEN

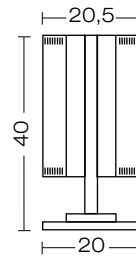

440.040P2
PL9.040P2
F18.040P2
.040P2SEN

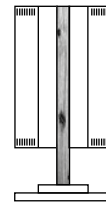

440K040P2
PL9K040P2
F18K040P2
K040P2SEN

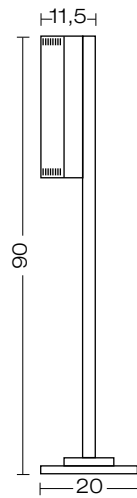

440.090P1
PL9.090P1
F18.090P1
.090P1SEN



440K090P1
PL9K090P1
F18K090P1
K090P1SEN

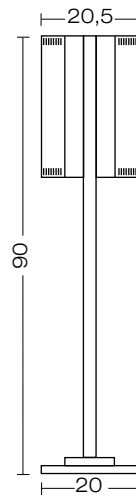

440.090P2
PL9.090P2
F18.090P2
.090P2SEN



440K090P2
PL9K090P2
F18K090P2
K090P2SEN

corpo alluminio pressofuso
e estruso
*body in die casting
and extruded aluminium*
*corps en aluminium moulé
sous pression et extrudé*
*cuero aluminio inyectado
y extrusionado*
*Körper aus Aluminium-
Druckguss*

diffusore policarbonato opale
diffuser polycarbonate opal
diffuser polycarbonate opale
difusor policarbonato ópalo
Diffuser Polykarbonat opal

For technical details visit
www.landa.it



FINISHING

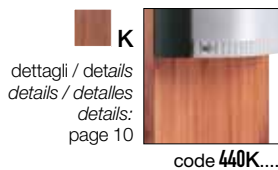

Wood that isn't wood

Processo produttivo non inquinante
Production process is not polluting
C'est un procédé productif non polluant
Proceso productivo no contaminante
Chemierückstand und Abwasser

COLOURS

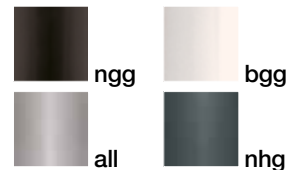

ELECTRIFICATION

sensor



1 x
440
440SEN
440...P1
440...P1SEN
2 x
440...P2
440...P2SEN
page 7

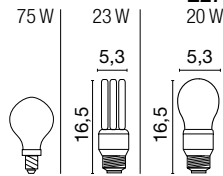

2 x 9 W
440PL9
440PL9...P1
4 x 9 W
440PL9...P2



2 x 18 W
440F18
440F18...P1
4 x 18 W
440F18...P2





art.
822

design Ufficio Tecnico Landa

OHIM:
patent No.
000508106-0002

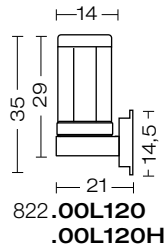

822.**.00L120**
.00L120H

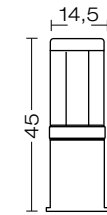

822.**.045L120**
.045L120H

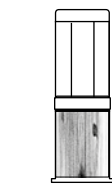

822.**K045L120**
K045L120H

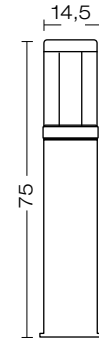

822.**.075L120**
.075L120H



822.**K075L120**
K075L120H

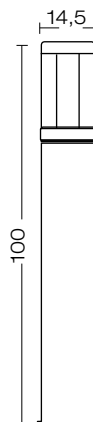

822.**.100L120**
.100L120H



822.**K100L120**
K100L120H

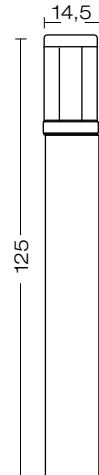

822.**.125L120**
.125L120H



822.**K125L120**
K125L120H

corpo acciaio inox AISI 316L
body stainless steel AISI 316L
corps acier inoxydable AISI 316L
cuerpo acero inox AISI 316L
Körper Edelstahl AISI 316L

diffusore policarbonato
trasparente
diffuser transparent
polycarbonate
diffuser polycarbonate
transparent
difusor policarbonato
transparente
Diffuser Polykarbonat klar



stainless steel CLEANER
code OODEC
details: page 191

For technical details visit
www.landa.it



FINISHING

K
dettagli / details
details / detalles
details:
page 10



code **822K**....

Wood that isn't wood

Processo produttivo non inquinante
Production process is not polluting
C'est un procédé productif non polluant
Proceso productivo no contaminante
Chemierückstand und Abwasser



code **822**.....

ELECTRIFICATION
LED
dettagli /
details / details
detales / details:
pages 4-5

L120 LED 10 W 5000°K 910LM Ra65	L120H LED 10 W 2900°K 680LM Ra85
--	---





LED

NEW
AISI 316L



Accessories on request:

Accessories not available for: 822.00....



code **0404M004**
Single connection IP68



code **0404M003**
Loop in loop out IP68

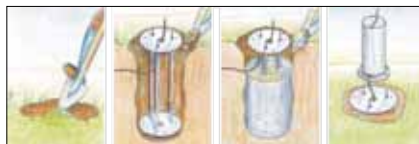

Root Mounting Kit code **00A400**

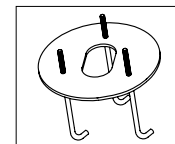
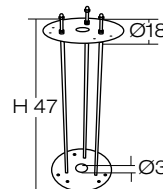

code **00A400.01P**
Anchor Bolt

art.	finishing	size	electrification
822	K	100	F42

art.	finishing	size	electrification
822	K	100	F42

art.
822

design Ufficio Tecnico Landa

OHIM:
patent No.
000508106-0002

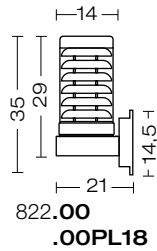

822.00
.00PL18

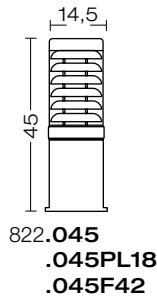

822.045
.045PL18
.045F42

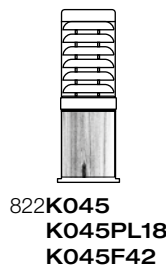

822K045
K045PL18
K045F42

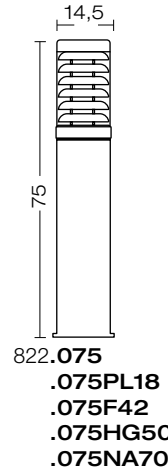

822.075
.075PL18
.075F42
.075HG50
.075NA70

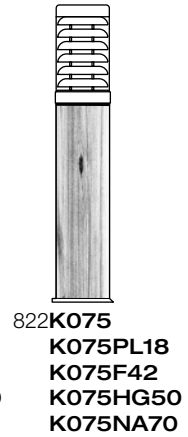

822K075
K075PL18
K075F42
K075HG50
K075NA70

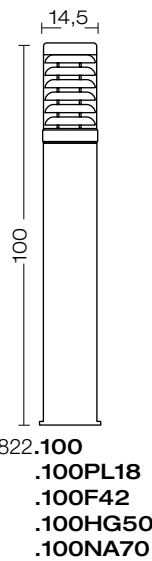

822.100
.100PL18
.100F42
.100HG50
.100NA70

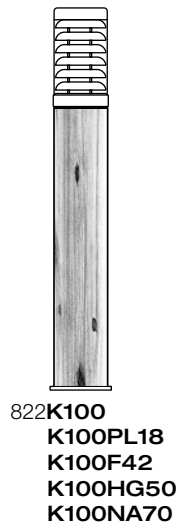

822K100
K100PL18
K100F42
K100HG50
K100NA70

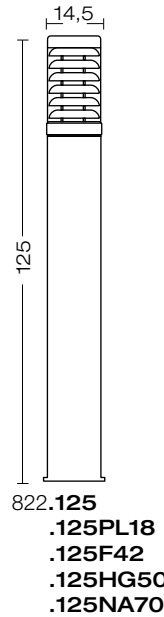

822.125
.125PL18
.125F42
.125HG50
.125NA70

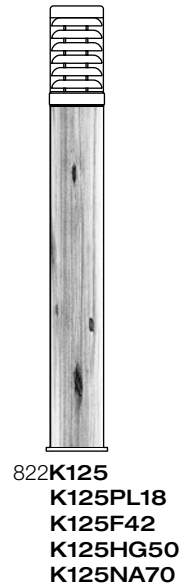

822K125
K125PL18
K125F42
K125HG50
K125NA70

corpo acciaio inox AISI 316L
body stainless steel AISI 316L
corps acier inoxydable AISI 316L
cuerpo acero inox AISI 316L
Körper Edelstahl AISI 316L

diffusore policarbonato
trasparente
diffuser transparent
polycarbonate
diffuser polycarbonate
transparent
difusor policarbonato
transparente
Diffuser Polykarbonat klar



stainless steel CLEANER
code OODEC
details: page 191

For technical details visit
www.landa.it



FINISHING

K
dettagli / details
details / detalles
details:
page 10



code 822K....

Wood that isn't wood

Processo produttivo non inquinante
Production process is not polluting
C'est un procédé productif non polluant
Proceso productivo no contaminante
Chemierückstand und Abwasser



code 822.....

ELECTRIFICATION

822.00	1x75 W	1x30 W	E27 1x30W	PL18 1x18 W G24 q-2	822.045	PL18	F42	HG50	NA70
					.075	1x18 W G24 d-2	1x42 W Gx24 q-4	1x50 W E27 mercury	1x70 W E27 metal halide
.100					822K045				
.125					K075				
					K100				
					K125				



NEW
AISI 316L



Accessories on request:

Accessories not available for: 822.00 – 822.00PL18



code 0404M004
Single connection IP68



code 0404M003
Loop in loop out IP68

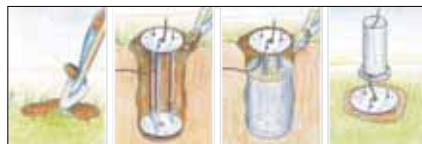

Root Mounting Kit code 00A400

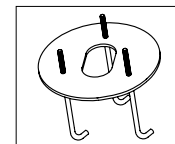
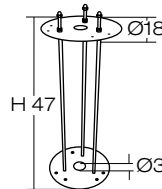

code 00A400.01P
Anchor Bolt

art.

820

design Ufficio Tecnico Landa

OHIM:
patent No.
000508106-0002

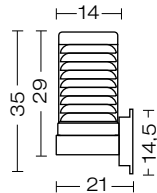

820.00
.00PL18

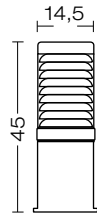

820.045
.045PL18
.045F42

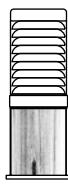

820K045
K045PL18
K045F42

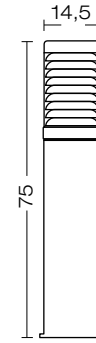

820.075
.075PL18
.075F42
.075HG50
.075NA70

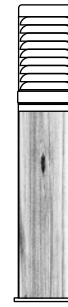

820K075
K075PL18
K075F42
K075HG50
K075NA70



820.100
.100PL18
.100F42
.100HG50
.100NA70



820K100
K100PL18
K100F42
K100HG50
K100NA70

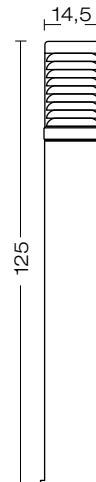

820.125
.125PL18
.125F42
.125HG50
.125NA70



820K125
K125PL18
K125F42
K125HG50
K125NA70

corpo acciaio inox AISI 316L
body stainless steel AISI 316L
corps acier inoxydable AISI 316L
cuerpo acero inox AISI 316L
Körper Edelstahl AISI 316L

diffusore policarbonato
trasparente
diffuser transparent
polycarbonate
diffuser polycarbonate
transparent
difusor policarbonato
transparente
Diffuser Polykarbonat klar



stainless steel CLEANER
code OODEC
details: page 191

For technical details visit
www.landa.it



FINISHING

K
dettagli / details
details / detalles
details:
page 10



code 820K....

Wood that isn't wood

Processo produttivo non inquinante
Production process is not polluting
C'est un procédé productif non polluant
Proceso productivo no contaminante
Chemierückstand und Abwasser



code 820.....

ELECTRIFICATION

Code	Power	Base	Beam Angle	Image
820.00	1x75 W	E27	1x30 W	
.045	1x30 W	E27	5,8	
.075	1x30 W	E27	5,8	
.100	1x18 W	PL18	G24 q-2	
.125	1x18 W	PL18	G24 d-2	
820K045	1x42 W	F42	Gx24 q-4	
K075	1x50 W	HG50	E27	
K100	1x70 W	NA70	metal halide	
K125	1x70 W	NA70	metal halide	



Accessories on request:

Accessories not available for: 820.00 – 820.00PL18



code 0404M004
Single connection IP68



code 0404M003
Loop in loop out IP68

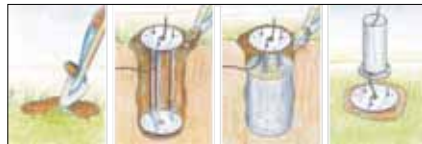

Root Mounting Kit code 00A400

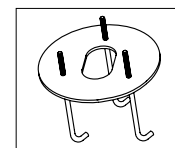
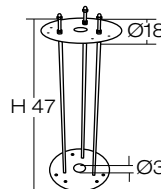

code 00A400.01P
Anchor Bolt

example code:

art.	finishing	size	electrification	colour
400	K	100	PL18	nhg

COUNTRY example code:

art.	finishing	size	electrification	colour
400	K	100	PL18	nhg

art.
400

design Ufficio Tecnico Landa

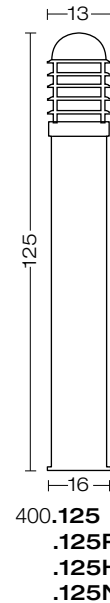
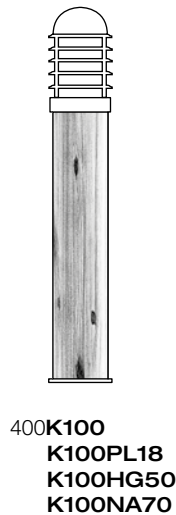
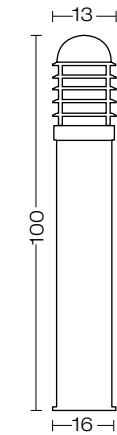
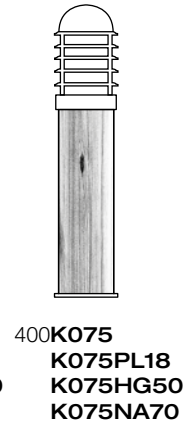
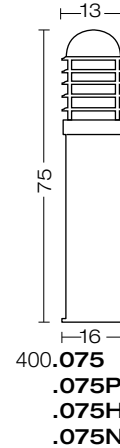
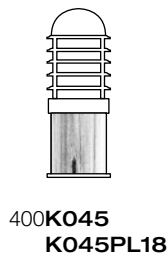
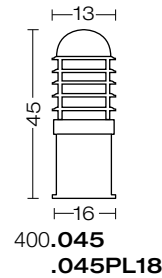
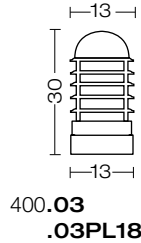
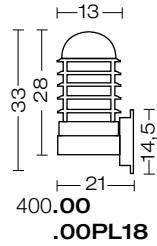

corpo alluminio pressofuso
e estruso
*body in die casting
and extruded aluminium*
corps en aluminium moulé
sous pression et extrudé
cuerpo aluminio inyectado
y extrusionado
Körper aus Aluminium-
Druckguss

diffusore policarbonato opale
diffuser polycarbonate opal
diffuser polycarbonate opale
difusor policarbonato ópalo
Diffuser Polykarbonat opal

For technical details visit
www.landa.it

IP44

850°

FINISHING

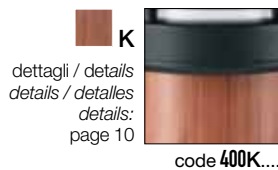

Wood that isn't wood

Processo produttivo non inquinante
Production process is not polluting
C'est un procédé productif non polluant
Proceso productivo no contaminante
Chemierückstand und Abwasser

COLOURS

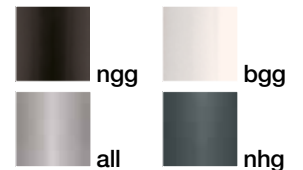

ELECTRIFICATION

400.00 .03	1 x 75 W								
400.045 .075 .100 .125	1 x 100 W	400K045 K075 K100 K125	1 x 23 W	5.3	1 x 20 W	5.3	PL18 1 x 18 W Gx24 q-2	400.045 .075 .100 .125	PL18 1 x 18 W G24 d-2
								400K045 K075 K100 K125	HG50 1 x 50 W E27 mercury
									NA70 1 x 70 W E27 metal halide and sodium

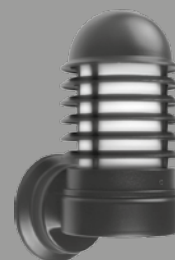

Accessories on request:

Accessories not available for: 400.00 – 400.00PL18 – 400.03 – 400.03PL18



code 0404M004
Single connection IP68



code 0404M003
Loop in loop out IP68

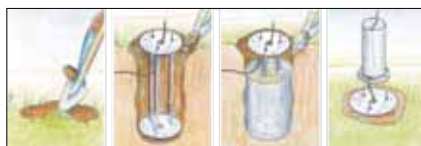

Root Mounting Kit code 00A400

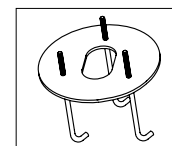
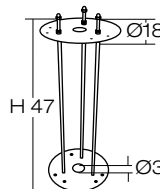

code 00A400.01P
Anchor Bolt

art.	finishing	size	electrification	colour
401	K	075	NA70	nhg

art.	finishing	size	electrification	colour
401	K	075	NA70	nhg

art.
401

design Ufficio Tecnico Landa

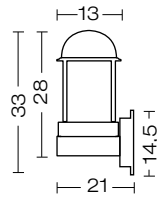

401.00
.00PL18

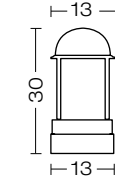

401.03
.03PL18

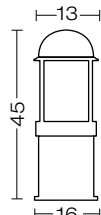

401.045
.045PL18



401K045
K045PL18

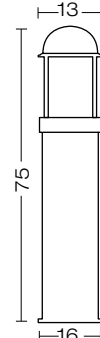

401.075
.075PL18
.075HG50
.075NA70



401K075
K075PL18
K075HG50
K075NA70

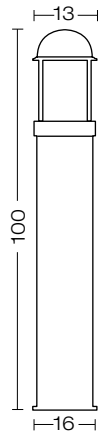

401.100
.100PL18
.100HG50
.100NA70



401K100
K100PL18
K100HG50
K100NA70

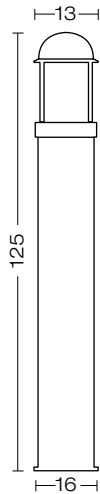

401.125
.125PL18
.125HG50
.125NA70



401K125
K125PL18
K125HG50
K125NA70

corpo alluminio pressofuso
e estruso
*body in die casting
and extruded aluminium*
*corps en aluminium moulé
sous pression et extrudé*
*cuerpo aluminio inyectado
y extrusionado*
*Körper aus Aluminium-
Druckguss*

diffusore policarbonato opale
diffuser polycarbonate opal
diffuser polycarbonate opale
difusor policarbonato ópalo
Diffuser Polykarbonat opal

For technical details visit
www.landa.it

IP44

850°

FINISHING

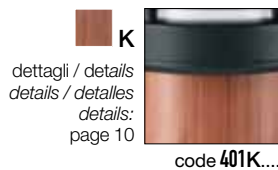

dettagli / details
details / detalles
details:
page 10

code 401K....

Wood that isn't wood

Processo produttivo non inquinante
Production process is not polluting
C'est un procédé productif non polluant
Proceso productivo no contaminante
Chemierückstand und Abwasser

COLOURS

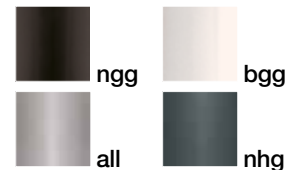

ELECTRIFICATION

<p>1 x 75 W</p> <p>401.00 .03</p> <p>1 x 100 W</p> <p>401.045 .075 .100 .125</p> <p>401K045 K075 K100 K125</p>	<p>1 x 23W</p> <p>5,3</p> <p>16,5</p>	<p>1 x 20 W</p> <p>5,3</p> <p>16,5</p>	<p>E27</p> <p>PL18</p> <p>1 x 18 W</p> <p>Gx24 q-2</p> <p>401.00 .03</p>	<p>401.045 .075 .100 .125</p> <p>401K045 K075 K100 K125</p>	<p>PL18</p> <p>1 x 18 W</p> <p>G24 d-2</p>	<p>HG50</p> <p>1 x 50 W</p> <p>E27</p> <p>mercury</p>	<p>NA70</p> <p>1 x 70 W</p> <p>E27</p> <p>metal halide and sodium</p>
--	---------------------------------------	--	--	---	--	---	---



Accessories on request:

Accessories not available for: 401.00 – 401.00PL18 – 401.03 – 401.03PL18



code 0404M004
Single connection IP68



code 0404M003
Loop in loop out IP68

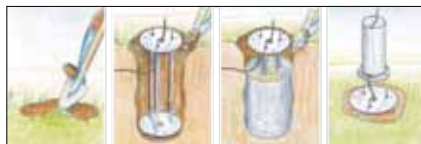

Root Mounting Kit code 00A400

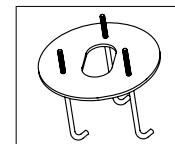
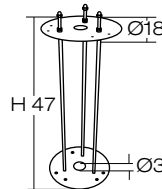

code 00A400.01P
Anchor Bolt

art.

800

design A. Dolcetti

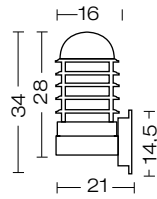

800.00
.00PL18

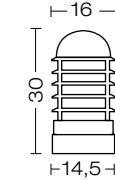

800.03
.03PL18

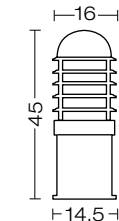

800.045
.045PL18

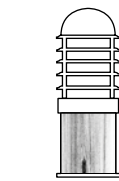

800K045
K045PL18

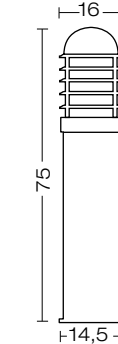

800.075
.075PL18
.075HG50
.075NA70



800K075
K075PL18
K075HG50
K075NA70

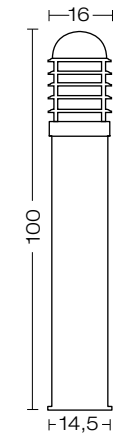

800.100
.100PL18
.100HG50
.100NA70

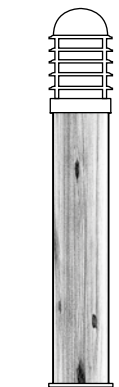

800K100
K100PL18
K100HG50
K100NA70

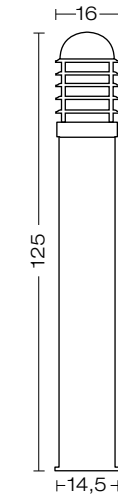

800.125
.125PL18
.125HG50
.125NA70



800K125
K125PL18
K125HG50
K125NA70

corpo acciaio inox AISI 316L
body stainless steel AISI 316L
corps acier inoxydable AISI 316L
cuerpo acero inox AISI 316L
Körper Edelstahl AISI 316L

diffusore policarbonato opale
diffuser polycarbonate opal
diffuser polycarbonate opale
difusor policarbonato ópalo
Diffuser Polykarbonat opal



stainless steel CLEANER
code OODEC
details: page 191

For technical details visit
www.landa.it

IP44

850°

FINISHING

K
dettagli / details
details / detalles
page 10



code 800K....

Wood that isn't wood

Processo produttivo non inquinante
Production process is not polluting
C'est un procédé productif non polluant
Proceso productivo no contaminante
Chemierückstand und Abwasser



code 800.....

ELECTRIFICATION

800.00	800.03	800.045	800K045	800.075	800K075	800.100	800K100	800.125	800K125
1x75 W	1x23 W	1x23 W	1x20 W	1x18 W	1x18 W	1x50 W	1x50 W	1x70 W	1x70 W
		5,3	5,3	Gx24 q-2	G24 d-2	E27	E27	E27	E27
		16,5	16,5			mercury	mercury	metal halide and sodium	metal halide and sodium



NEW
AISI 316L



Accessories on request:

Accessories not available for: 800.00 – 800.00PL18 – 800.03 – 800.03PL18



code 0404M004
Single connection IP68



code 0404M003
Loop in loop out IP68

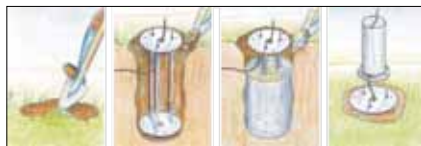

Root Mounting Kit code 00A400

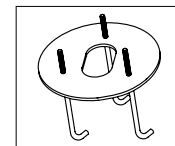
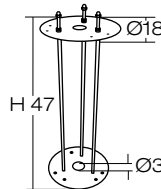

code 00A400.01P
Anchor Bolt

example code:

art.	finishing	size	electrification
801	K	100	HG50

COUNTRY example code:

art.	finishing	size	electrification
801	K	100	HG50

art.

801

design A. Dolcetti

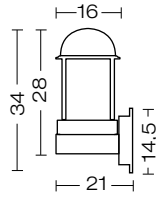

801.00
.00PL18

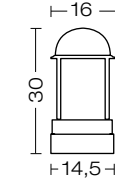

801.03
.03PL18

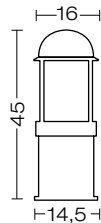

801.045
.045PL18



801K045
K045PL18

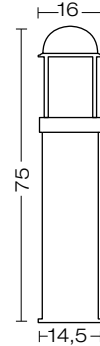

801.075
.075PL18
.075HG50
.075NA70

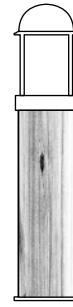

801K075
K075PL18
K075HG50
K075NA70

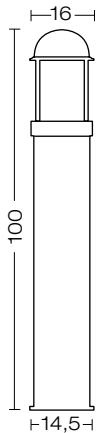

801.100
.100PL18
.100HG50
.100NA70



801K100
K100PL18
K100HG50
K100NA70

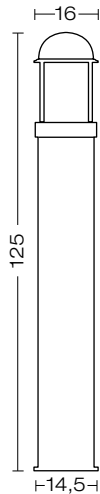

801.125
.125PL18
.125HG50
.125NA70



801K125
K125PL18
K125HG50
K125NA70

corpo acciaio inox AISI 316L
body stainless steel AISI 316L
corps acier inoxydable AISI 316L
cuerpo acero inox AISI 316L
Körper Edelstahl AISI 316L

diffusore policarbonato opale
diffuser polycarbonate opal
diffuser polycarbonate opale
difusor policarbonato ópalo
Diffuser Polykarbonat opal



stainless steel CLEANER
code OODEC
details: page 191

For technical details visit
www.landa.it

IP44

850°

FINISHING



dettagli / details
details / detalles
page 10



code 801K....

Wood that isn't wood

Processo produttivo non inquinante
Production process is not polluting
C'est un procédé productif non polluant
Proceso productivo no contaminante
Chemierückstand und Abwasser



code 801.....

ELECTRIFICATION

Code	Power	Base	Base Dimensions	Base Diagram	Code	Power	Base	Base Dimensions	Base Diagram	Code	Power	Base	Base Dimensions	Base Diagram
801.00	1x75 W	E27	1x20 W	5,3	801.045	1x18 W	PL18	5,3		801.075	1x18 W	PL18	5,3	
.03	1x23 W	E27	1x20 W	5,3	.075	Gx24 q-2	PL18	5,3		.100	Gx24 d-2	PL18	5,3	
.045	16,5	E27	1x20 W	5,3	.125	Gx24 d-2	PL18	5,3		801K045	1x50 W	HG50	5,3	
.075	16,5	E27	1x20 W	5,3	K075	mercury	HG50	5,3		K100	E27	HG50	5,3	
.100	16,5	E27	1x20 W	5,3	K100	metal halide and sodium	NA70	5,3		K125	E27	NA70	5,3	
.125	16,5	E27	1x20 W	5,3	K125	metal halide and sodium	NA70	5,3				NA70	5,3	



NEW
AISI 316L



Accessories on request:

Accessories not available for: 801.00 – 801.00PL18 – 801.03 – 801.03PL18



code 0404M004
Single connection IP68



code 0404M003
Loop in loop out IP68

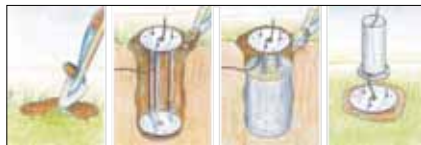

Root Mounting Kit code 00A400

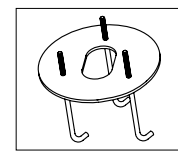
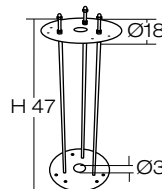

code 00A400.01P
Anchor Bolt

art.	electrification	finishing	size
810	F18	.	20

art.	electrification	finishing	size
810	F18	K	20

art.

810

design Ufficio Tecnico Landa

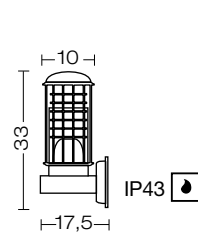

810.00
F18.00

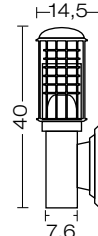

810.20
F18.20

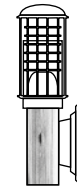

810K20
F18K20

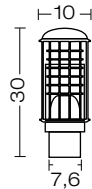

810.03
F18.03



810K03
F18K03

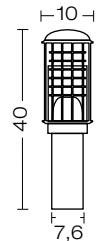

810.040
F18.040



810K040
F18K040

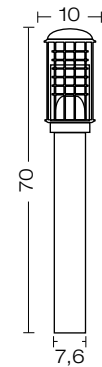

810.070
F18.070

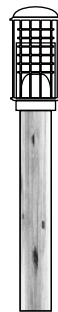

810K070
F18K070

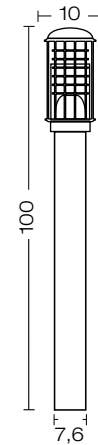

810.100
F18.100

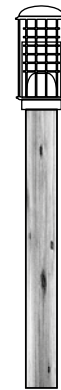

810K100
F18K100

corpo acciaio inox AISI 316L
body stainless steel AISI 316L
corps acier inoxydable AISI 316L
cuerpo acero inox AISI 316L
Körper Edelstahl AISI 316L

diffusore policarbonato
trasparente
diffuser transparent
polycarbonate
diffuser polycarbonate
transparent
difusor policarbonato
transparente
Diffuser Polykarbonat klar



stainless steel CLEANER
code OODEC
details: page 191

For technical details visit
www.landa.it

IP44

960°

FINISHING

K
dettagli / details
details / detalles
details:
page 10



code 810K....

Wood that isn't wood

Processo produttivo non inquinante
Production process is not polluting
C'est un procédé productif non polluant
Proceso productivo no contaminante
Chemierückstand und Abwasser



code 810.....

ELECTRIFICATION

Model	Electrification	Light Bulb
810.00	1 x 60 W	
810.20	1 x 23 W	
.03	1 x 23 W	
.040	E27 1 x 20 W	
.070	E27 1 x 20 W	
.100	F18 1 x 18 W Gx24 q-2	



NEW
AISI 316L

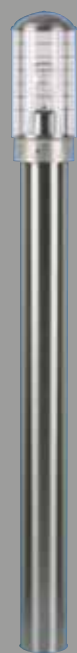

Accessories on request:



code 0404M004
Single connection IP68

colonna 52

example code:

art.	electrification	finishing	size
430	F18	.	070

INOX example code:

art.	electrification	finishing	size
9200	F18	.	070

art.

430 9200/2

design Ufficio Tecnico Landa



corpo alluminio estruso
body extruded aluminium
corps en aluminium extrudé
cuerpo aluminio extrusionado
Körper Aluminium

COLOUR



430

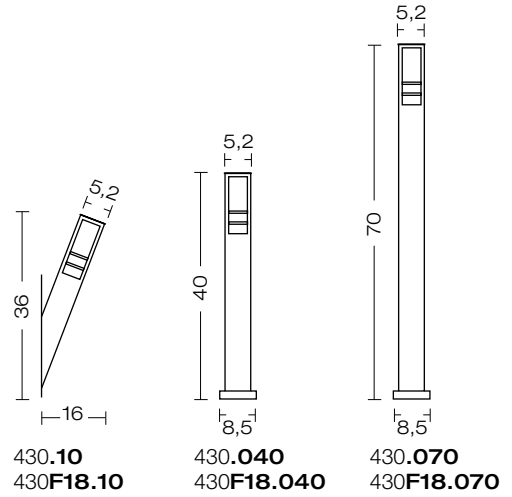

diffusore policarbonato opale
diffuser opal polycarbonate
diffuser polycarbonate opale
difusor policarbonato ópalo
Diffuser Polykarbonat opal



corpo acciaio inox AISI 316L
body stainless steel AISI 316L
corps acier inoxydable AISI 316L
cuerpo acero inox AISI 316L
Körper Edelstahl AISI 316L



9200 / 9202

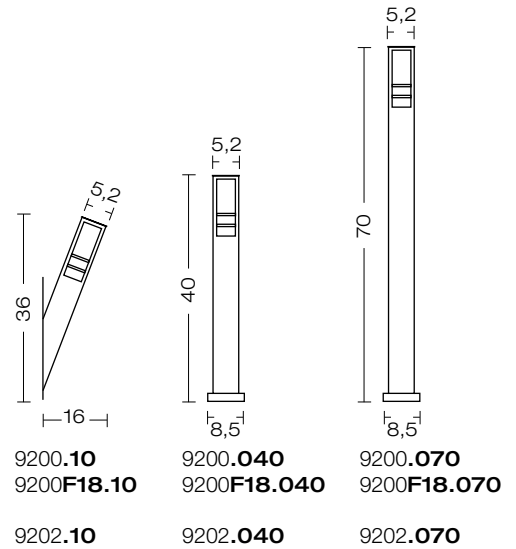

stainless steel CLEANER
code OODEC
details: page 191

For technical details visit
www.landa.it

IP44

850°



diffusore policarbonato opale
diffuser opal polycarbonate
diffuser polycarbonate opale
difusor policarbonato ópalo
Diffuser Polykarbonat opal

9200



diffusore vetro opale
diffuser glass opal
diffuser verre opale
difusor vidrio ópalo
Diffuser Glas opal

9202

ELECTRIFICATION

E14 1 x 11 W		E14 1 x 60 W		F18 1 x 18 W G24 q-2	
430.10	9200.10	9202.10			
.040	.040	.040			
.070	.070	.070			



NEW
AISI 316L



colonna 76

example code:

art.	electrification	finishing	size
435	F18	.	055

INOX example code:

art.	electrification	finishing	size
9240	F18	.	055

art.
435
9240

design Ufficio Tecnico Landa



corpo alluminio estruso
body extruded aluminium
corps en aluminium extrudé
cuerpo aluminio extrusionado
Körper Aluminium

435

COLOUR

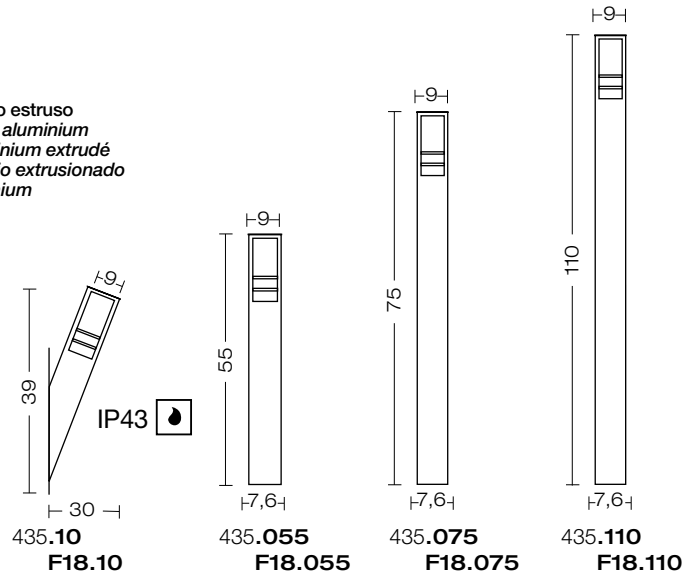

diffusore policarbonato opale
diffuser polycarbonate opal
diffuser polycarbonate opale
difusor policarbonato ópalo
Diffuser Polykarbonat opal



stainless steel CLEANER
code OODEC
details: page 191

For technical details visit
www.landa.it

IP44

850°



corpo acciaio inox AISI 316L
body stainless steel AISI 316L
corps acier inoxydable AISI 316L
cuerpo acero inox AISI 316L
Körper Edelstahl AISI 316L

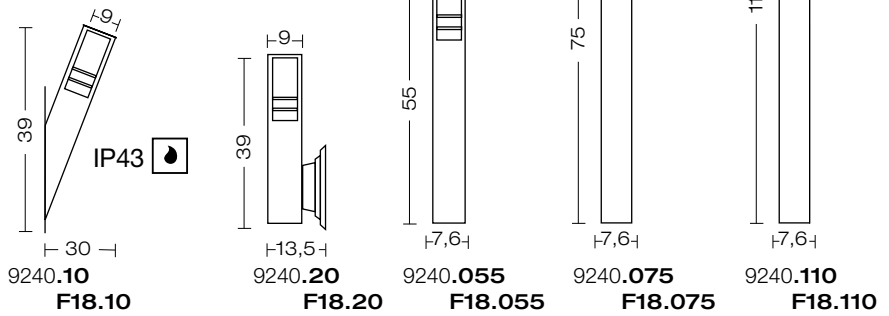

9240



NEW
AISI 316L

Accessories on request:

ELECTRIFICATION

E27		F18
1 x MAX 23 W		1 x 18 W
		Gx24 q-2
435.10	9240.10	
.055	.20	
.075	.055	
.110	.075	
	.110	
		



code 0404M004
Single connection IP68



code 0404M003
Loop in loop out IP68



colonna 114 INOX

example code:

art.	electrification	finishing	size
9270	F18	.	20

art.
9270

design Ufficio Tecnico Landa

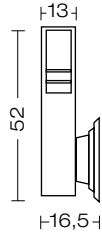

9270.20
F18.20



9270.055
F18.055

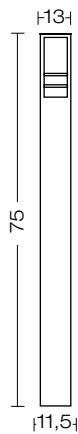

9270.075
F18.075

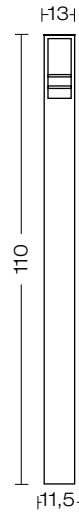

9270.110
F18.110

corpo acciaio inox AISI 316L
 body stainless steel AISI 316L
 corps acier inoxydable AISI 316L
 cuerpo acero inox AISI 316L
 Körper Edelstahl AISI 316L

diffusore policarbonato opale
 diffuser polycarbonate opal
 diffuser polycarbonate opale
 difusor policarbonato ópalo
 Diffuser Polykarbonat opal



stainless steel CLEANER
 code OODEC
 details: page 191

For technical details visit
www.landa.it

IP44

850°

Accessories on request:

ELECTRIFICATION

<p>1 x 75 W</p> <p>9270.20 .055 .075 .110</p>	<p>1 x 23 W</p> <p>5,3</p> <p>16,5</p>	<p>E27</p> <p>1 x 20 W</p> <p>5,3</p> <p>16,5</p>	<p>F18</p> <p>1 x 18 W</p> <p>Gx24 q-2</p>
---	--	---	--



code 0404M004
 Single connection IP68



code 0404M003
 Loop in loop out IP68



NEW
AISI 316L



serie/series

pali beta

LANDA®
illuminotecnica

art.

00PB126. 00PB060.

design Ufficio Tecnico Landa

corpo alluminio estruso
body extruded aluminium
corps en aluminium extrudé
cuerpo aluminio extrusionado
Körper Aluminium

dettagli accessori
details accessoires
details accessoires
detalles accesorios
details Zusatzgeräte
pages 119

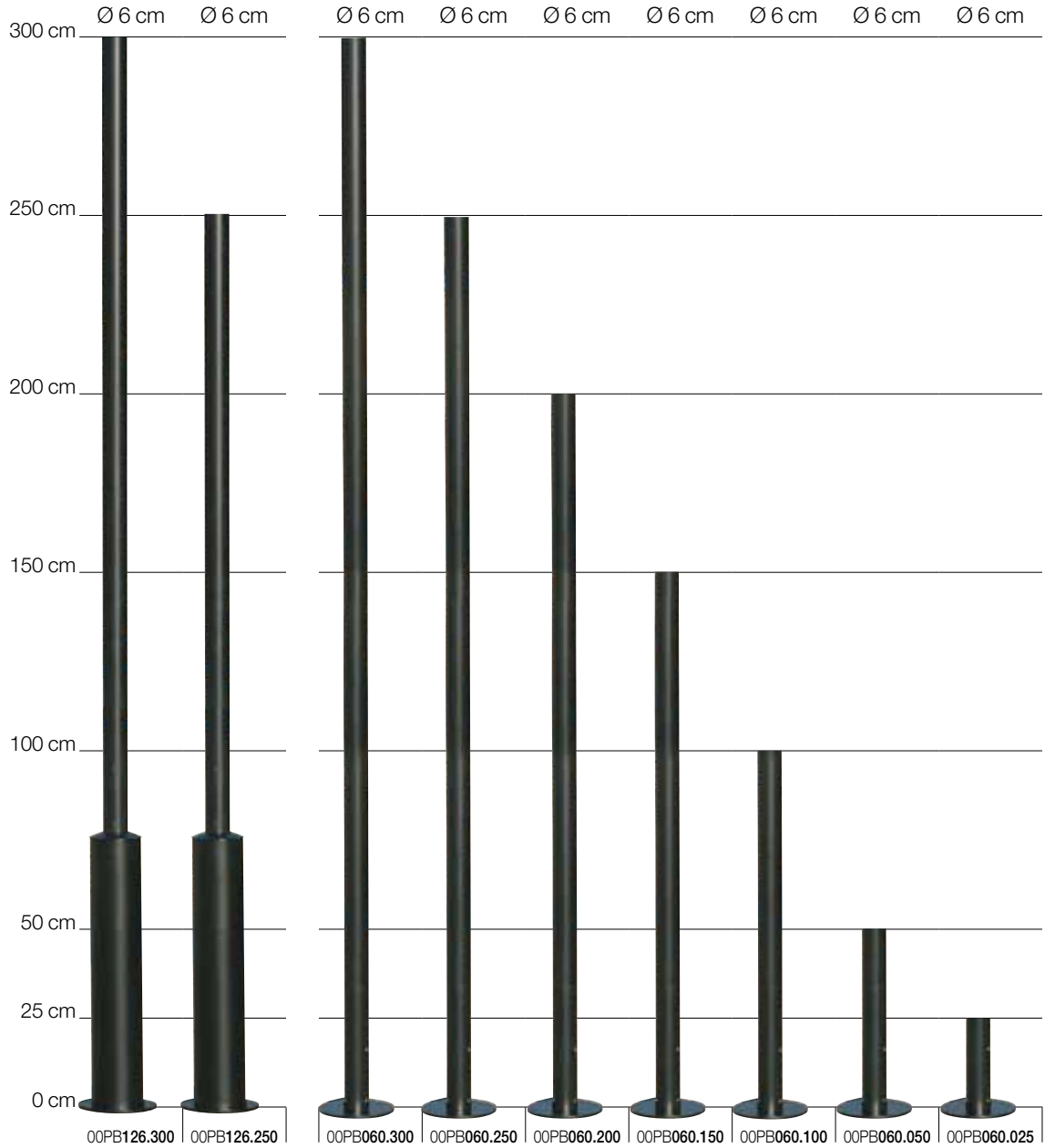

For technical details visit
www.landa.it



colori
colours
couleurs
colores
Farben
ngg

code 00PB126... ngg



Provided with door
inspection
code 00PB126.300
code 00PB126.250

Accessories on request:



code 0404M004
Single connection IP68



code 0404M003
Loop in loop out IP68

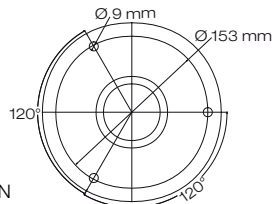

BASE DIMENSION

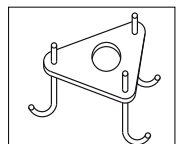

Anchor Bolt code 00APB

art.

00PB126
00PB060

design Ufficio Tecnico Landa
progetto Meta-Distrettuale Numa

corpo alluminio estruso
body extruded aluminium
corps en aluminium extrudé
cuerpo aluminio extrusionado
Körper Aluminium

dettagli accessori
details accessoires
details accessoires
detalles accesorios
details Zusatzgeräte
pages 119

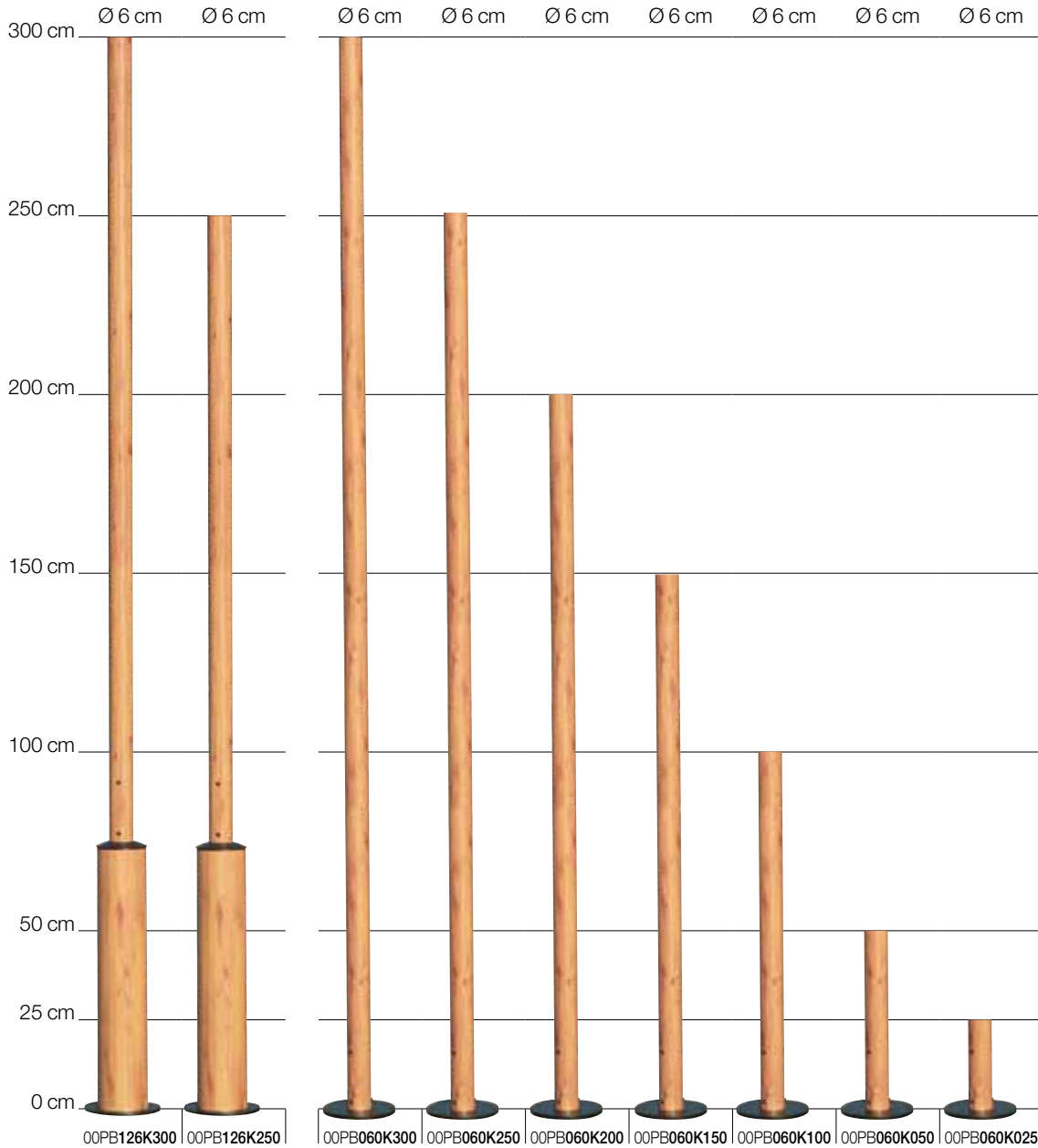

dettagli
details
details
detalles
details:
page 10



code 00PB126K....
code 00PB060K....

Wood that isn't wood

K
Processo produttivo non inquinante
Production process is not polluting
C'est un procédé productif non polluant
Proceso productivo no contaminante
Chemierückstand und Abwasser



Provided with door
inspection
code 00PB126K300
code 00PB126K250

For technical details visit
www.landa.it



code 0404M004
Single connection IP68



code 0404M003
Loop in loop out IP68

BASE DIMENSION

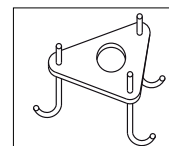
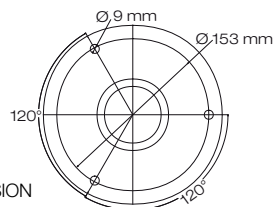

Anchor Bolt code 00APB

Accessories on request:

serie/series

LANDA®
illuminotecnica

pali liberty

art.

00P170.

design Ufficio Tecnico Landa

corpo alluminio pressofuso ed estruso
body in die casting aluminium and extruded
corps en aluminium mûlé sous pression et extrudé
cuerpo aluminio inyectado y extrusionado
Körper aus Aluminium-Druckguss

dettagli accessori
details accessoires
details accessoires
detalles accesorios
details Zusatzgeräte
pages 119



For technical details visit www.landa.it

colori
colours
couleurs
colores
Farben
■ ngg



Provided with door inspection

ELECTRIFICATION

Accessories on request:



code **0404M004**
Single connection IP68



code **0404M003**
Loop in loop out IP68

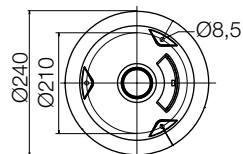

BASE DIMENSION

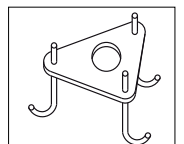

Anchor Bolt code **00A170.01P**

Example to order the accessories:

A3 + B2 + C1 =
art. 00E326F42 + art. 0203140 + art. 0203141N =



	art.	W	
A1	00E326E27	1 x 150	E27
A2	METAL HALIDE AND SODIUM 00E326H70	1 x 70	E27
A3	00E326F42	1 x 42	Gx24 q-4

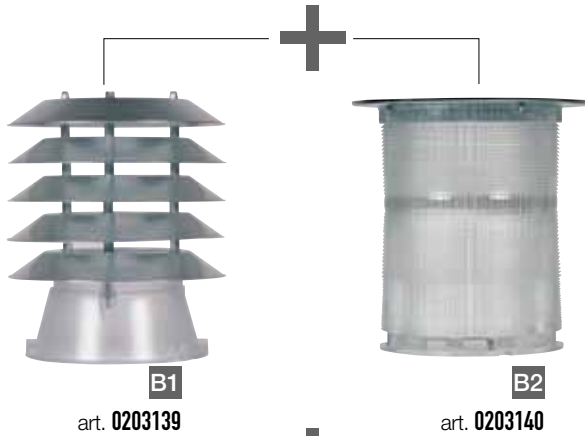

ACCESSORIES

corpo policarbonato
body polycarbonate
corps polycarbonate
cuerpo polycarbonato
Körper Polykarbonat

globo PMMA
globes PMMA
boules PMMA
Globo PMMA
Kugeln PMMA

For technical details visit
www.landa.it



example code:
 | art. | electrification | diffuser | colour |
 405 | F18 | B | nhg

art.

405 405B

designers Innocenzo Rifino
& Lorenzo Ruggieri

OHIM:
patent No.
000659917-0003

Beijing - China
HC-IP Agency Co., LTD
patent pending

corpo alluminio pressofuso
body in die casting aluminium
corps en aluminium moulé
sous pression
cuerpo aluminio inyectado
Körper aus Aluminium-
Druckguss

diffusore policarbonato
diffuser polycarbonate
diffuser polycarbonate
difusor policarbonato
Diffuser Polykarbonat

For technical details visit
www.landa.it

IP44 



405
405F18



405B
405F18B



405
405F18



405B
405F18B

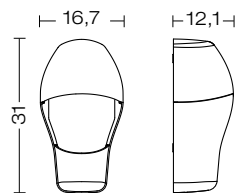

trasparente
transparent
transparent
transparente
klar

960°

code 405
405F18



opale
opal
opale
ópalo
opal

850°

code 405B
405F18B



ELECTRIFICATION

1 x MAX 75 W

405
405B



1 x 23 W

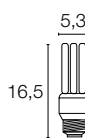

E27
1 x 16 W



F18
1 x 18 W
Gx24 q-2





dettagli-details
details-detalles
details:
pages 82+85

LED 12W
powered by Acriche
SEOUL® LED
AC direct connection
230/240V
Transformer not required

example code:
art. LED 10° | colour |
9008 L12 H all
example code:
art. electrification | colour |
9008 PL18 all

art.
9008

design Duse & Righetto

corpo alluminio pressofuso
body in die casting aluminium
corps en aluminium moulé
sous pression
cuerpo aluminio inyectado
*Körper aus Aluminium-
Druckguss*

diffusore policarbonato opale
diffuser polycarbonate opal
diffuser polycarbonate opale
difusor policarbonato ópalo
Diffuser Polykarbonat opal

LED 12W
powered by Acriche
SEOUL® LED
AC direct connection
230/240V
Transformer not required

LED 12W
powered by Acriche
SEOUL® LED
AC direct connection
230/240V
Transformer not required

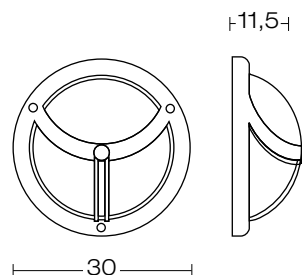
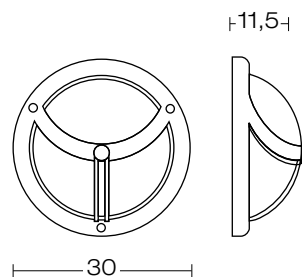
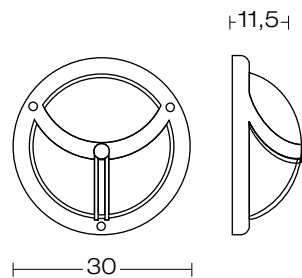
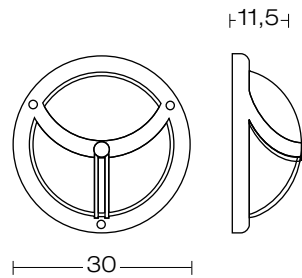

9008
9008PL18

sensor dettagli
details
detaills
detailles
details:
page 7
9008SEN

9008L12
L12H

sensor dettagli
details
detaills
detailles
details:
page 7
9008L12SEN
9008L12HSEN

For technical details visit
www.landa.it

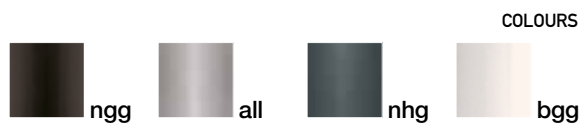

LED
detailli / details / details
detaills / details:
pages 4-5

Transformer not required
L12 LED 12 W 6000°K 780LM
L12H LED 12 W 3500°K 660LM

1 x 60 W
1 x 20 W
E27 1 x 16 W
9008
9008SEN

PL18
1 x 18 W
Gx24 d-2

cervinia



cervinia

example code:
 | art. | electrification | colour |
 9002 PL28 ngr

art.
9002
9006

design Ufficio Tecnico Landa



9002

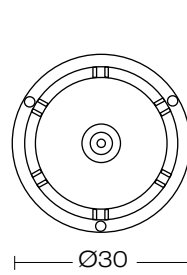

16

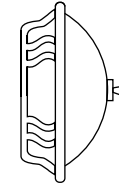

IP43

9002
 9002**PL28**



9006

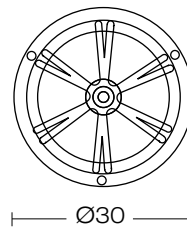

11,5



IP54

9006
 9006**PL18**



9006SEN

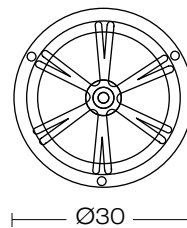

11,5



sensor



dettagli
 details
 details
 details:
 page 7

9006**SEN**

IP54

corpo alluminio
 body aluminium
 corps en aluminium
 cuerpo aluminio
 Körper aus Aluminium

diffusore policarbonato opale
 diffuser polycarbonate opal
 diffusor polycarbonato opale
 difusor policarbonato ópalo
 Diffuser Polykarbonat opal

For technical details visit
www.landa.it



COLOURS

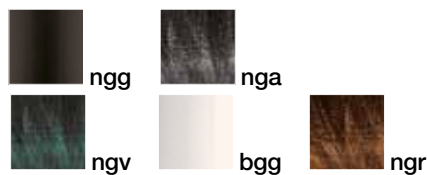

ELECTRIFICATION

E27 1 x 60 W	1 x 60 W	1 x 20 W	E27 1 x 16 W	PL28 1 x 28 W GR8	PL18 1 x 18 W G24 d-2
9002	9006 9006SEN				



art.



9001 9005

design Ufficio Tecnico Landa

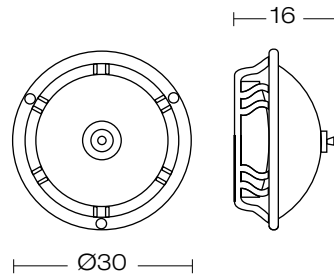

9001



IP43 
 9001 
 9001**PL28**



9005

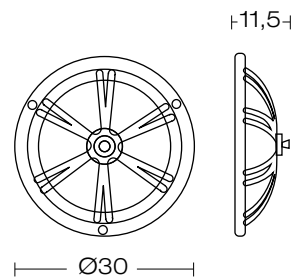

IP54 
 9005
 9005**PL18**

corpo acciaio inox
 body stainless steel
 corps acier inoxydable
 cuerpo acero inox
 Körper Edelstahl

diffusore policarbonato
 diffuser polycarbonate
 diffusor polycarbonate
 difusor policarbonato
 Diffuser Polykarbonat



stainless steel **CLEANER**
 code OODEC
 details: page 191

For technical details visit
www.landa.it



trasparente
 transparent
 transparent
 transparente
 klar

850°

code 9001
 9005









opale
 opal
 opale
 ópalo
 opal

850°

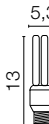
code 9001**PL28**
 9005**PL18**

ELECTRIFICATION

E27 1 x 60 W	1 x 60 W	1 x 20 W	E27 1 x 16 W	PL28 1 x 28 W GR8	PL18 1 x 18 W G24 d-2
					
9001	9005				



example code:

art.		electrification
9100		PL13

COUNTRY example code:

art.	finishing	electrification
9100	K	PL13

art.

9100
9103
9109

design Ufficio Tecnico Landa



9100K
9100KPL13
9100KF18
9100KSEN 

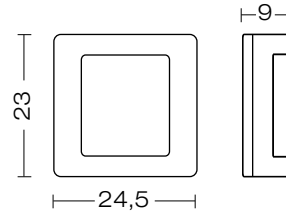

9100
9100PL13
9100F18
9100SEN 



9103
9103PL13
9103F18
9103SEN 

corpo acciaio inox AISI 316L
body stainless steel AISI 316L
corps acier inoxydable AISI 316L
cuerpo acero inox AISI 316L
Körper Edelstahl AISI 316L

diffusore policarbonato opale
diffuser polycarbonate opal
diffuser polycarbonate opale
difusor policarbonato ópalo
Diffuser Polykarbonat opal



9109
9109PL13
9109F18

personalizzazioni a laser
personalization with laser
personnalisations avec laser
personalizacio-nes laser
durch Laserung individuell zu gestalten



numeri inclusi
included numbers
nombres inclus
números incluido
einschließlich Nummern

9103N
9103NPL13
9103NF18

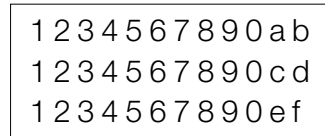

stainless steel CLEANER
code OODEC
details: page 191

For technical details visit
www.landa.it

IP44 

850° 

FINISHING

 K
dettagli / details
details / detalles
details:
page 10



code 9100K....

Wood that isn't wood

Processo produttivo non inquinante
Production process is not polluting
C'est un procédé productif non polluant
Proceso productivo no contaminante
Chemierückstand und Abwasser

NEW
AISI 316L



ELECTRIFICATION



dettagli
details
details
details:
page 7

9100K
9100KSEN
9100
9100SEN

9103
9103SEN
9109
9103N

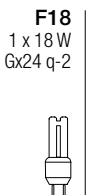
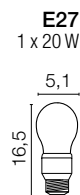
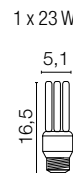



NEW
AISI 316L



serie/series
**linea
chicca**

example code:
| art. | electrification |
9111 | F18 |

serie/series
linea
art.
9111

design Ufficio Tecnico Landa

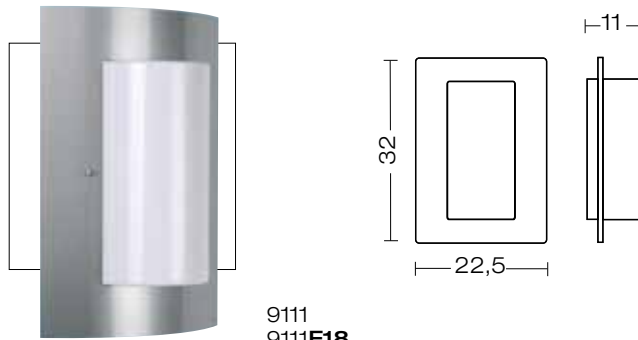

9111
9111F18

serie/series
chicca
art.

9122B
9123B

corpo acciaio inox AISI 316L
body stainless steel AISI 316L
corps acier inoxydable AISI 316L
cuerpo acero inox AISI 316L
Körper Edelstahl AISI 316L

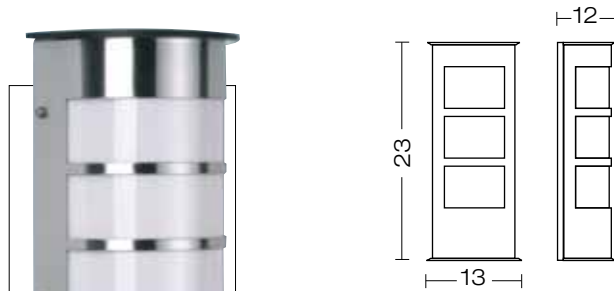

9122B
9122BF18



diffusore inferiore e superiore in plexiglass blu
bottom and upper blue plexiglass diffuser
diffuseur bleu en plexiglass inférieur et supérieur
difusor inferior y superior en plexiplás azul
unten und oben blaues Plexiglas

diffusore policarbonato opale
diffuser polycarbonate opal
diffuser polycarbonate opale
difusor policarbonato ópalo
Diffuser Polykarbonat opal



stainless steel CLEANER
code OODEC
details: page 191



9123B
9123BF18

For technical details visit
www.landa.it

IP44

850°

ELECTRIFICATION

	1 x 60 W	1 x 23 W	E27 1 x 20 W	F18 1 x 18 W Gx24 q-2
9111				
9122B				
9123B				



NEW
AISI 316L



lampara INOX

example code:

art.	electrification	finishing	size
9500	F18	.	PA4T1

art.
9500

design Ufficio Tecnico Landa



corpo acciaio inox AISI 316L
 body stainless steel AISI 316L
 corps acier inoxydable AISI 316L
 cuerpo acero inox AISI 316L
 Körper Edelstahl AISI 316L

diffusore policarbonato
 trasparente
 diffuser transparent
 polycarbonate
 diffuser polycarbonate
 transparent
 difusor policarbonato
 transparente
 Diffuser Polykarbonat klar



stainless steel CLEANER
 code OODEC
 details: page 191

For technical details visit
www.landa.it

IP44

850°

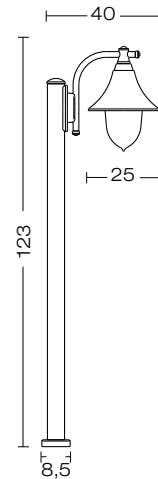
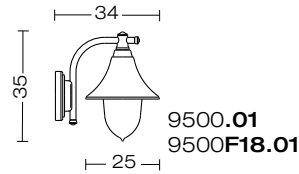

9500.PA4T1
 9500F18.PA4T1

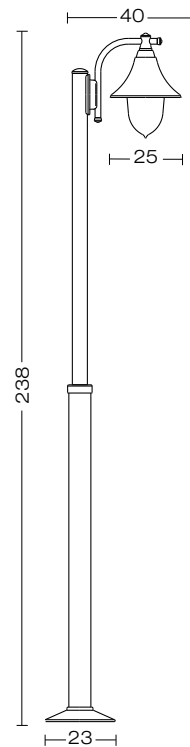

9500.PA6T1
 9500F18.PA6T1

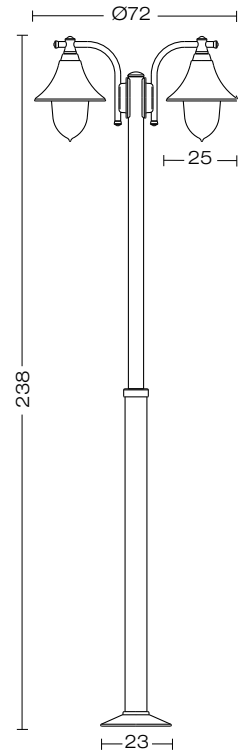



9500.PA6T2
 9500F18.PA6T2

ELECTRIFICATION

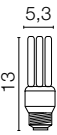
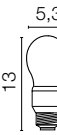
1 x 100 W 23 W
9500.00
.PA4T1
.PA6T1
 2 x
9500.PA6T2

E27
 20 W
9500F18.01
F18.PA4T1
F18.PA6T1
 2 x
9500F18.PA6T2

F18
 18 W
 Gx24 q-2



NEW
AISI 316L



Accessories on request:

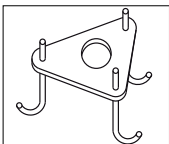

code **00APA6**
Anchor Bolt

available for:
9500.PA6T1
9500F18.PA6T1
9500.PA6T2
9500F18.PA6T2

saturno mini

example code:

art.	electrification	finishing	size
9420	F18	.	01B

art.

9420

design Ufficio Tecnico Landa

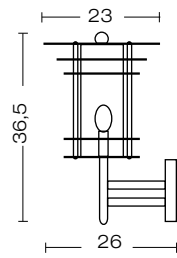

9420.00
.00B
F18.00B

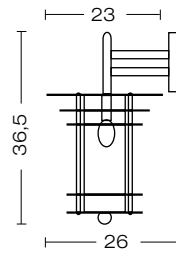

9420.01
.01B
F18.01B

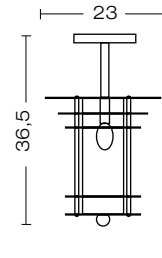

9420.02F
.02FB
F18.02FB

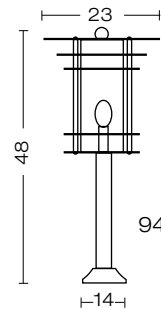

9420.04
.04B
F18.04B

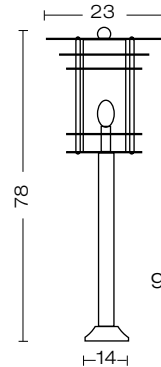

9420.14
.14B
F18.14B

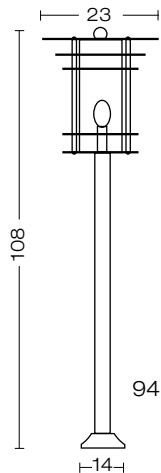

9420.24
.24B
F18.24B

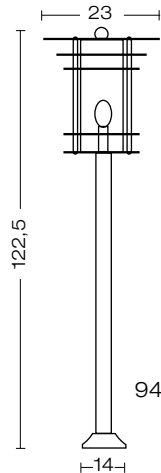

9420.34
.34B
F18.34B

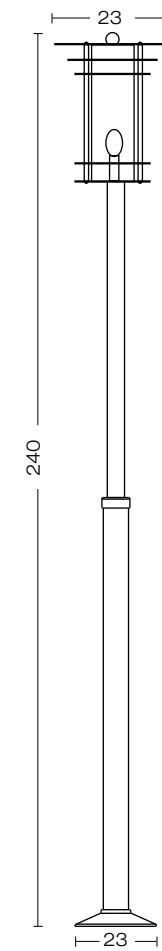

9420.PA6
.PA6B
F18.PA6B

corpo acciaio inox AISI 316L
 body stainless steel AISI 316L
 corps acier inoxydable AISI 316L
 cuerpo acero inox AISI 316L
 Körper Edelstahl AISI 316L

diffusore policarbonato
 diffuser polycarbonate
 diffusor polycarbonate
 difusor policarbonato
 Diffuser Polykarbonat



stainless steel CLEANER
 code OODEC
 details: page 191

For technical details visit
www.landa.it

IP43



trasparente
 transparent
 transparent
 transparente
 klar

960°

code 9420....



opale
 opal
 opale
 ópalo
 opal

850°

code 9420...B

ELECTRIFICATION

1 x 60 W
9420.01
.02F

1 x 75 W
9420.00
.04
.14
.24
.34
.PA6



1 x 23 W
 5,3
 16,5



E27
 1 x 20 W
 5,3
 16,5

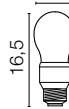

F18
 1 x 18 W
 Gx24 q-2





NEW
AISI 316L



Accessories on request:

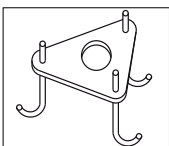

code **00APA6**
Anchor Bolt

available for:
9420.PA6
9420.PA6B
9420F18.PA6B

urano mini

example code:			
art.	electrification	finishing	size
9440	F18	.	34B

art.

9440

design Ufficio Tecnico Landa

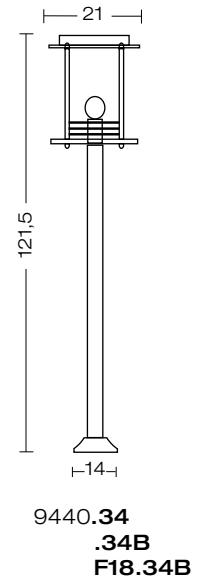
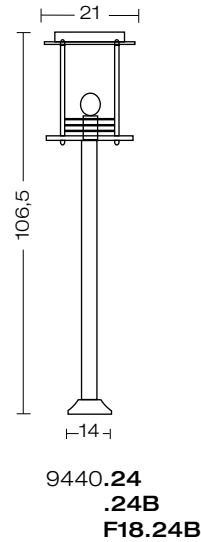
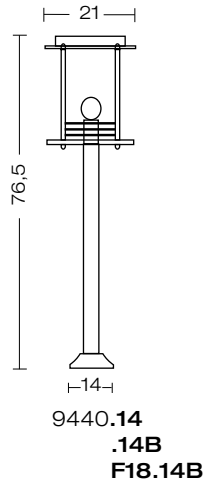
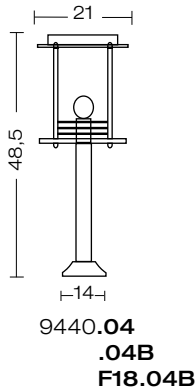
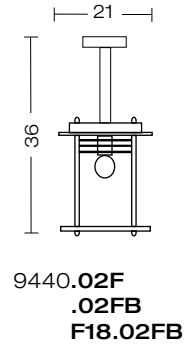
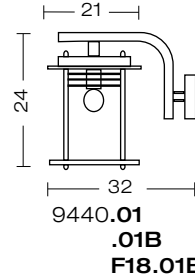
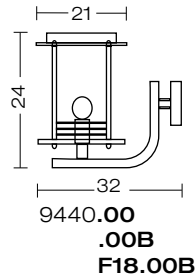

corpo acciaio inox AISI 316L
body stainless steel AISI 316L
corps acier inoxydable AISI 316L
cuero acero inox AISI 316L
Körper Edelstahl AISI 316L

diffusore policarbonato
diffuser polycarbonate
diffuser polycarbonate
difusor policarbonato
Diffuser Polykarbonat



stainless steel CLEANER
code OODEC
details: page 191

For technical details visit
www.landa.it

IP43



ELECTRIFICATION

1 x 60 W 9440.01 .02F	1 x 75 W 9440.00 .04 .14 .24 .34 .PA6	1 x 23 W 5,3 16,5	E27 1 x 20 W 5,3 16,5	F18 1 x 18 W Gx24 q-2
-----------------------------	---	-------------------------	--------------------------------	-----------------------------



NEW
AISI 316L



serie/series

antares

example code:			
art.	electrification	finishing	size
9490	F18	.	00B

art.

9490

design Ufficio Tecnico Landa

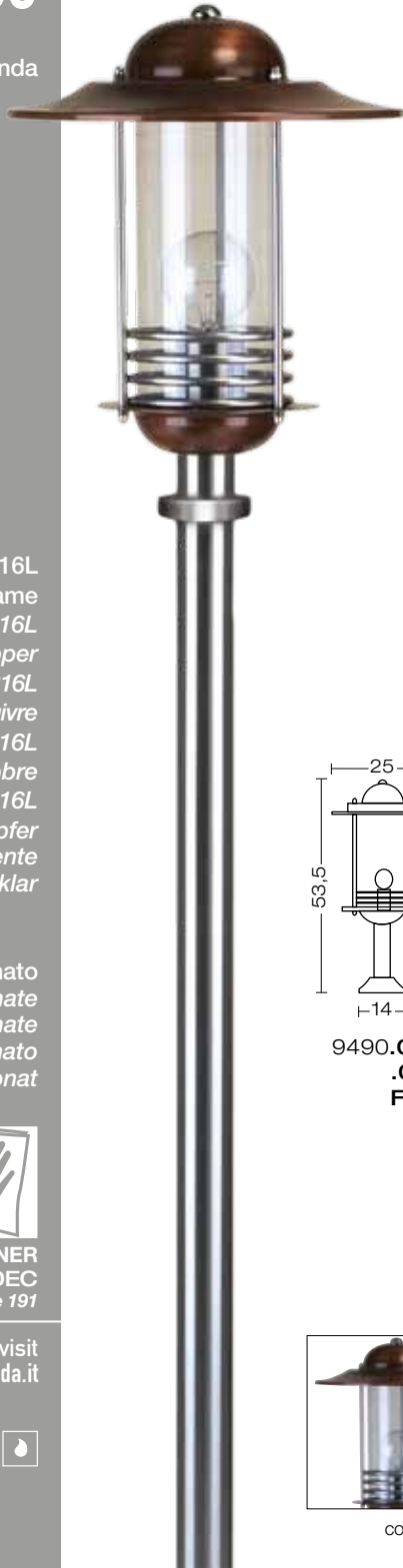

corpo acciaio inox AISI 316L
e rame
body stainless steel AISI 316L
and copper
corps acier inoxydable AISI 316L
at cuivre
cuerpo acero inox AISI 316L
y cobre
Körper Edelstahl AISI 316L
und kupfer
transparente
Diffuser Polykarbonat klar

diffusore policarbonato
diffuser polycarbonate
diffuser polycarbonate
difusor policarbonato
Diffuser Polykarbonat



stainless steel CLEANER
code OODEC
details: page 191

For technical details visit
www.landa.it

IP43

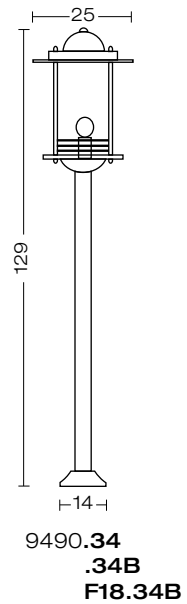
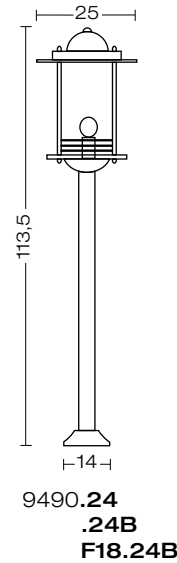
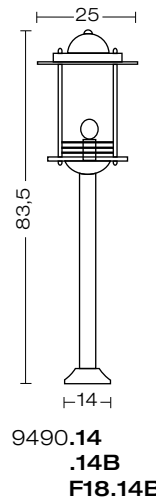
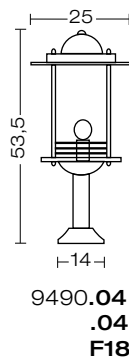
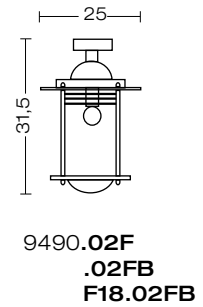
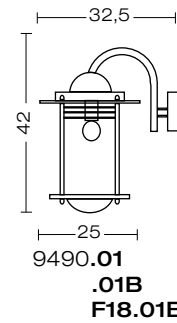
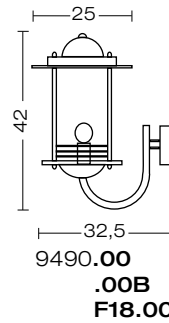

trasparente
transparent
transparent
transparente
klar

960°

code 9490....



opale
opal
opale
ópalo
opal

850°

code 9490....B

ELECTRIFICATION

1 x 60 W
9490.01
.02F

1 x 75 W
9490.00
.04
.14
.24
.34

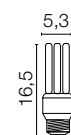

F18
1 x 18 W
Gx24 q-2





ENERGY
SAVING

NEW
AISI 316L



serie/series

pali

posts/poteaux
postes/Maste

Nuovi pali fissi realizzati tramite fusione e profilati - *New cast and extruded fixed posts* - *Nouveaux poteaux réalisés par fusion et extrusion* - *Nuevos postes fijos producidos en aluminio inyectado y perfilado* - *Neue fixe Maste aus Aluminiumdruckguss und Stranggepresst*

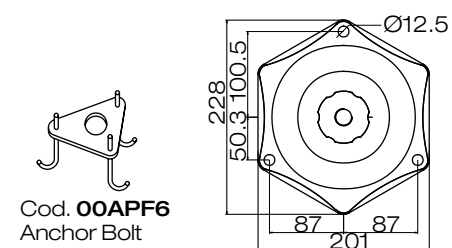
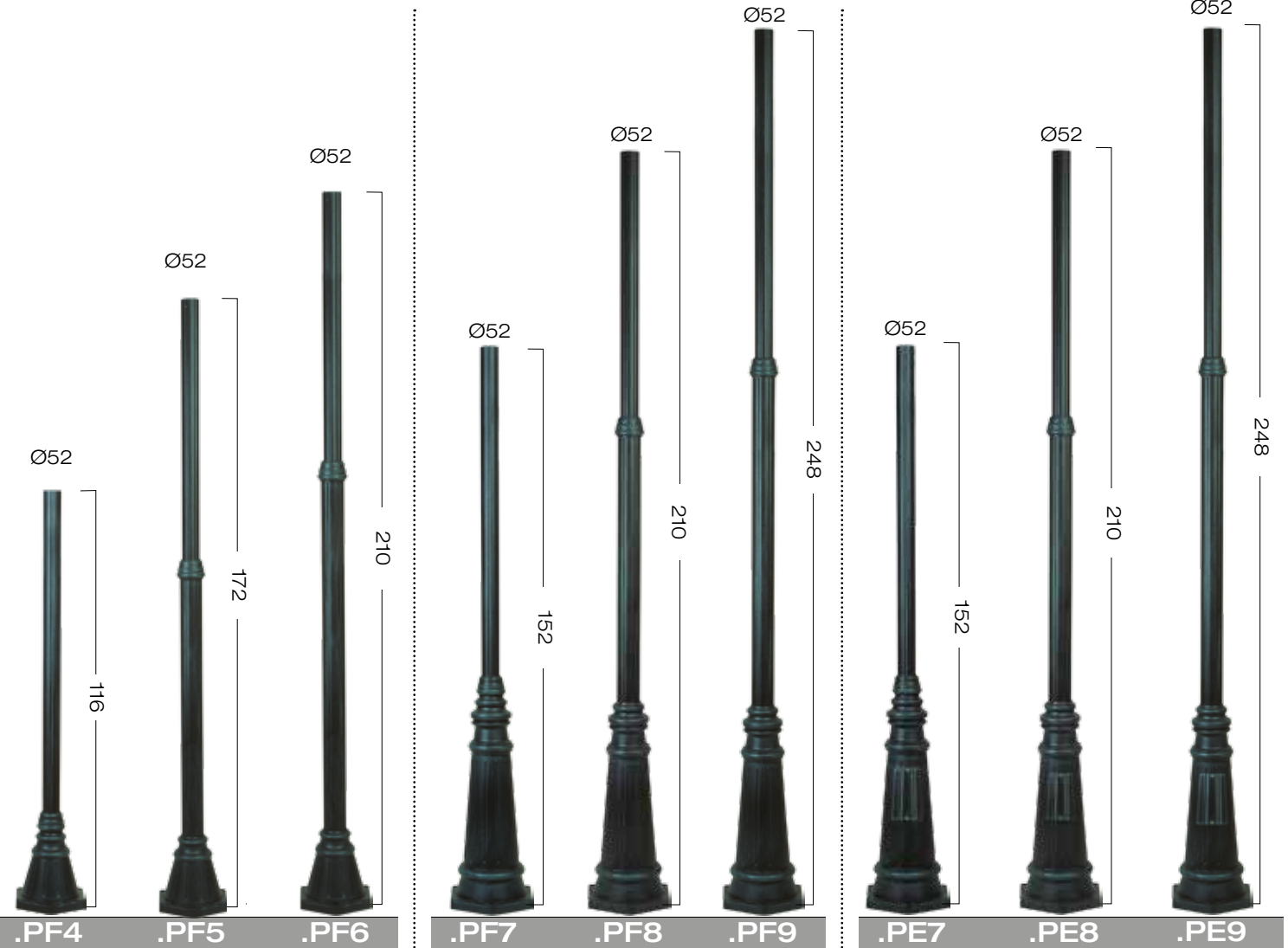

Cod. **00APF6**
Anchor Bolt

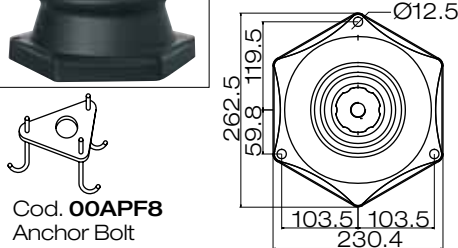

Cod. **00APF8**
Anchor Bolt

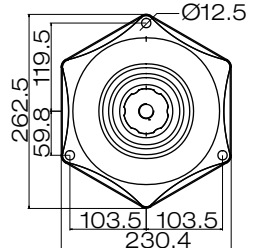

Cod. **00PF8**
Anchor Bolt



CODE: **00CRP** for posts: **.PF - .PE - .PR**

pali
posts/poteaux
postes/Maste

Nuovi pali regolabili in altezza realizzati tramite fusione e profilati. - *New cast and extruded posts with adjustable height.* - *Nouveaux poteaux réglables en hauteur réalisés par fusion et extrusion.* - *Nuevos postes ajustables en altura en aluminio inyectado y perfilado.* - *Neue höhenverstellbare Maste aus Aluminiumdruckguss und stranggepresst.*

- Piastra in acciaio compressa
- *Stainless steel plate included*
- Embase en acier inox comprise
- *Chepa en acer inox incluida*
- *Edelstahl Platte inklusive*

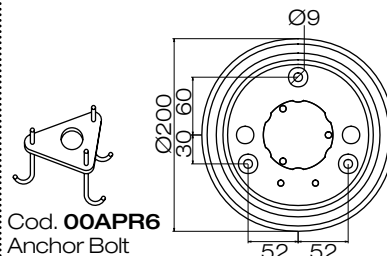
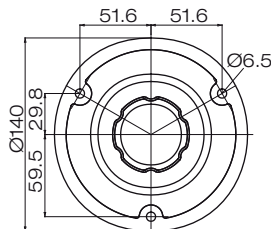
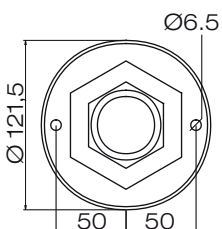
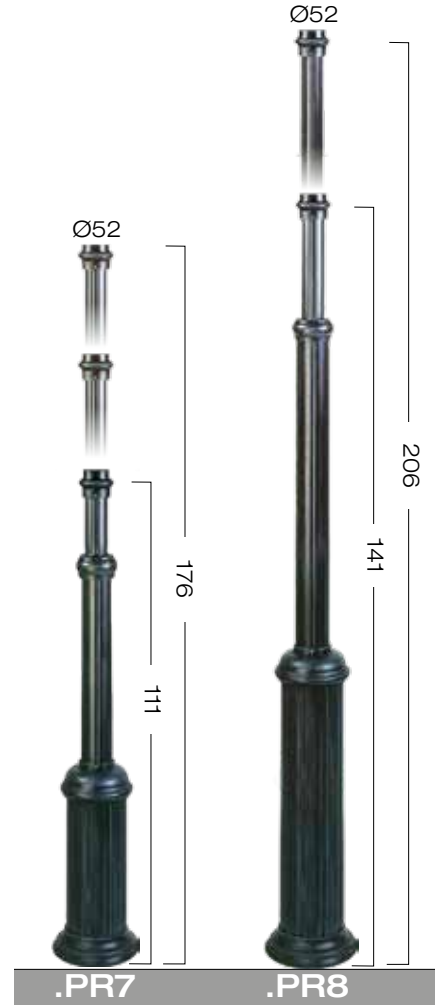
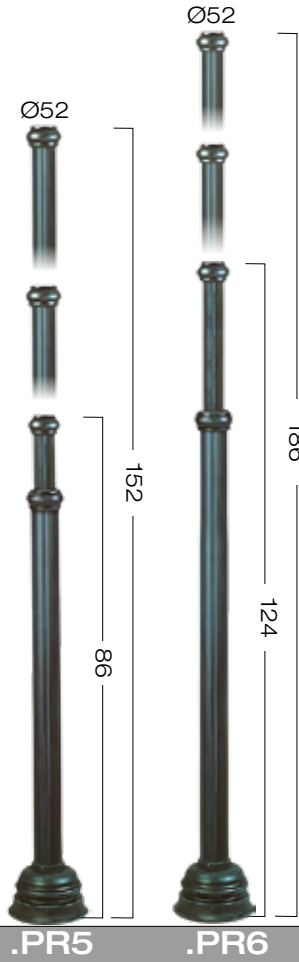
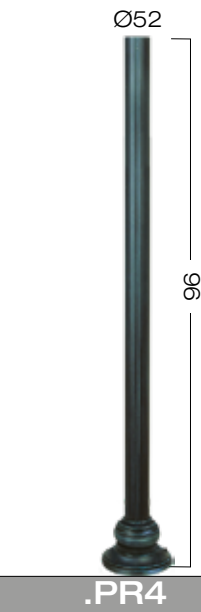
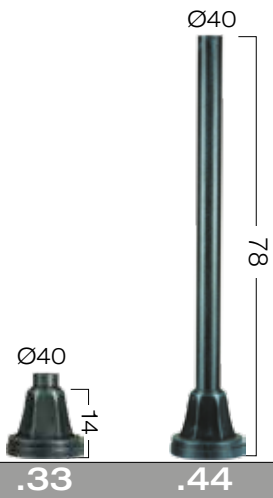

Cod. **00APR6**
Anchor Bolt

Cod. **00APR8**
Anchor Bolt

art.
370

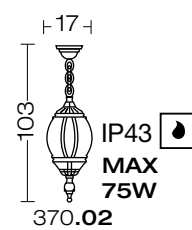
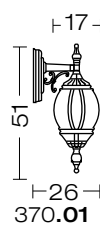
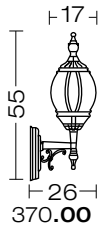
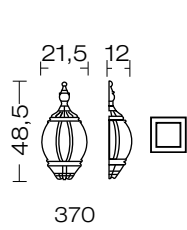

corpo alluminio pressofuso
body in die casting
aluminium
corps en aluminium moulé
sous pression
cuerpo aluminio inyectado
Körper aus Aluminium-
Druckguss

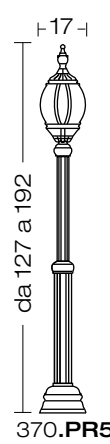
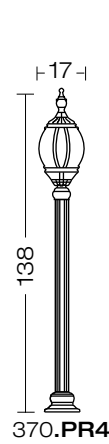
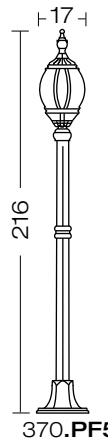
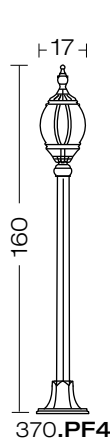
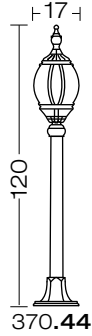
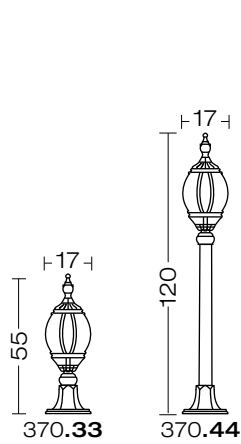

diffusore policarbonato
trasparente
diffuser transparent
polycarbonate
diffuser polycarbonate
transparent
difusor policarbonato
transparente
Diffuser Polykarbonat klar

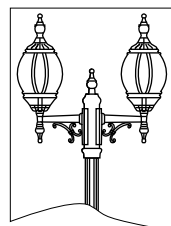

370.....T2

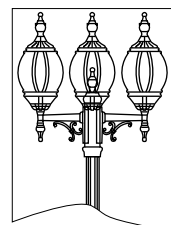

370.....T3

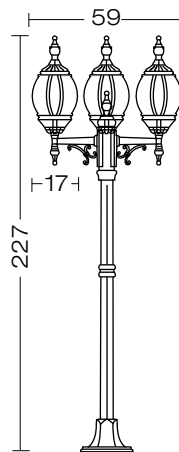

370.PF5T2
370.PF5T3

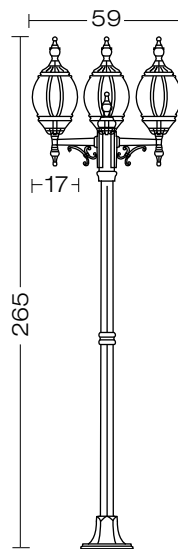

370.PF6T2
370.PF6T3

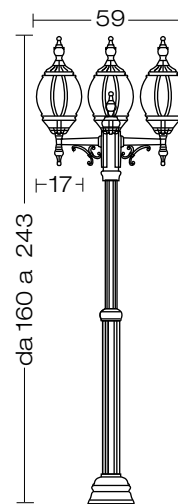

370.PR6T2
370.PR6T3

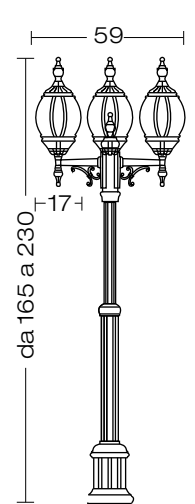

370.PR7T2
370.PR7T3

dettagli - details
- details - detalles - details:
pages 138-139

For technical details visit
www.landa.it



ELECTRIFICATION

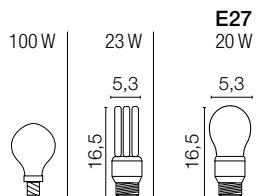

COLOURS

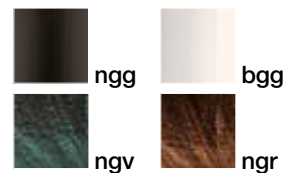



Accessories on request:



code **0404M004**
Single connection IP68



code **0404M003**
Loop in loop out IP68

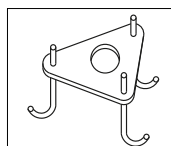

370.PF4.....
370.PF5.....
370.PF6.....
Anchor Bolt: code **00APF6**

370.PR5.....
370.PR6.....
code **00APR6**

370.PR7.....
code **00APR8**

example code:

art.	finishing	size	colour
372	.	01	ngg

art.

371-372

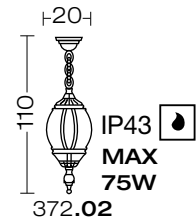
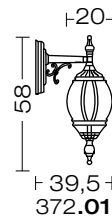
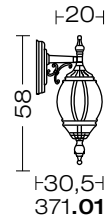
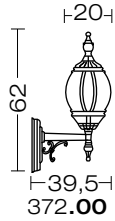
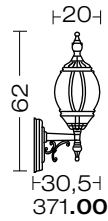

corpo alluminio pressofuso
body in die casting aluminium
corps en aluminium moulé
sous pression
cuerpo aluminio inyectado
Körper aus Aluminium-
Druckguss

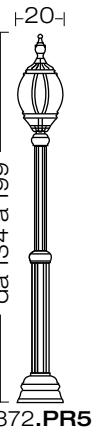
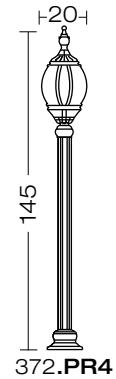
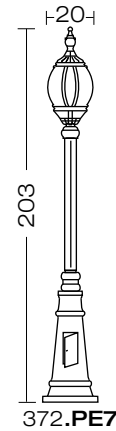
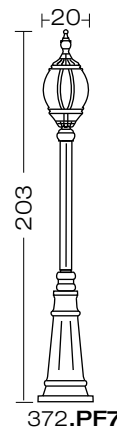
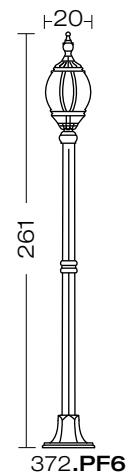
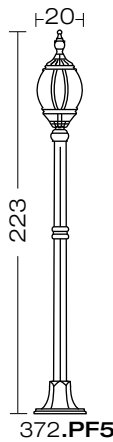
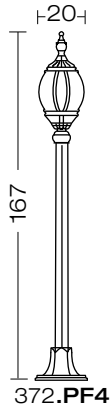
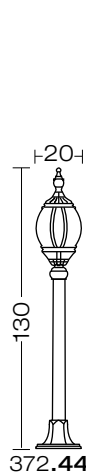

diffusore policarbonato
trasparente
diffuser transparent
polycarbonate
diffuser polycarbonate
transparent
difusor policarbonato
transparente
Diffuser Polykarbonat klar

dettagli - details
- details - detalles - details:
pages 138-139

For technical details visit
www.landa.it

IP44

960°

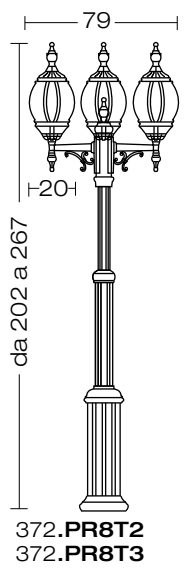
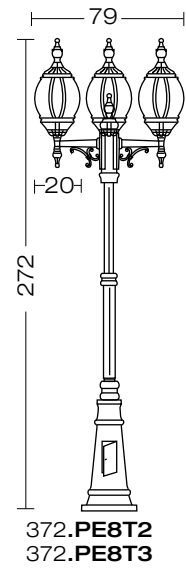
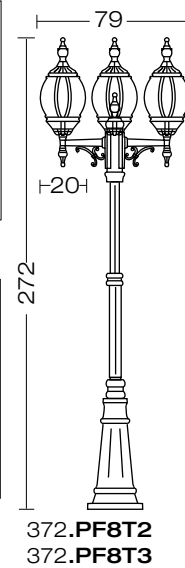
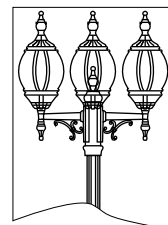
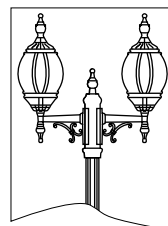
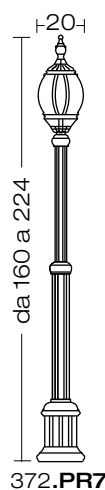

ELECTRIFICATION

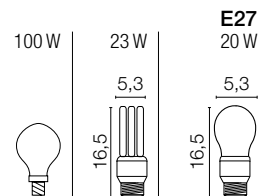

COLOURS





Accessories on request:



code **0404M004**
Single connection IP68



code **0404M003**
Loop in loop out IP68

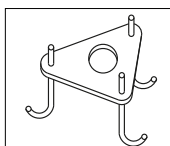

Anchor Bolt: code **00APF6**

372.PF4.....
372.PF5.....
372.PF6.....

372.PF7.....
372.PF8.....
372.PE7.....
372.PE8.....

code **00APF8**

372.PR5.....
372.PR6.....

code **00APR6**

372.PR7.....
372.PR8.....

code **00APR8**

serie/series

parigi maxi

example code:

art.	finishing	size	colour
374	.	00	ngv

art.

373-374

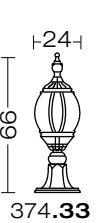
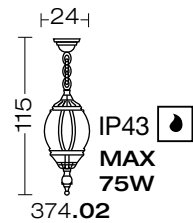
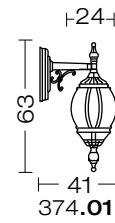
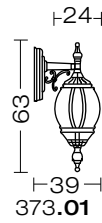
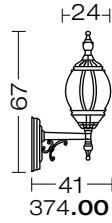
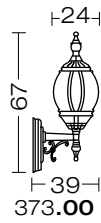

corpo alluminio pressofuso
body in die casting aluminium
corps en aluminium moulé
sous pression
cuerpo aluminio inyectado
Körper aus Aluminium-
Druckguss

diffusore policarbonato
trasparente
diffuser transparent
polycarbonate
diffuser polycarbonate
transparent
difusor policarbonato
transparente
Diffuser Polykarbonat klar

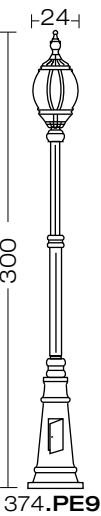
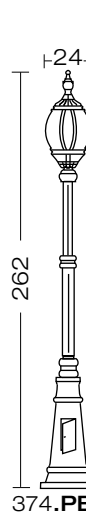
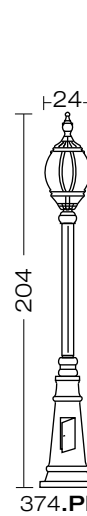
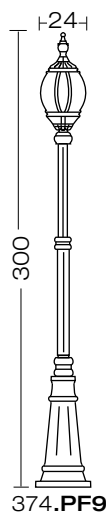
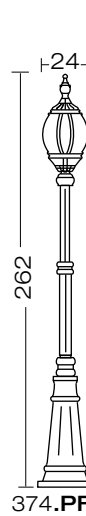
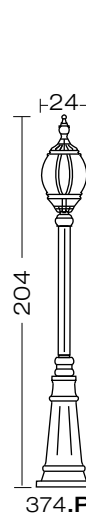
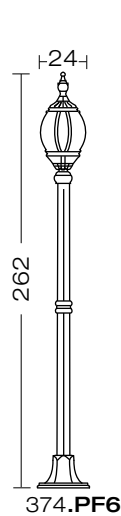
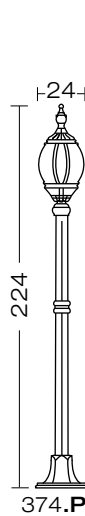
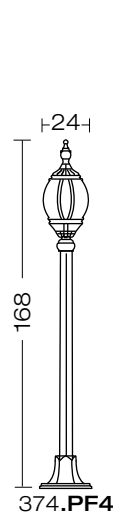

dettagli - details
- details - detalles - details:
pages 138-139

For technical details visit
www.landa.it

IP44

96°

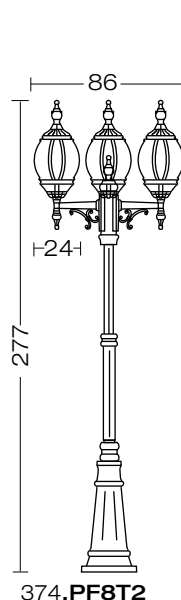
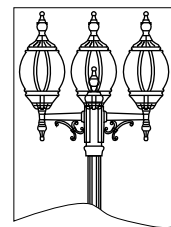
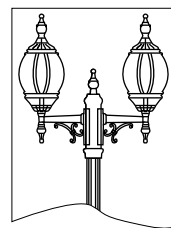
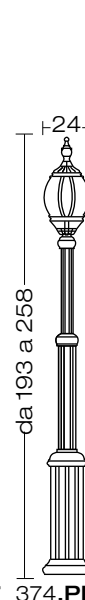
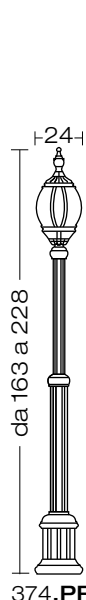

374.PF8T3

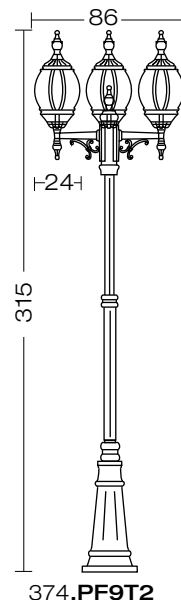

374.PF9T3

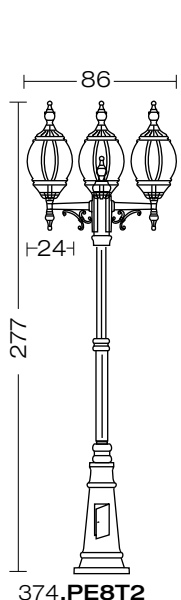

374.PE8T3

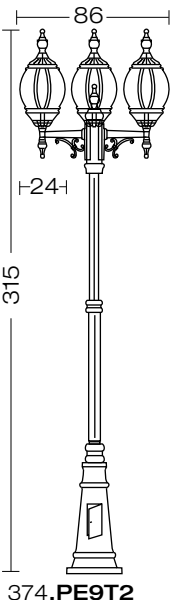

374.PE9T3

ELECTRIFICATION

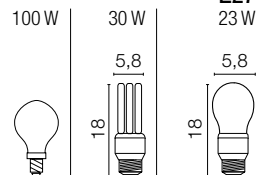

COLOURS



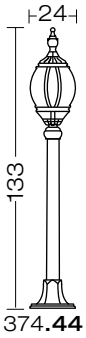

374.44

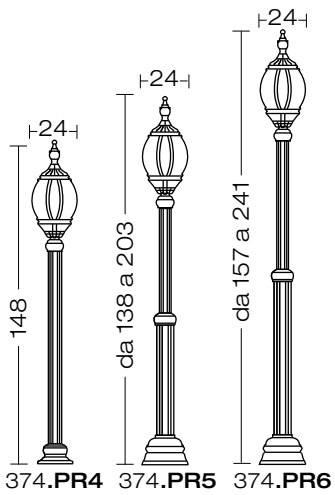

374.PR4 374.PR5 374.PR6

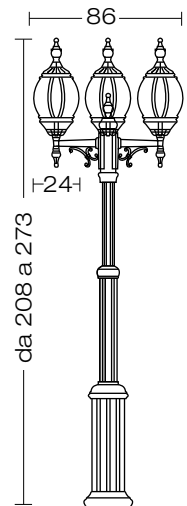

374.PR8T2
374.PR8T3

Accessories on request:



code 0404M004
Single connection IP68



code 0404M003
Loop in loop out IP68

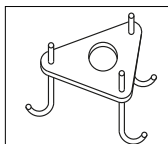

374.PF4.....
374.PF5.....
374.PF6.....

Anchor Bolt: code 00APF6

374.PF7.....
374.PF8.....
374.PF9.....

code 00APF8

374.PR5.....
374.PR6.....

code 00APR6

374.PR7.....
374.PR8.....

code 00APR8

LED

powered by
Citizen Electronics® LED
Transformer included

example code:

art.	finishing	size	LED	colour
100	.	01	L60	H ngg

example copper top code:

art.	finishing	size	LED	colour
100	A	01	L60	H ngg

art.
100

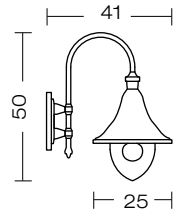

100.01L60
100.01L60H
100A01L60
100A01L60H

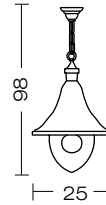

100.02L60
100.02L60H
100A02L60
100A02L60H

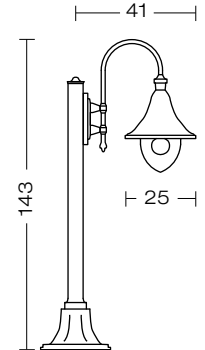

100.P1.12L60
100.P1.12L60H
100AP1.12L60
100AP1.12L60H

corpo alluminio pressofuso
body in die casting aluminium
corps en aluminium moulé
sous pression
cuerpo aluminio inyectado
Körper aus Aluminium-
Druckguss

diffusore policarbonato
frosted
diffuser frosted
polycarbonate
diffuser polycarbonate
frosted
difusor policarbonato
frosted
Diffuser Polykarbonat frosted

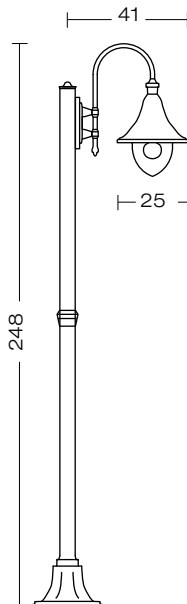

100.P1L60
100.P1L60H
100AP1L60
100AP1L60H

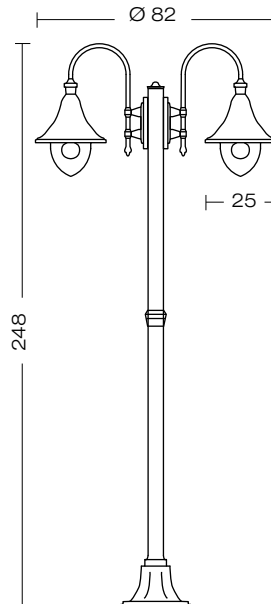

100.P2L60
100.P2L60H
100AP2L60
100AP2L60H

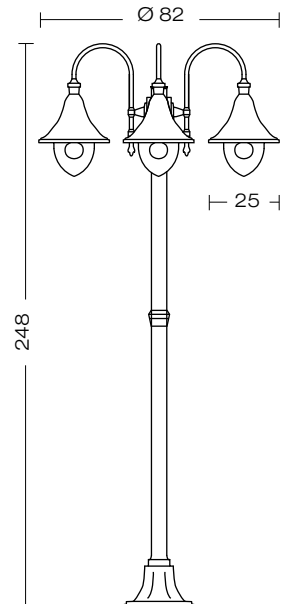

100.P3L60
100.P3L60H
100AP3L60
100AP3L60H

For technical details visit
www.landa.it

IP44

85°

TOP
FINISHING



A



code 100A....

articoli disponibili anche con
cappello in rame
the items are also available
with copper top
ces articles sont disponibles aussi
avec le chapeau en cuivre
piezas disponibles
también en cobre
Diese Artikel sind auch mit
Kupfer-Dach verfügbar

COLOURS



ngg



nga



ngv



bgg



ngr

LED

dettagli /
details / details
detalles / details:
pages 4-5

L60
LED 5 W
5000°K
430LM
Ra65



L60H
LED 5 W
2900°K
330LM
Ra85

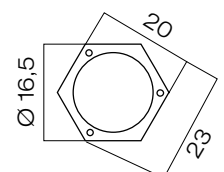

BASE DIMENSIONS



LED



Accessories on request:



code **0404M004**
Single connection IP68



code **0404M003**
Loop in loop out IP68

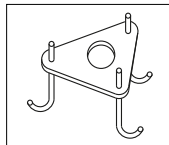

Anchor Bolt
code **00APL6**

00108
angoliera
corner bracket
patte d'angle
esquinera
Eckhalterungen

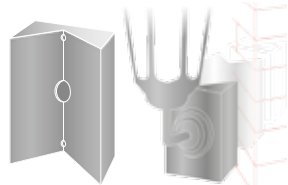

esempio di fissaggio
fixing example
exemple de fixation
ejemplo de fijación
Beispiel von Fixierung

example code:

| art. | finishing | size | colour |
100 . 01 ngr

example copper top code:
100 **A** 01 ngr

art.
100

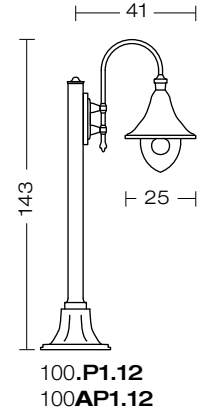
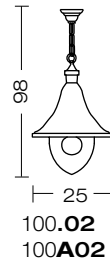
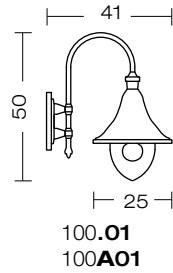

corpo alluminio pressofuso
body in die casting aluminium
corps en aluminium moulé
sous pression
cuerpo aluminio inyectado
Körper aus Aluminium-
Druckguss

diffusore policarbonato
trasparente
diffuser transparent
polycarbonate
diffuser polycarbonate
transparent
difusor policarbonato
transparente
Diffuser Polykarbonat klar

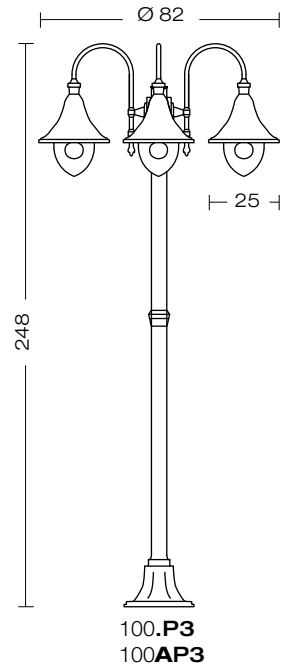
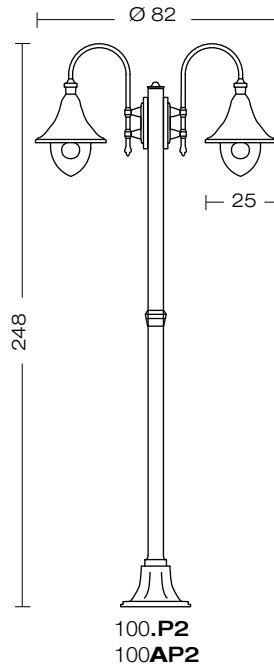
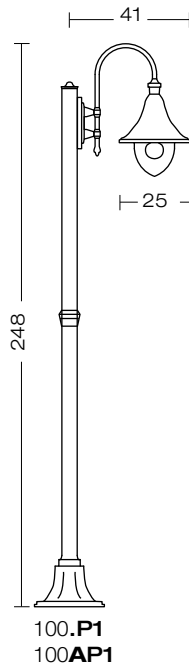

For technical details visit
www.landa.it

IP44

850°

TOP
FINISHING



code 100A....

articoli disponibili anche con
cappello in rame
the items are also available
with copper top
ces articles sont disponibles aussi
avec le chapeau en cuivre
piezas disponibles
también en cobre
Diese Artikel sind auch mit
Kupfer-Dach verfügbar

COLOURS



ELECTRIFICATION

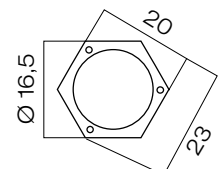
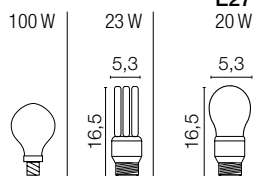

BASE DIMENSIONS



Accessories on request:



code **0404M004**
Single connection IP68



code **0404M003**
Loop in loop out IP68

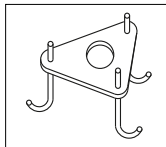

Anchor Bolt
code **00APL6**

00108
angoliera
corner bracket
patte d'angle
esquinera
Eckhalterungen

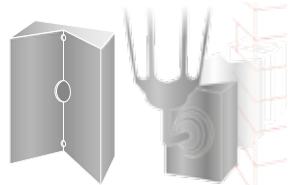

esempio di fissaggio
fixing example
exemple de fixation
ejemplo de fijación
Beispiel von Fixierung

example code:

art.	finishing	size	colour
110	.	02	ngv

example copper top code:

art.	finishing	size	colour
110	A	02	ngv

art.
110

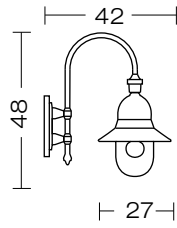

110.01
110A01

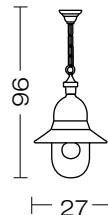

110.02
110A02

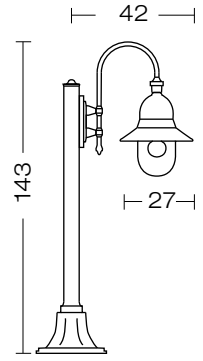

110.P1.12
110AP1.12

corpo alluminio pressofuso
body in die casting aluminium
corps en aluminium moulé
sous pression
cuerpo aluminio inyectado
Körper aus Aluminium-
Druckguss

diffusore policarbonato
trasparente
diffuser transparent
polycarbonate
diffuser polycarbonate
transparent
difusor policarbonato
transparente
Diffuser Polykarbonat klar

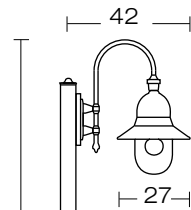

110.P1
110AP1

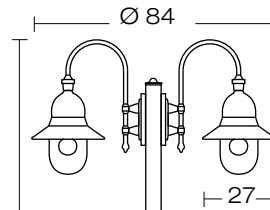

110.P2
110AP2

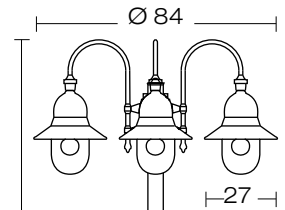

110.P3
110AP3

For technical details visit
www.landa.it

IP43

960°

TOP
FINISHING



A



code 110A....

articoli disponibili anche con
cappello in rame
the items are also available
with copper top
ces articles sont disponibles aussi
avec le chapeau en cuivre
piezas disponibles
también en cobre
Diese Artikel sind auch mit
Kupfer-Dach verfügbar

COLOURS



ngg



bgg



ngv



ngr

ELECTRIFICATION

100 W



23 W



E27

20 W

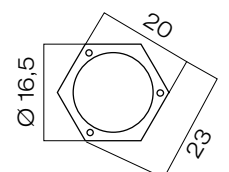
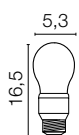

BASE DIMENSIONS



Accessories on request:



code **0404M004**
Single connection IP68



code **0404M003**
Loop in loop out IP68

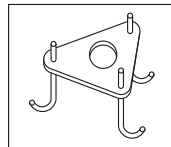

Anchor Bolt
code **00APL6**

00108
angoliera
corner bracket
patte d'angle
esquinera
Eckhalterungen

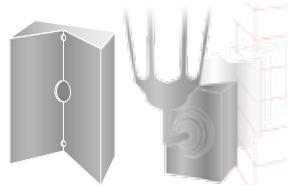

esempio di fissaggio
fixing example
exemple de fixation
ejemplo de fijación
Beispiel von Fixierung

example code:
 | art. | finishing | size | colour |
 150 . P1.12 bgg

art.
150

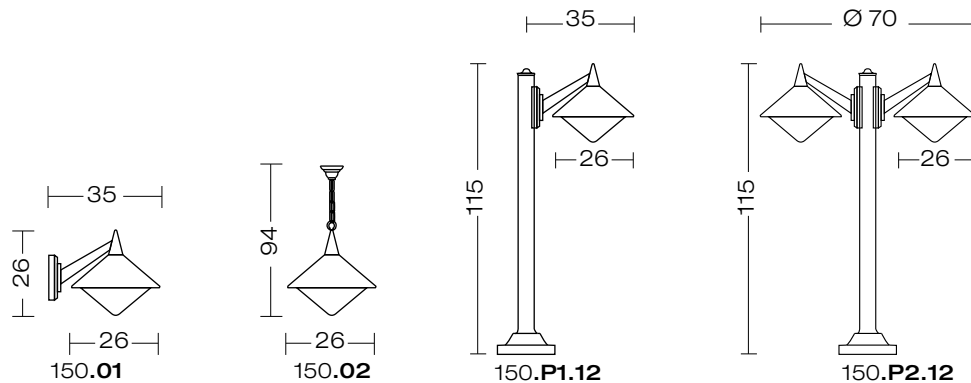

corpo alluminio pressofuso
 body in die casting aluminium
 corps en aluminium moulé
 sous pression
 cuerpo aluminio inyectado
 Körper aus Aluminium-
 Druckguss

diffusore policarbonato opale
 diffuser polycarbonate opal
 diffuser polycarbonate opale
 difusor policarbonato ópalo
 Diffuser Polykarbonat opal

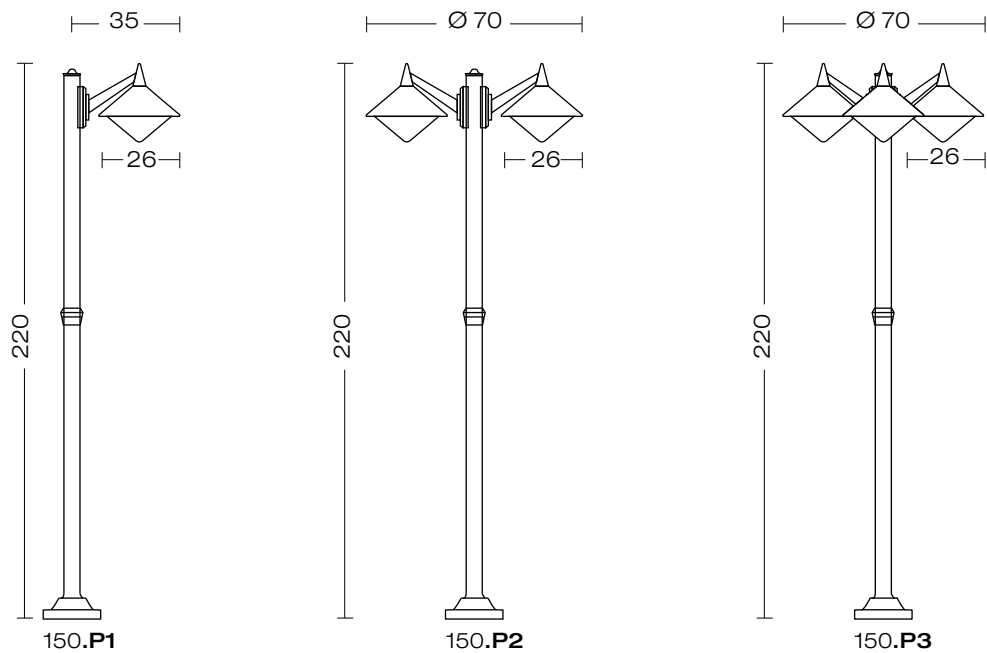

For technical details visit
www.landa.it

IP43

850°

COLOURS



ELECTRIFICATION

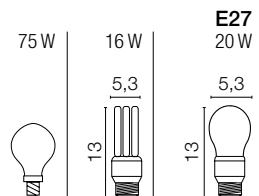

BASE DIMENSION

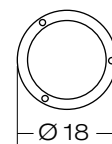



Accessories on request:

00108
angoliera
corner bracket
patte d'angle
esquinera
Eckhalterungen

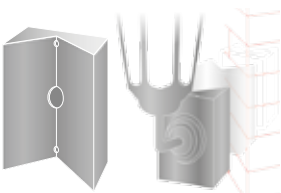

esempio di fissaggio
fixing example
exemple de fixation
ejemplo de fijación
Beispiel von Fixierung

example code:

| art. | finishing | size | colour |
165 . 02 ngr

example copper top code:

| art. | finishing | size | colour |
165 **A** 02 ngr

art.
165

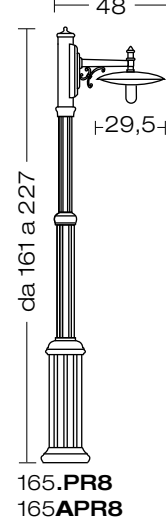
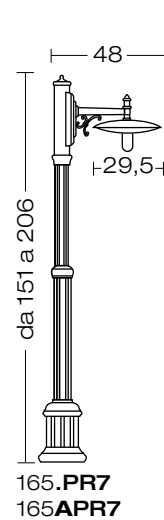
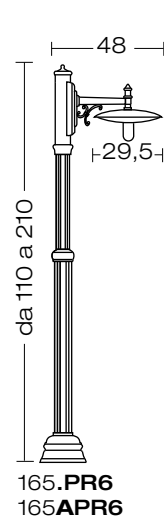
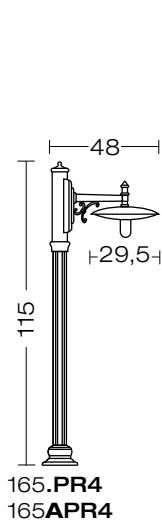
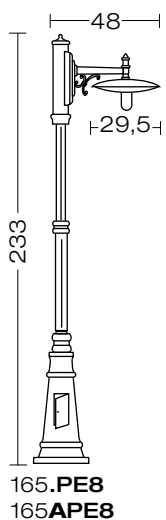
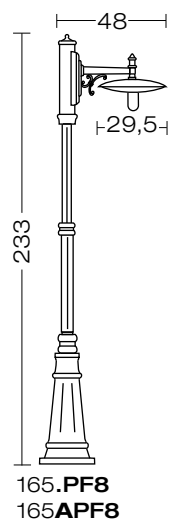
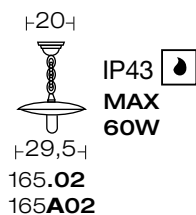
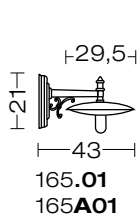

corpo alluminio pressofuso
body in die casting aluminium
corps en aluminium moulé
sous pression
cuerpo aluminio inyectado
Körper aus Aluminium-
Druckguss

diffusore vetro opale
diffuser glass opal
diffuser verre opale
difusor vidrio ópalo
Diffuser Glas opal

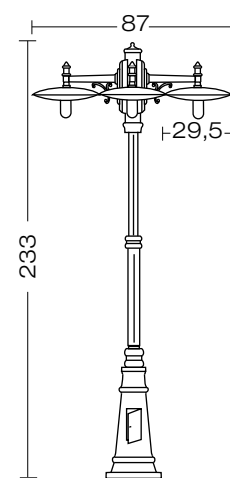
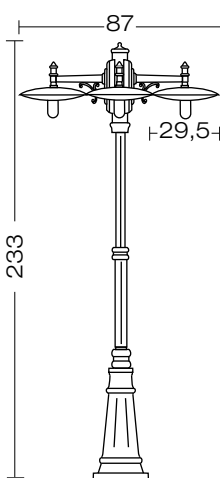
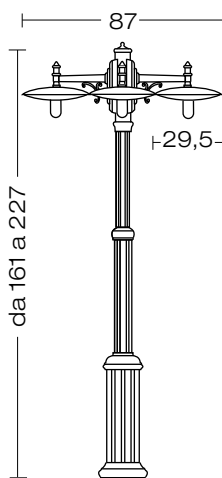
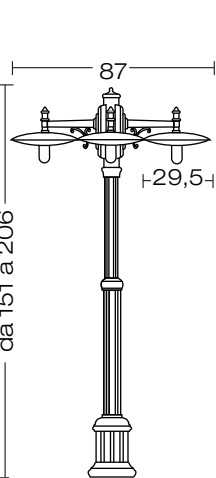
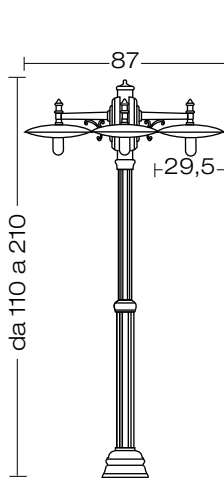

165.PF8T3
165APF8T3

165.PR7T3
165APR7T3

165.PR8T3
165APR8T3

165.PE8T3
165APE8T3

165.PE8T3
165APE8T3

For technical details visit
www.landa.it

IP44

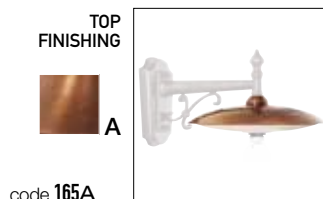

articoli disponibili anche con
cappello in rame
the items are also available
with copper top
ces articles sont disponibles aussi
avec le chapeau en cuivre
piezas disponibles
también en cobre
Diese Artikel sind auch mit
Kupfer-Dach verfügbar

COLOURS



ELECTRIFICATION

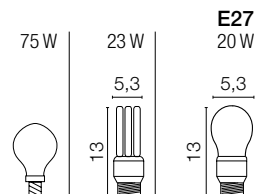

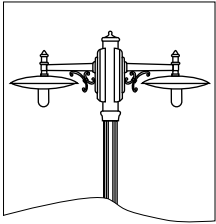

165.....T2

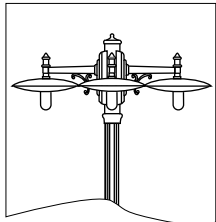

165.....T3



Accessories on request:



code 0404M004
Single connection IP68



code 0404M003
Loop in loop out IP68

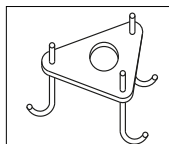

Anchor Bolt:

165.PF8.....
165.PE8.....

code 00APF8

165.PR6.....

code 00APR6

165.PR7.....
165.PR8.....

code 00APR8

example code:

| art. | finishing | size | colour |
160 . PF8 ngr

example copper top code:

| art. | finishing | size | colour |
160 **A** PF8 ngr

art.
160

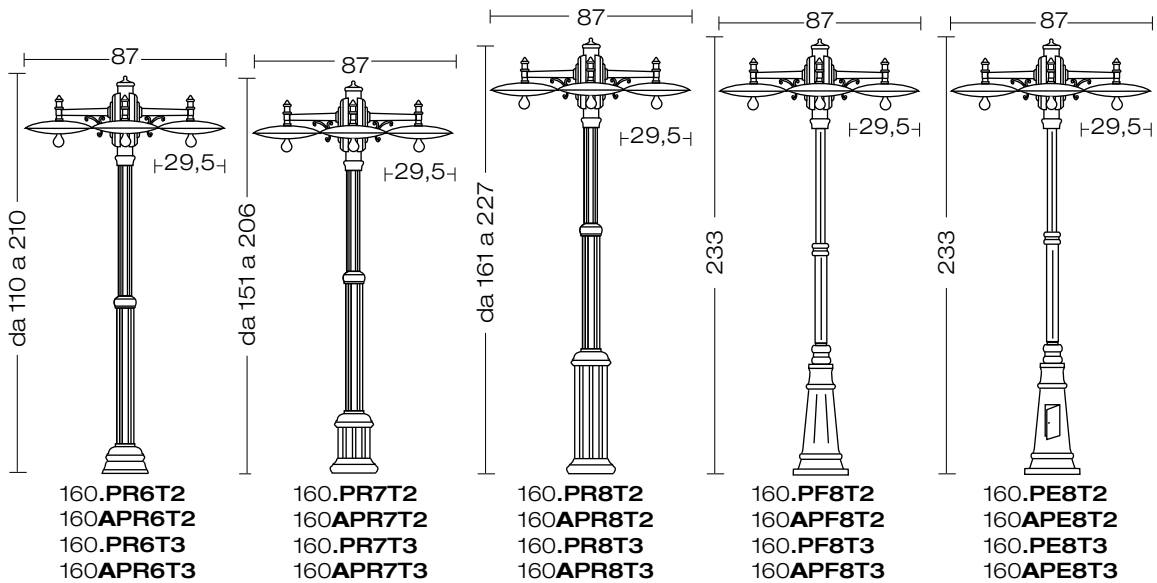
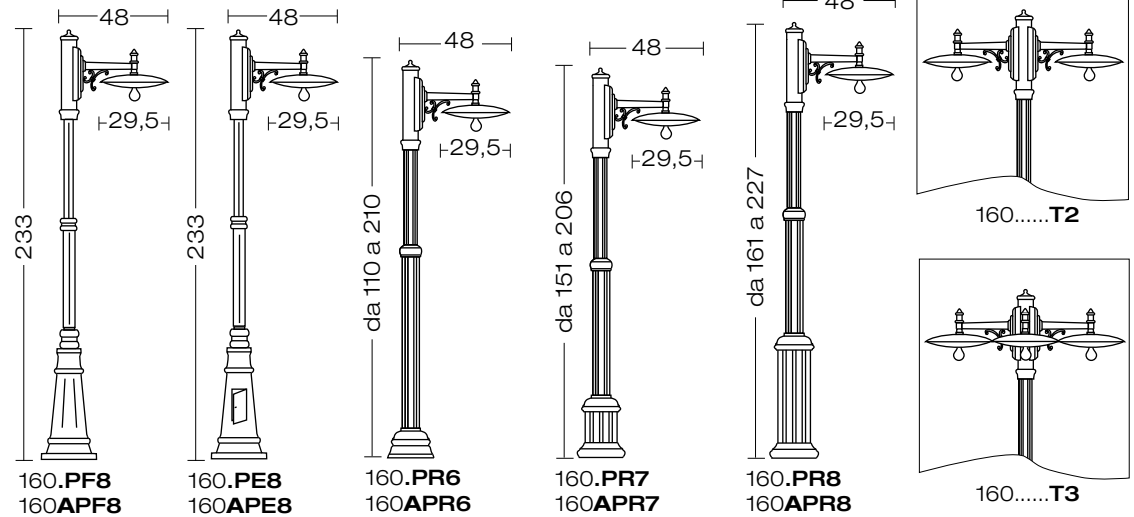
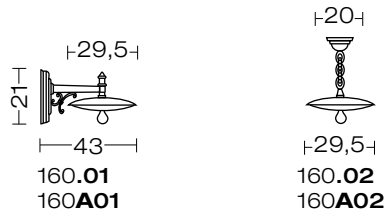

corpo alluminio pressofuso
body in die casting aluminium
corps en aluminium moulé
sous pression
cuerpo aluminio inyectado
Körper aus Aluminium-
Druckguss

dettagli - details
- details - detalles - details:
pages 138-139

For technical details visit
www.landa.it

IP23

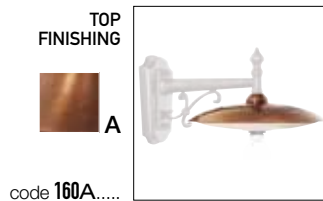

code 160A....

articoli disponibili anche con
cappello in rame
the items are also available
with copper top
ces articles sont disponibles aussi
avec le chapeau en cuivre
piezas disponibles
también en cobre
Diese Artikel sind auch mit
Kupfer-Dach verfügbar

COLOURS

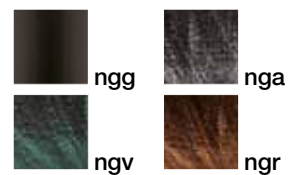

ELECTRIFICATION

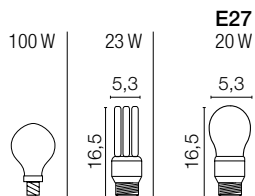



Accessories on request:



code **0404M004**
Single connection IP68



code **0404M003**
Loop in loop out IP68

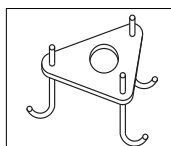

Anchor Bolt:

160.PF8.....
160.PE8.....

code **00APF8**

160.PR6.....

code **00APR6**

160.PR7.....
160.PR8.....

code **00APR8**

venezia mini

example code:
| art. | finishing | size | colour |
310 . 00 bgg

art.
310

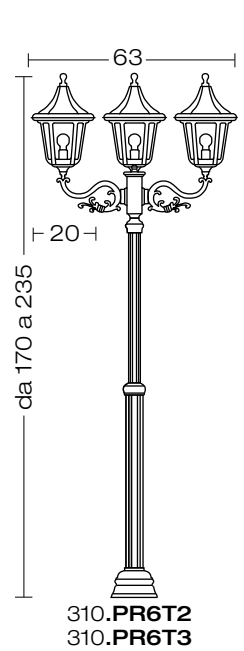
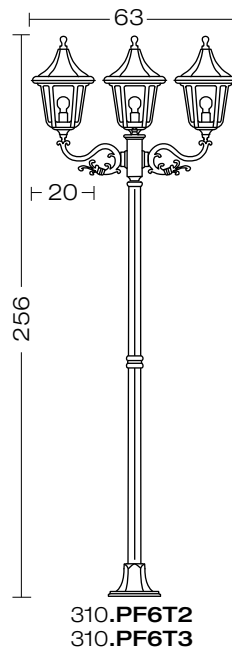
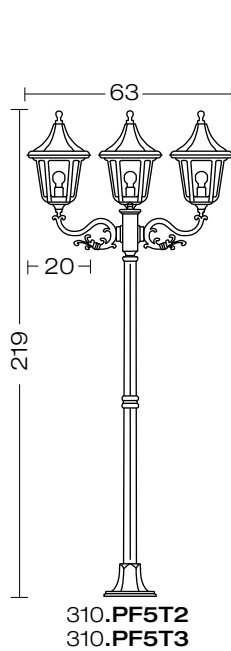
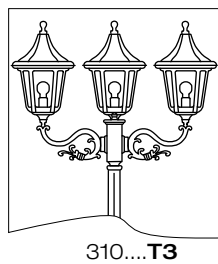
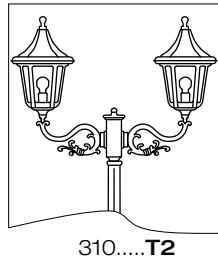
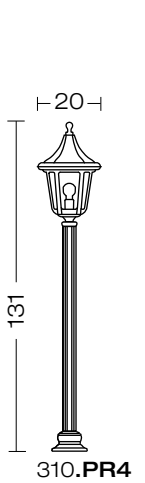
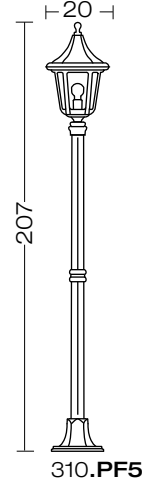
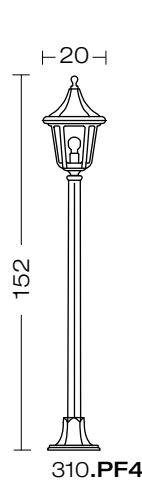
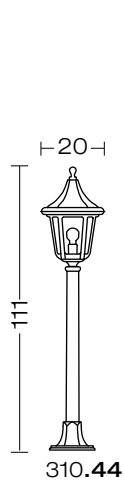
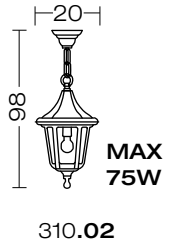
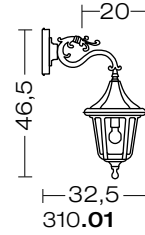
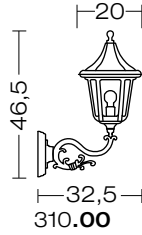
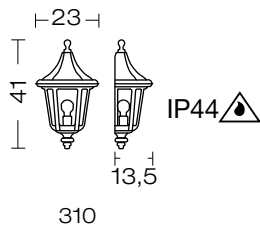

corpo alluminio pressofuso
body in die casting aluminium
corps en aluminium moulé
sous pression
cuerpo aluminio inyectado
Körper aus Aluminium-
Druckguss

diffusore policarbonato
trasparente
diffuser transparent
polycarbonate
diffuser polycarbonate
transparent
difusor policarbonato
transparente
Diffuser Polykarbonat klar

dettagli - details
- details - detalles - details:
pages 138-139

For technical details visit
www.landa.it

IP43



960°



COLOURS



ngg



bgg



ngv



ngr

ELECTRIFICATION

100 W



23 W



E27

20 W

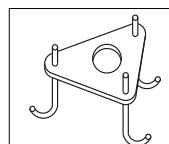

Anchor Bolt:

310.PF4....
310.PF5....
310.PF6....

310.PR5....
310.PR6....

310.PR7....

code 00APF6

code 00APR6

code 00APR8

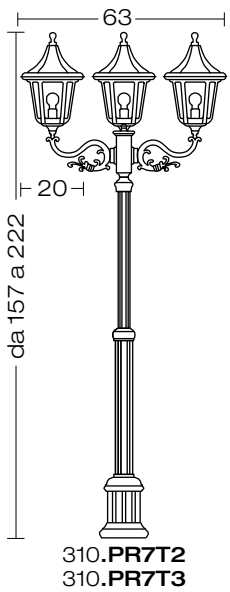
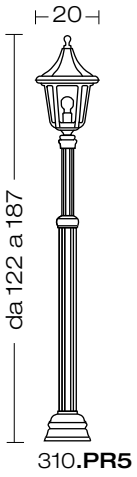

Accessories on request:



code 0404M004
Single connection IP68



code 0404M003
Loop in loop out IP68

00108
angoliera
corner bracket
patte d'angle
esquinera
Eckhalterungen

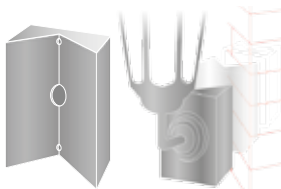

esempio di fissaggio
fixing example
exemple de fixation
ejemplo de fijación
Beispiel von Fixierung

example code:

art.	finishing	size	colour
312	.	PF4	ngv

art.
311-312

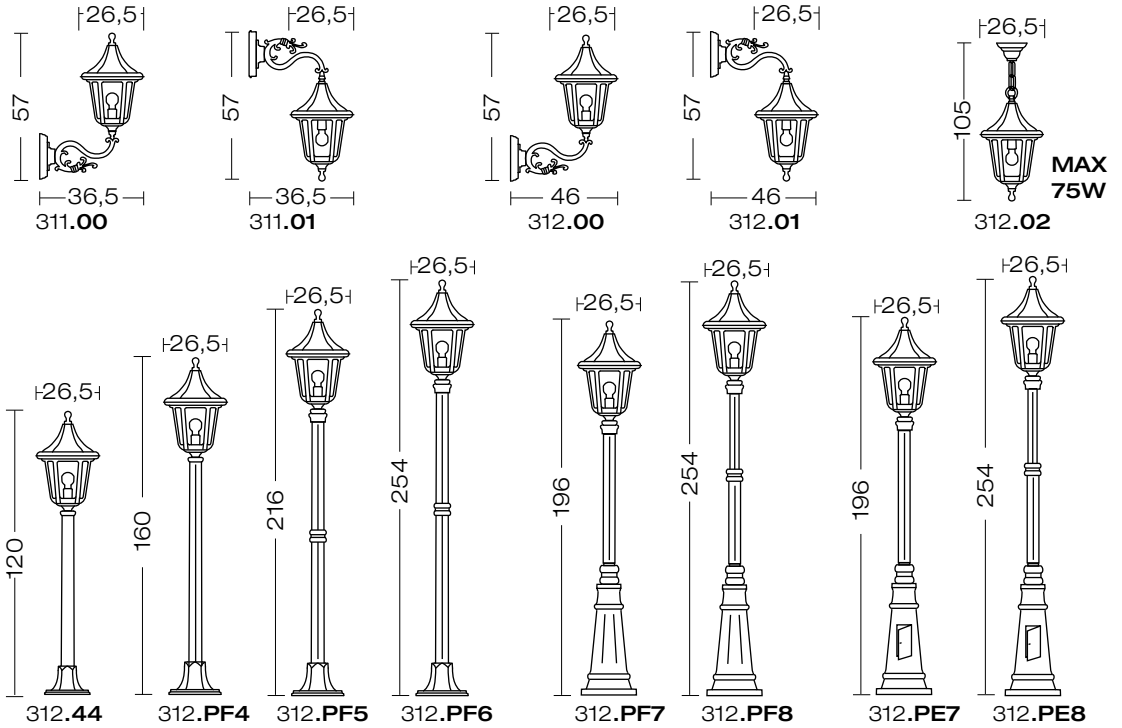

corpo alluminio pressofuso
body in die casting aluminium
corps en aluminium moulé
sous pression
cuerpo aluminio inyectado
Körper aus Aluminium-
Druckguss

diffusore policarbonato
trasparente
diffuser transparent
polycarbonate
diffuser polycarbonate
transparent
difusor policarbonato
transparente
Diffuser Polykarbonat klar

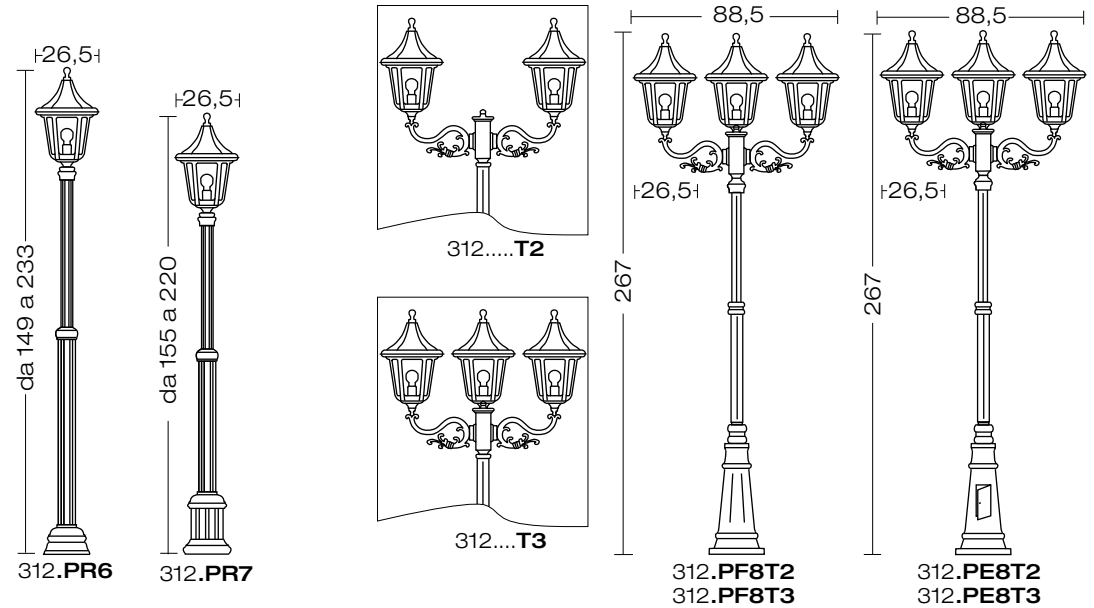

dettagli - details
- details - detalles - details:
pages 138-139

For technical details visit
www.landa.it

IP43

960°

COLOURS

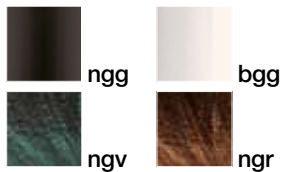

ELECTRIFICATION

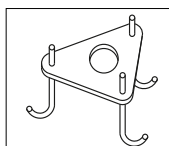
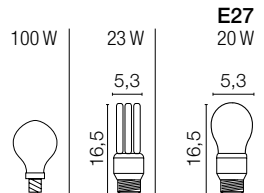

Anchor Bolt: code 00APF6

312.PF7....
312.PF8....
312.PE7....
312.PE8....

312.PR5....
312.PR6....

312.PR7....
312.PR8....

code 00APF8

code 00APR6

code 00APR8

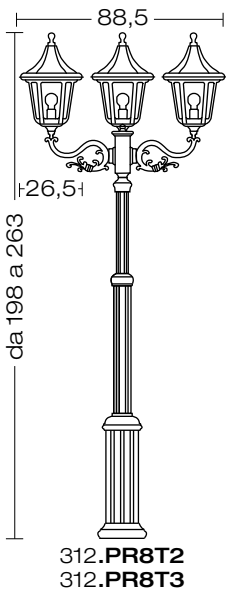
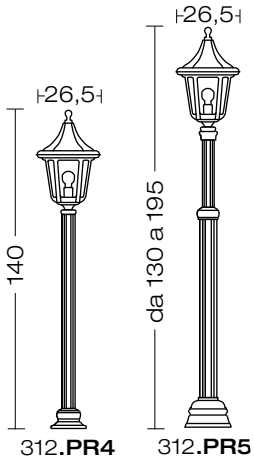
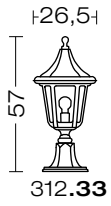

Accessories on request:



code 0404M004
Single connection IP68



code 0404M003
Loop in loop out IP68

00108
angoliera
corner bracket
patte d'angle
esquinera
Eckhalterungen

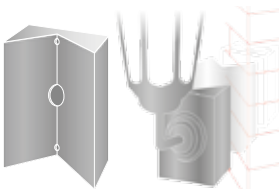

esempio di fissaggio
fixing example
exemple de fixation
ejemplo de fijación
Beispiel von Fixierung



serie/series

amalfi mini

example code:
| art. | finishing | size | colour |
320 . 00 ngg

art.
320

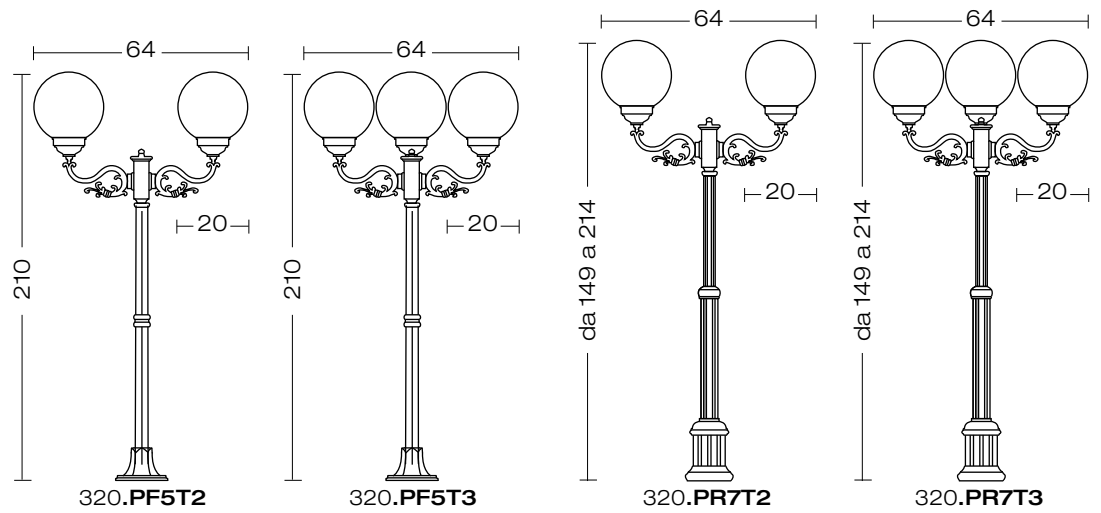
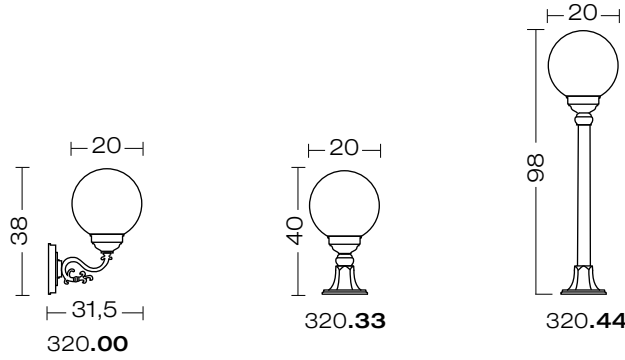

corpo alluminio pressofuso
body in die casting aluminium
corps en aluminium moulé
sous pression
cuerpo aluminio inyectado
Körper aus Aluminium-
Druckguss

diffusore PMMA opale
diffuser PMMA opal
diffuser PMMA opale
difusor PMMA ópalo
Diffuser PMMA opal

dettagli - details
- details - detalles - details:
pages 138-139

For technical details visit
www.landa.it

IP43

COLOURS

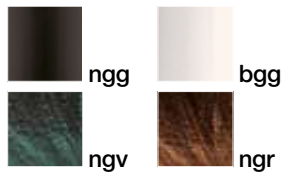

ELECTRIFICATION

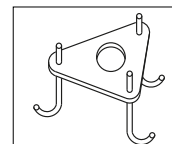
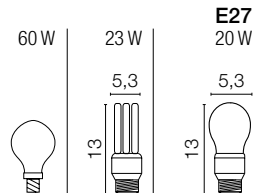

Anchor Bolt: code 00APF6 code 00APR8



Accessories on request:



code **0404M004**
Single connection IP68



code **0404M003**
Loop in loop out IP68

00108
angoliera
corner bracket
patte d'angle
esquinera
Eckhalterungen

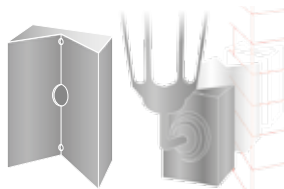

esempio di fissaggio
fixing example
exemple de fixation
ejemplo de fijación
Beispiel von Fixierung

example code:

art.	finishing	size	colour
322	.	00	bgg

art. 321-322

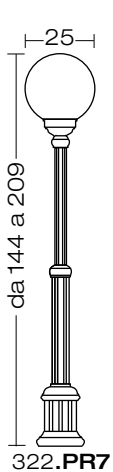
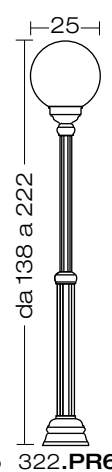
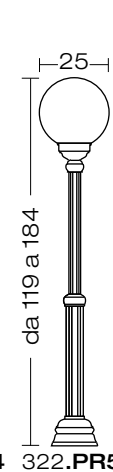
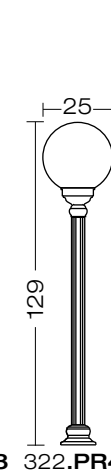
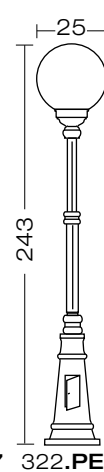
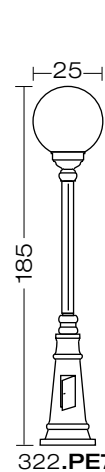
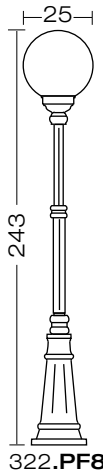
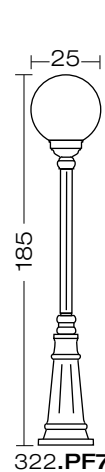
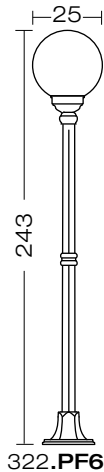
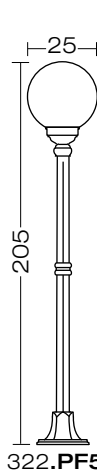
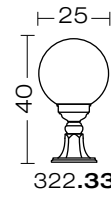
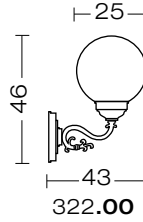
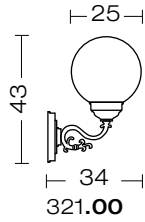

corpo alluminio pressofuso
body in die casting aluminium
corps en aluminium moulé
sous pression
cuerpo aluminio inyectado
Körper aus Aluminium-
Druckguss

diffusore PMMA opale
diffuser PMMA opal
diffuser PMMA opale
difusor PMMA ópalo
Diffuser PMMA opal

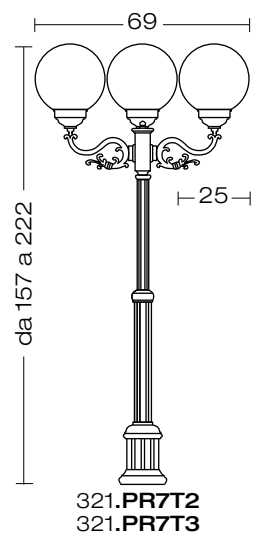
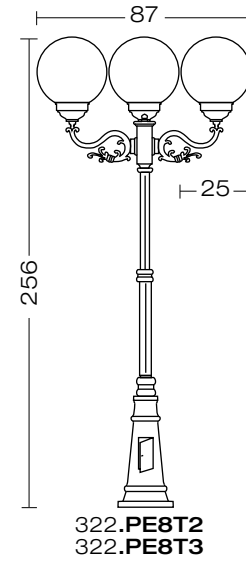
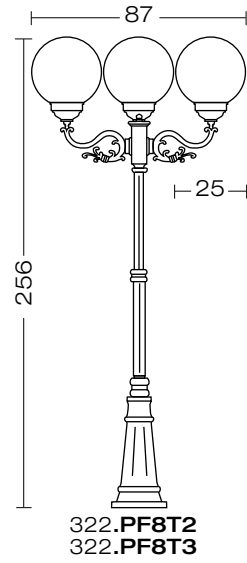
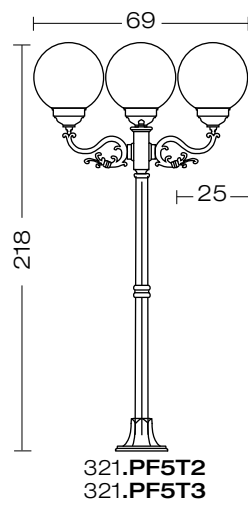

dettagli - details
- details - detalles - details:
pages 138-139

For technical details visit
www.landa.it

IP43

COLOURS

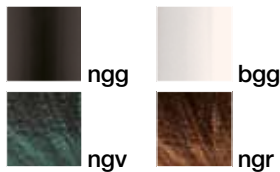

ELECTRIFICATION

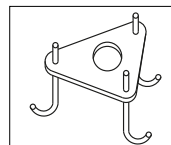
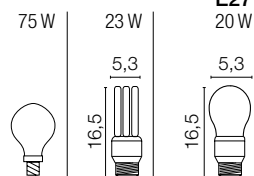

322.PF4....
322.PF5....
322.PF6....

322.PF7....
322.PF8....
322.PE7....
322.PE8....

322.PR5....
322.PR6....

322.PR7....
322.PR8....

Anchor Bolt: code 00APF6

code 00APF8

code 00APR6

code 00APR8

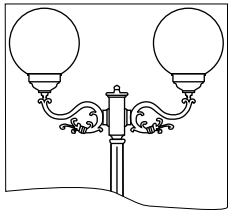
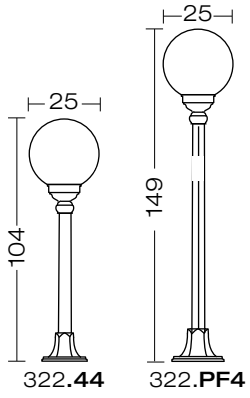

322.....T2

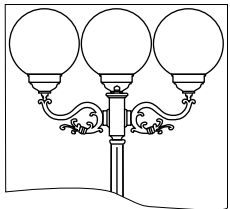

322.....T3

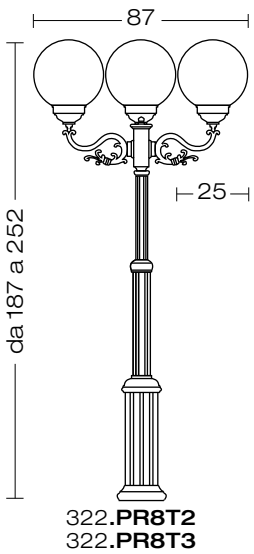

Accessories on request:



code **0404M004**
Single connection IP68



code **0404M003**
Loop in loop out IP68

00108
angoliera
corner bracket
patte d'angle
esquinera
Eckhalterungen

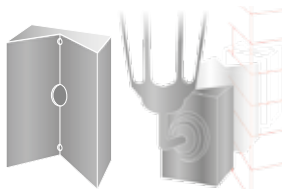

esempio di fissaggio
fixing example
exemple de fixation
ejemplo de fijación
Beispiel von Fixierung

amalfi maxi

example code:

art.	finishing	size	colour
323	.	33	ngv

art.
323

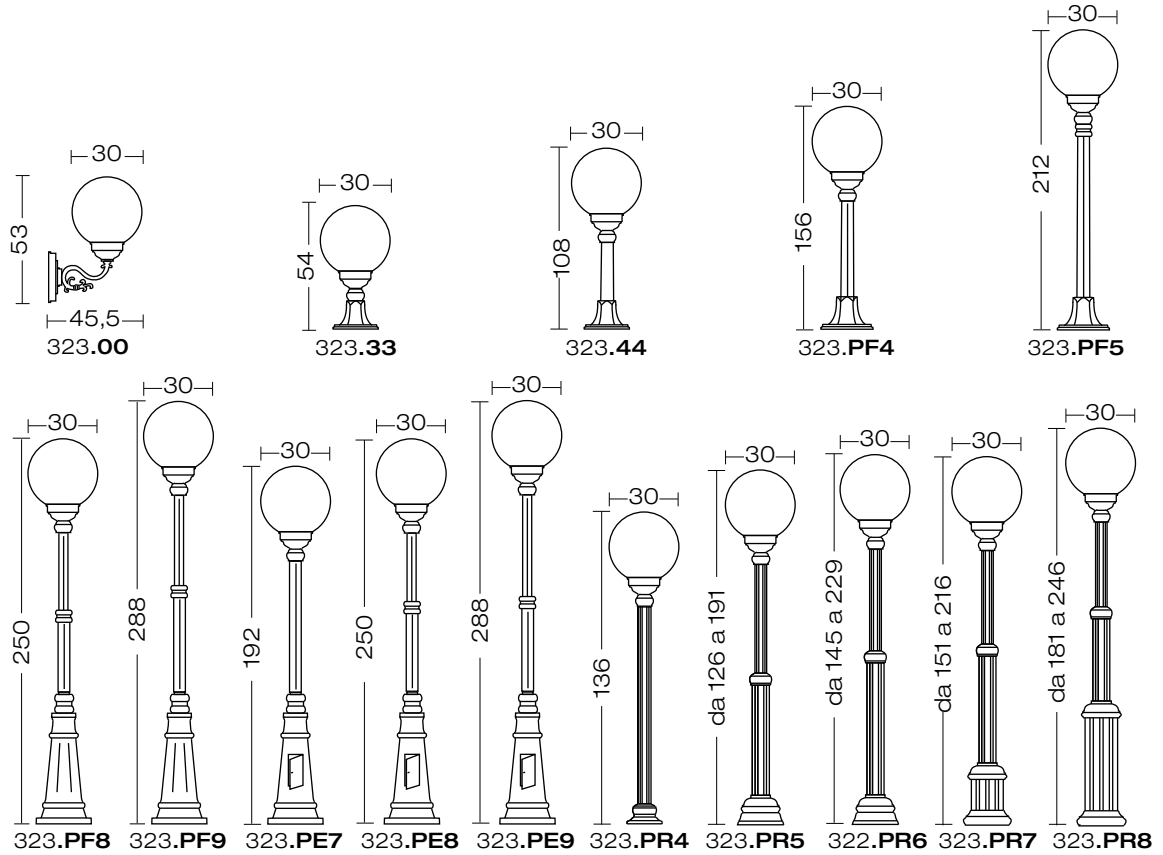

corpo alluminio pressofuso
body in die casting aluminium
corps en aluminium moulé
sous pression
cuerpo aluminio inyectado
Körper aus Aluminium-
Druckguss

diffusore PMMA opale
diffuser PMMA opal
diffuser PMMA opale
difusor PMMA ópalo
Diffuser PMMA opal

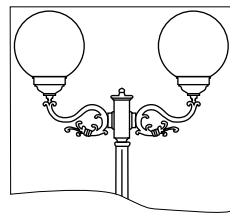

323.....T2

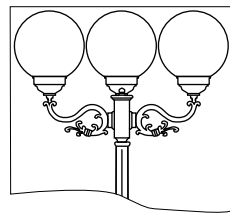

323.....T3

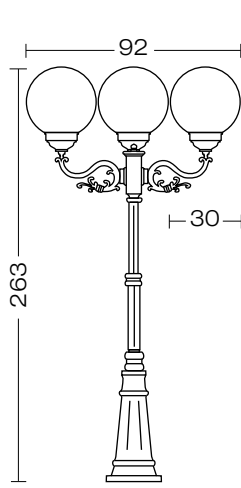

323.PF8T2
323.PF8T3

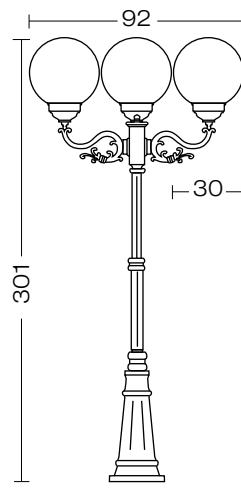

323.PF9T2
323.PF9T3

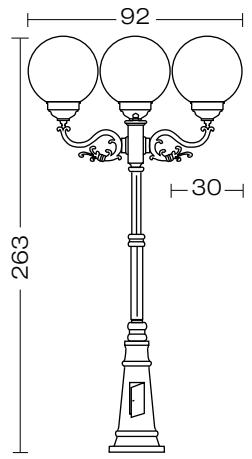

323.PE8T2
323.PE8T3

dettagli - details
- details - detalles - details:
pages 138-139

For technical details visit
www.landa.it

IP43

COLOURS

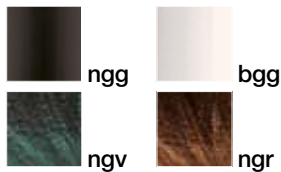

ELECTRIFICATION

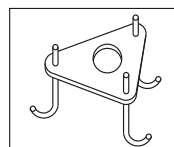
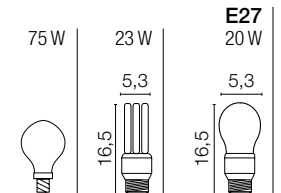

323.PF4....
323.PF5....
323.PF6....

Anchor Bolt: code 00APF6

323.PF7....
323.PF8....
323.PF9....
323.PE7....
323.PE8....
323.PE9....

code 00APF8

323.PR5....
323.PR6....

code 00APR6

323.PR7....
323.PR8....

code 00APR8

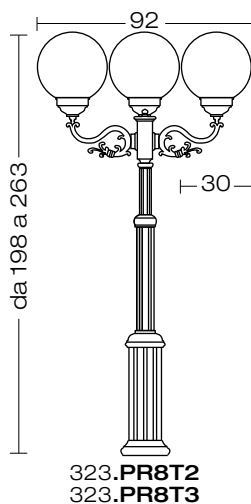
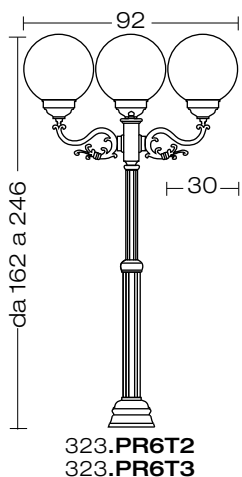
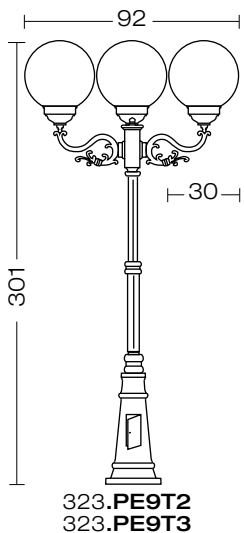
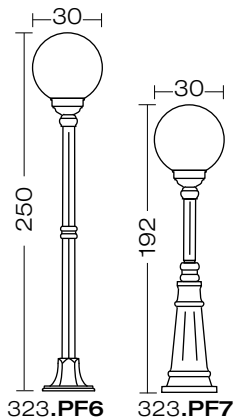

Accessories on request:



code **0404M004**
Single connection IP68



code **0404M003**
Loop in loop out IP68

00108
angoliera
corner bracket
patte d'angle
esquinera
Eckhalterungen

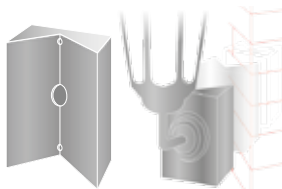

esempio di fissaggio
fixing example
exemple de fixation
ejemplo de fijación
Beispiel von Fixierung

example code:

art.	finishing	size	colour
330	.	33	nga

example copper top code:

art.	finishing	size	colour
330	A	33	nga

art.
330

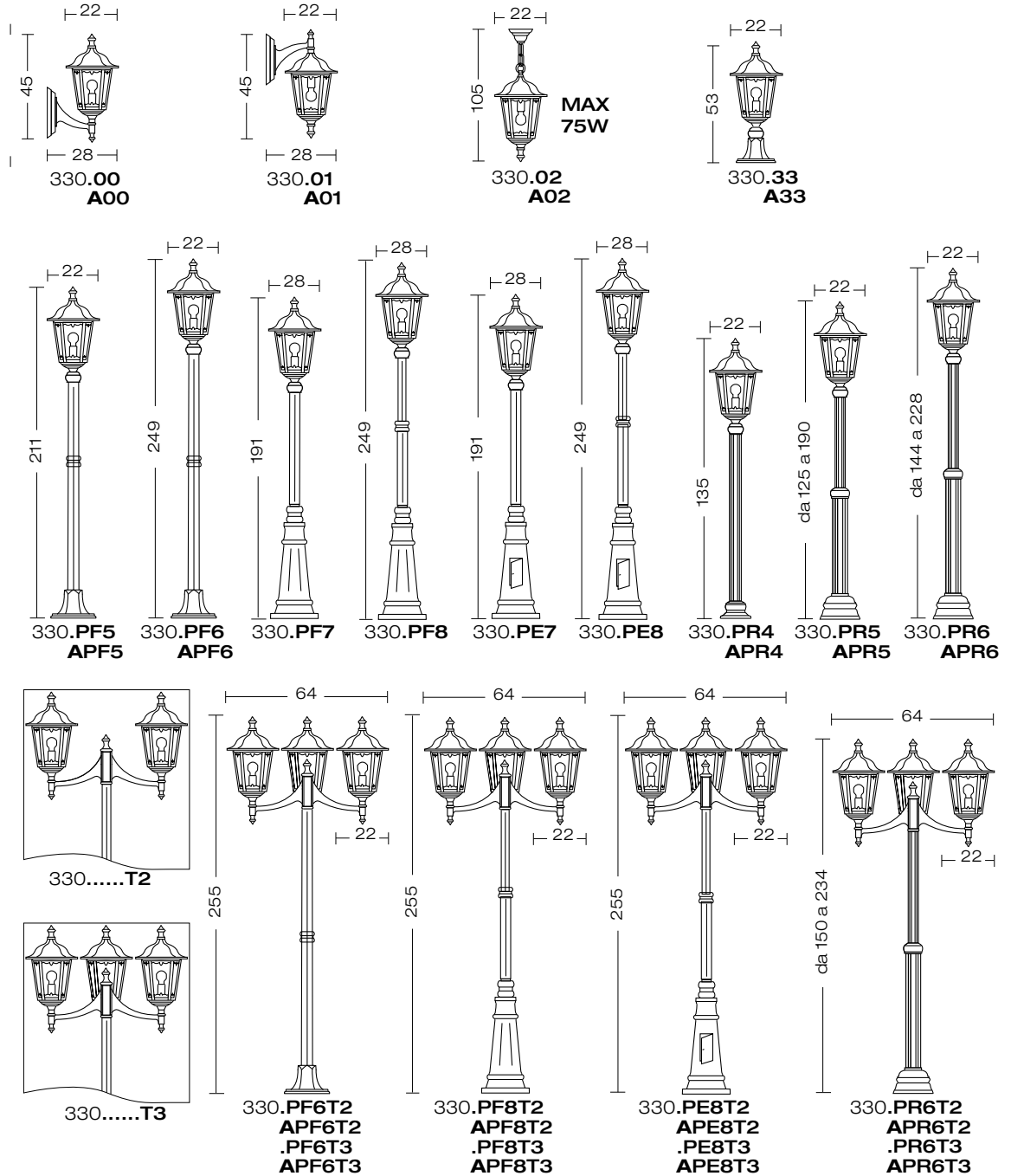

corpo alluminio pressofuso
body in die casting aluminium
corps en aluminium moulé
sous pression
cuerpo aluminio inyectado
Körper aus Aluminium-
Druckguss

diffusore vetro
diffuser glass
diffuser verre
difusor vidrio
Diffuser Glas

dettagli - details
- details - detalles - details:
pages 138-139

For technical details visit
www.landa.it

IP43

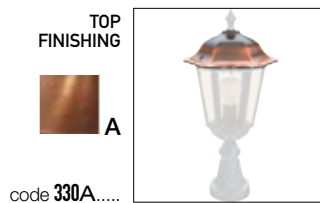

articoli disponibili anche con
cappello in rame
the items are also available
with copper top
ces articles sont disponibles aussi
avec le chapeau en cuivre
piezas disponibles
también en cobre
Diese Artikel sind auch mit
Kupfer-Dach verfügbar

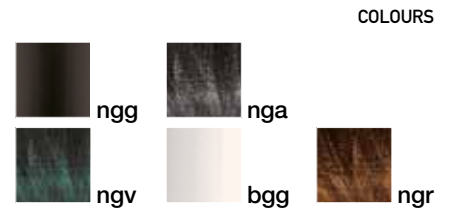

ELECTRIFICATION

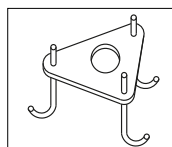
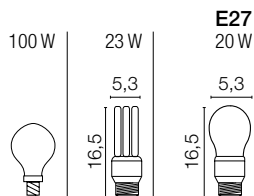

330.PF4.....
330.PF5.....
330.PF6.....

330.PF7.....
330.PF8.....
330.PE7.....
330.PE8.....

330.PR5.....
330.PR6.....

330.PR7.....
330.PR8.....

Anchor Bolt: code 00APF6

code 00APF8

code 00APR6

code 00APR8

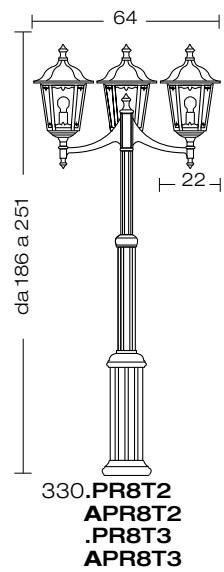
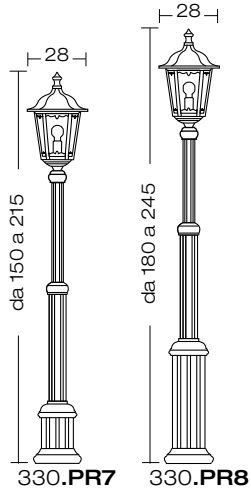
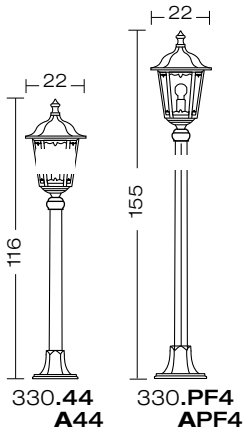

Accessories on request:



code 0404M004
Single connection IP68



code 0404M003
Loop in loop out IP68

00108
angoliera
corner bracket
patte d'angle
esquinera
Eckhalterungen

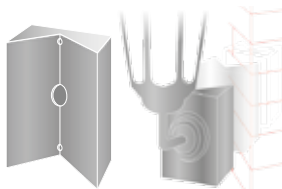

esempio di fissaggio
fixing example
exemple de fixation
ejemplo de fijación
Beispiel von Fixierung

example code:

art.	finishing	size	colour
340	.	00	nga

example copper top code:

art.	finishing	size	colour
340	A	00	nga

art.
340

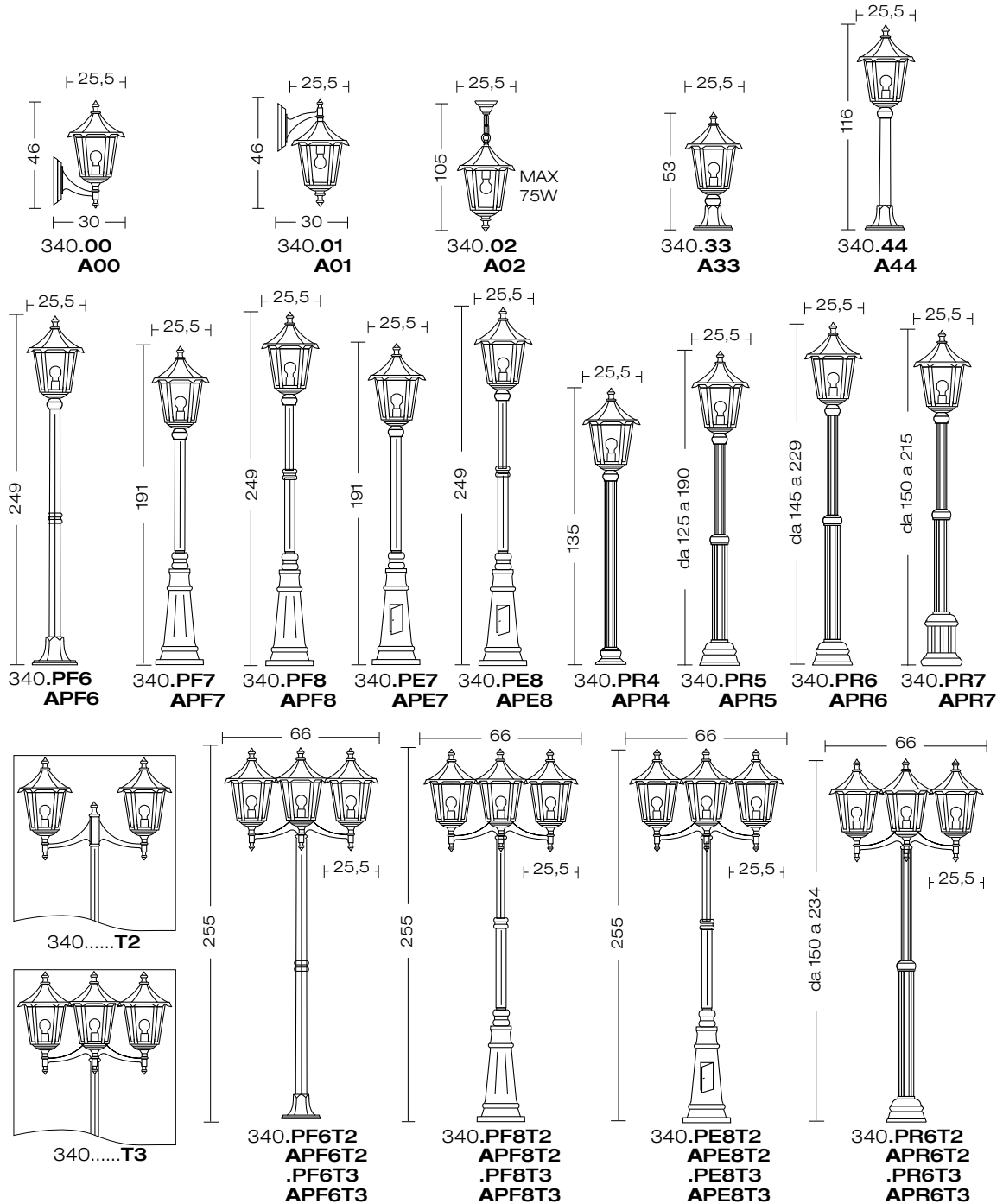

corpo alluminio pressofuso
body in die casting aluminium
corps en aluminium moulé
sous pression
cuerpo aluminio inyectado
Körper aus Aluminium-
Druckguss

diffusore vetro
diffuser glass
diffuser verre
difusor vidrio
Diffuser Glas

dettagli - details
- details - detalles - details:
pages 138-139

For technical details visit
www.landa.it

IP43



articoli disponibili anche con
cappello in rame
the items are also available
with copper top
ces articles sont disponibles aussi
avec le chapeau en cuivre
piezas disponibles
también en cobre
Diese Artikel sind auch mit
Kupfer-Dach verfügbar

COLOURS

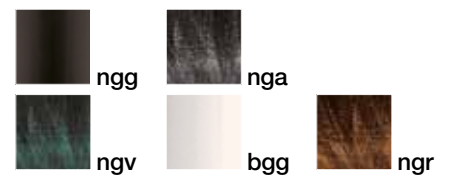

ELECTRIFICATION

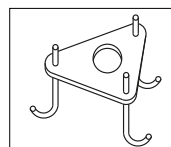
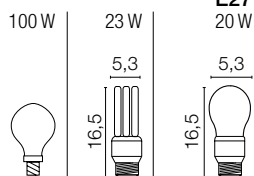

340.PF4....
340.PF5....
340.PF6....

340.PF7....
340.PF8....
340.PE7....
340.PE8....

340.PR5....
340.PR6....

340.PR7....
340.PR8....

Anchor Bolt: code 00APF6

code 00APF8

code 00APR6

code 00APR8

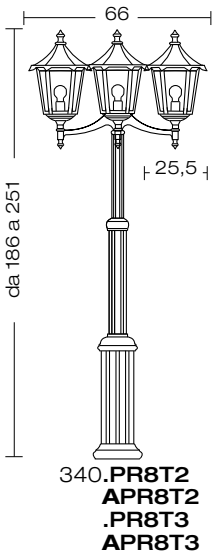
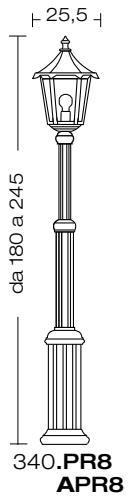
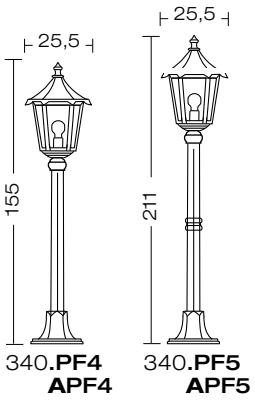

Accessories on request:



code 0404M004
Single connection IP68



code 0404M003
Loop in loop out IP68

00108
angoliera
corner bracket
patte d'angle
esquinera
Eckhalterungen

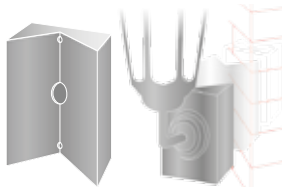

esempio di fissaggio
fixing example
exemple de fixation
ejemplo de fijación
Beispiel von Fixierung

LED

powered by
Citizen Electronics® LED
Transformer included

example code:

art.	finishing	size	LED	colour
350	.	01	L10	H ngg

example copper top code:

art.	finishing	size	LED	colour
350	A	01	L5	H ngg

art.
350

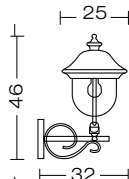

350.**00L5**
.00L5H
.00L10
.00L10H
350A...

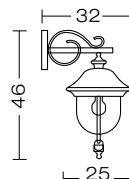

350.**01L5**
.01L5H
.01L10
.01L10H
350A...

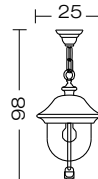

350.**02L5**
.02L5H
.02L10
.02L10H
350A...

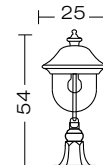

350.**33L5**
.33L5H
.33L10
.33L10H
350A...

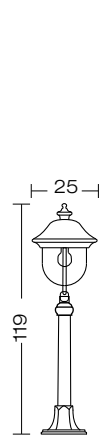

350.**44L5**
.44L5H
.44L10
.44L10H
350A...

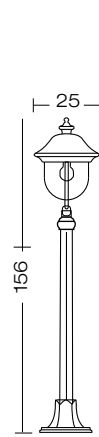

350.**PF4L5**
.PF4L5H
.PF4L10
.PF4L10H
350A...

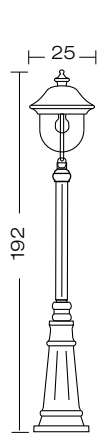

350.**PF7L5**
.PF7L5H
.PF7L10
.PF7L10H
350A...

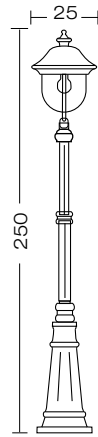

350.**PF8L5**
.PF8L5H
.PF8L10
.PF8L10H
350A...

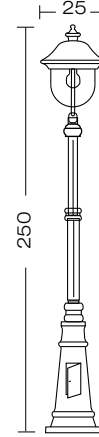

350.**PE8L5**
.PE8L5H
.PE8L10
.PE8L10H
350A...

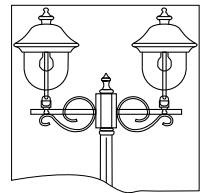

350.....T2.....

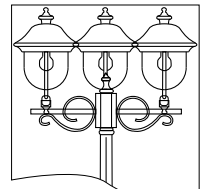

350.....T3.....

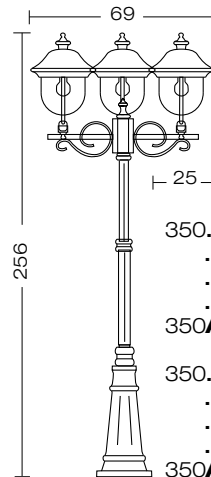

350.**PF8T2L5**
.PF8T2L5H
.PF8T2L10
.PF8T2L10H
350A...
350.**PF8T3L5**
.PF8T3L5H
.PF8T3L10
.PF8T3L10H
350A...

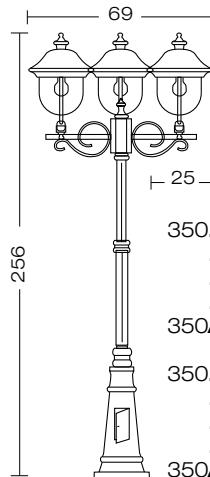

350.**PE8T2L5**
.PE8T2L5H
.PE8T2L10
.PE8T2L10H
350A...
350.**PE8T3L5**
.PE8T3L5H
.PE8T3L10
.PE8T3L10H
350A...

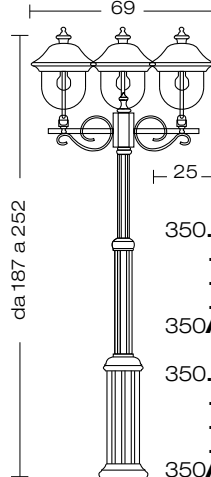

350.**PR8T2L5**
.PR8T2L5H
.PR8T2L10
.PR8T2L10H
350A...
350.**PR8T3L5**
.PR8T3L5H
.PR8T3L10
.PR8T3L10H
350A...

350A..... = copper top version

corpo alluminio pressofuso
body in die casting aluminium
corps en aluminium moulé
sous pression
cuerpo aluminio inyectado
Körper aus Aluminium-
Druckguss

diffusore policarbonato frosted
diffuser frosted polycarbonate
diffuser polycarbonate frosted
difusor policarbonato frosted
Diffuser Polykarbonat frosted

dettagli - details
- details - detalles - details:
pages 138-139

For technical details visit
www.landa.it

IP43

960°

TOP FINISHING



code 350A.....



articoli disponibili anche con
cappello in rame
the items are also available
with copper top
ces articles sont disponibles aussi
avec le chapeau en cuivre
piezas disponibles
también en cobre
Diese Artikel sind auch mit
Kupfer-Dach verfügbar

COLOURS



ngg



nga



ngv



bgg



ngr

LED

dettagli /
details / details
detalles / details:
pages 4-5

L5
LED 5 W
5000°K
430LM
Ra65



L5H
LED 5 W
2900°K
330LM
Ra85



L10
LED 10 W
5000°K
910LM
Ra65



L10H
LED 10 W
2900°K
680LM
Ra85

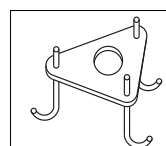

350.PF4.....

Anchor Bolt: code 00APF6

350.PF7.....
350.PF8.....
350.PE7.....
350.PE8.....

code 00APF8

350.PR8.....

code 00APR8



LED



Accessories on request:



code **0404M004**
Single connection IP68



code **0404M003**
Loop in loop out IP68

00108
angoliera
corner bracket
patte d'angle
esquinera
Eckhalterungen

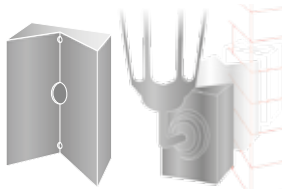

esempio di fissaggio
fixing example
exemple de fixation
ejemplo de fijación
Beispiel von Fixierung

example code:

art.	finishing	size	colour
350	.	33	ngv

example copper top code:

art.	finishing	size	colour
350	A	33	ngv

art.
350

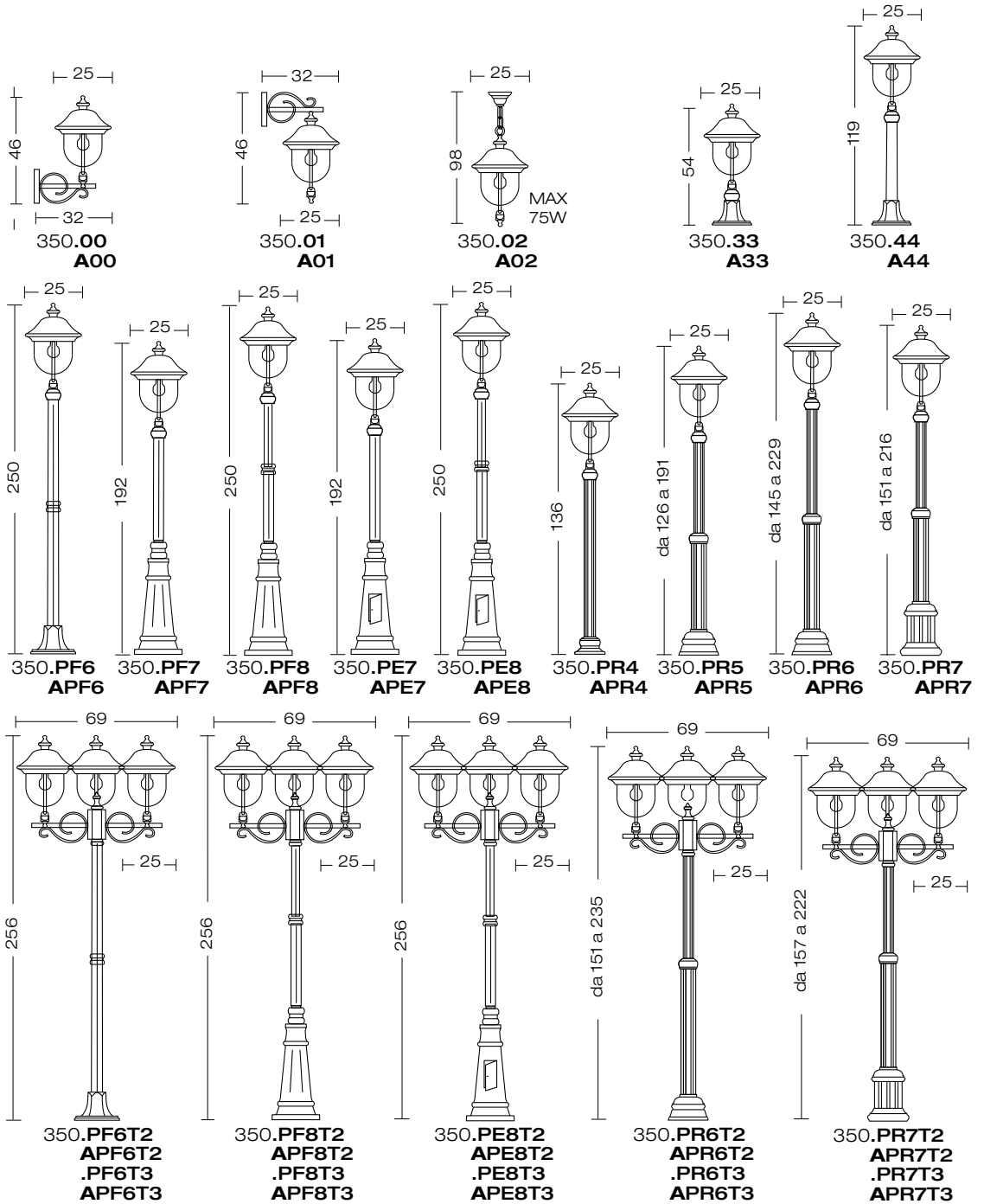

corpo alluminio pressofuso
body in die casting aluminium
corps en aluminium moulé
sous pression
cuerpo aluminio inyectado
Körper aus Aluminium-
Druckguss

diffusore policarbonato
trasparente
diffuser transparent
polycarbonate
diffuser polycarbonate
transparent
difusor policarbonato
transparente
Diffuser Polykarbonat klar

dettagli - details
- details - detalles - details:
pages 138-139

For technical details visit
www.landa.it

IP43

960°

TOP FINISHING

A
code 350A....



articoli disponibili anche con
cappello in rame
the items are also available
with copper top
ces articles sont disponibles aussi
avec le chapeau en cuivre
piezas disponibles
también en cobre
Diese Artikel sind auch mit
Kupfer-Dach verfügbar

COLOURS

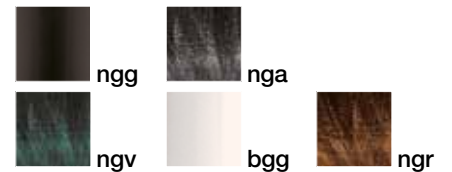

ELECTRIFICATION

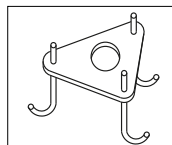
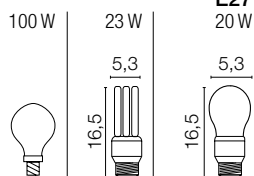

350.PF4....
350.PF5....
350.PF6....

350.PF7....
350.PF8....
350.PE7....
350.PE8....

350.PR5....
350.PR6....

350.PR7....
350.PR8....

Anchor Bolt: code 00APF6

code 00APF8

code 00APR6

code 00APR8

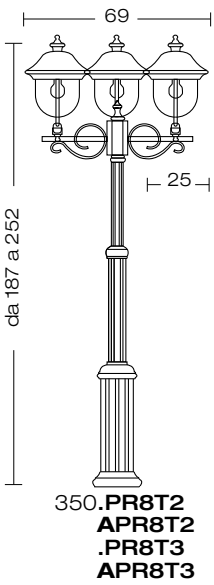
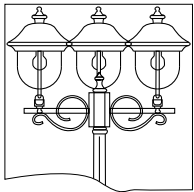
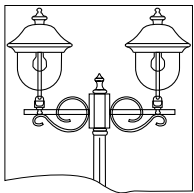
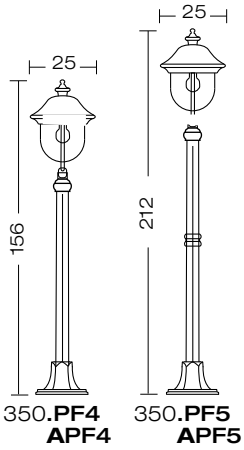

Accessories on request:



code 0404M004
Single connection IP68



code 0404M003
Loop in loop out IP68

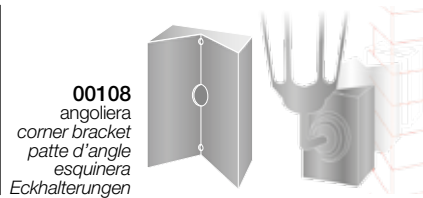

00108
angoliera
corner bracket
patte d'angle
esquinera
Eckhalterungen

esempio di fissaggio
fixing example
exemple de fixation
ejemplo de fijación
Beispiel von Fixierung

LED

powered by
Citizen Electronics® LED
Transformer included

example code:

art.	finishing	size	LED	colour
360	.	01	L10	H ngg

example copper top code:

art.	finishing	size	LED	colour
360	A	01	L5	H ngg

art.
360

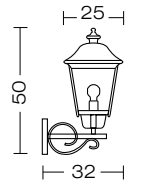

360.**00L5**
.00L5H
.00L10
.00L10H
360**A**...

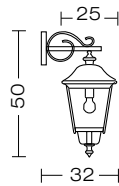

360.**01L5**
.01L5H
.01L10
.01L10H
360**A**...

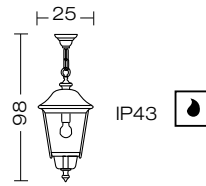

360.**02L5**
.02L5H
.02L10
.02L10H
360**A**...

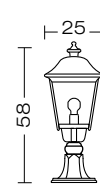

360.**33L5**
.33L5H
.33L10
.33L10H
360**A**...

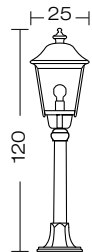

360.**44L5**
.44L5H
.44L10
.44L10H
360**A**...

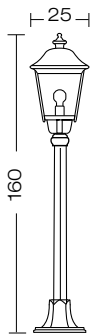

360.**PF4L5**
.PF4L5H
.PF4L10
.PF4L10H
360**A**...

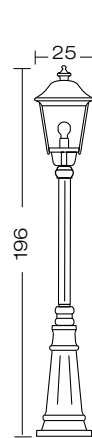

360.**PF7L5**
.PF7L5H
.PF7L10
.PF7L10H
360**A**...

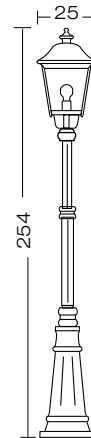

360.**PF8L5**
.PF8L5H
.PF8L10
.PF8L10H
360**A**...

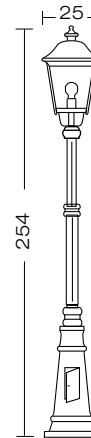

360.**PE8L5**
.PE8L5H
.PE8L10
.PE8L10H
360**A**...

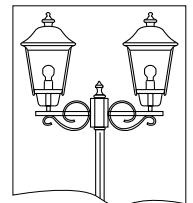

360.....**T2**.....

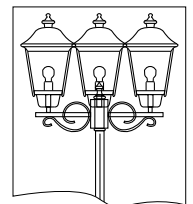

360.....**T3**.....

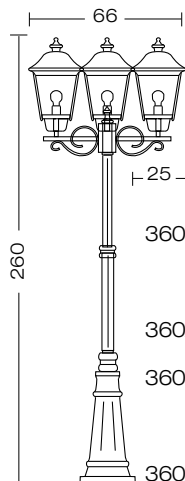

360.**PF8T2L5**
.PF8T2L5H
.PF8T2L10
.PF8T2L10H
360**A**...

360.**PF8T3L5**
.PF8T3L5H
.PF8T3L10
.PF8T3L10H
360**A**...

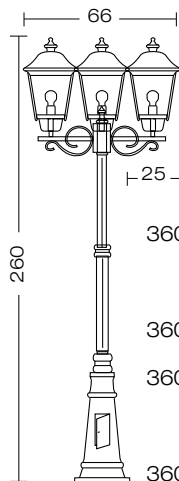

360.**PE8T2L5**
.PE8T2L5H
.PE8T2L10
.PE8T2L10H
360**A**...

360.**PE8T3L5**
.PE8T3L5H
.PE8T3L10
.PE8T3L10H
360**A**...

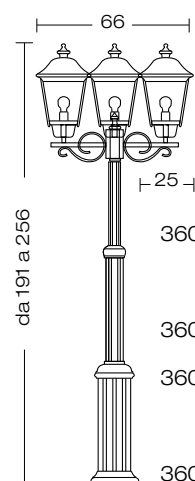

360.**PR8T2L5**
.PR8T2L5H
.PR8T2L10
.PR8T2L10H
360**A**...

360.**PR8T3L5**
.PR8T3L5H
.PR8T3L10
.PR8T3L10H
360**A**...

360**A**..... = copper top version

corpo alluminio pressofuso
body in die casting aluminium
corps en aluminium moulé
sous pression
cuerpo aluminio inyectado
Körper aus Aluminium-
Druckguss

diffusore policarbonato frosted
diffuser frosted polycarbonate
diffuser polycarbonate frosted
difusor policarbonato frosted
Diffuser Polykarbonat frosted

dettagli - details
- details - detalles - details:
pages 138-139

For technical details visit
www.landa.it

IP44

960°

TOP FINISHING



code **360A**.....



articoli disponibili anche con
cappello in rame
the items are also available
with copper top
ces articles sont disponibles aussi
avec le chapeau en cuivre
piezas disponibles
también en cobre
Diese Artikel sind auch mit
Kupfer-Dach verfügbar

COLOURS



ngg



nga



ngv

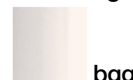

bgg

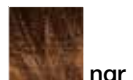

ngr

LED

dettagli /
details / detalles / details:
pages 4-5

L5
LED 5 W
5000°K
430LM
Ra65

L5H
LED 5 W
2900°K
330LM
Ra85

L10
LED 10 W
5000°K
910LM
Ra65

L10H
LED 10 W
2900°K
680LM
Ra85

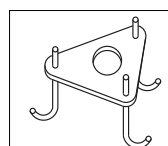

360.PF4.....

Anchor Bolt: code **00APF6**

360.PF7.....
360.PF8.....
360.PE7.....
360.PE8.....

code **00APF8**

360.PR8.....

code **00APR8**



LED



Accessories on request:



code **0404M004**
Single connection IP68



code **0404M003**
Loop in loop out IP68

00108
angoliera
corner bracket
patte d'angle
esquinera
Eckhalterungen

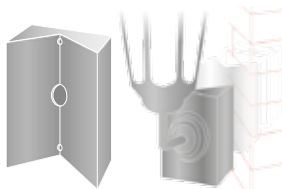

esempio di fissaggio
fixing example
exemple de fixation
ejemplo de fijación
Beispiel von Fixierung

example code:

| art. | finishing | size | colour |
360 . 02 nga

example copper top code:

| art. | finishing | size | colour |
360 **A** 02 nga

art.
360

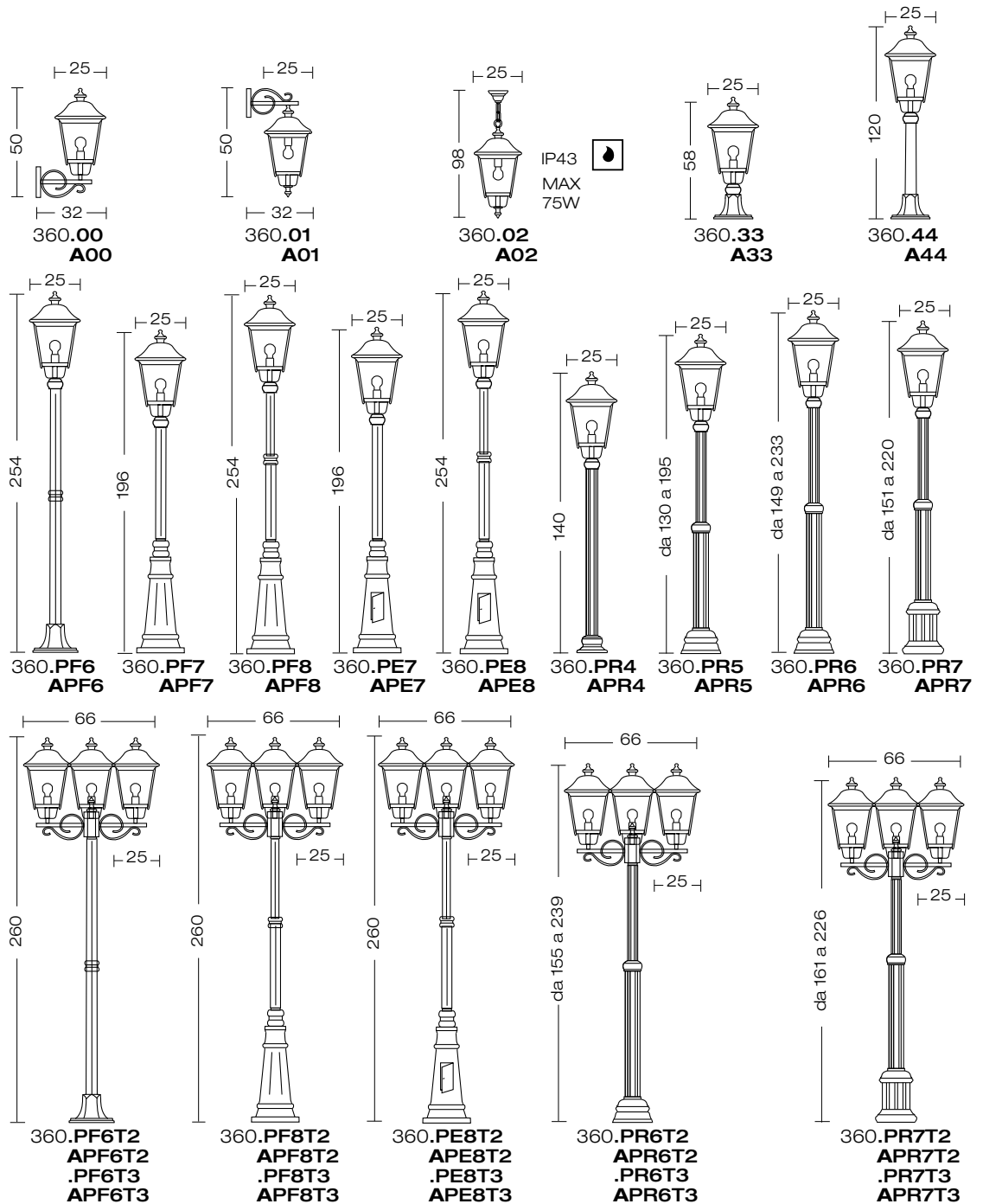

IP43
MAX
75W

corpo alluminio pressofuso
body in die casting aluminium
corps en aluminium moulé
sous pression
cuerpo aluminio inyectado
Körper aus Aluminium-
Druckguss

diffusore policarbonato
trasparente
diffuser transparent
polycarbonate
diffuser polycarbonate
transparent
difusor policarbonato
transparente
Diffuser Polykarbonat klar

dettagli - details
- details - detalles - details:
pages 138-139

For technical details visit
www.landa.it

IP44

96°

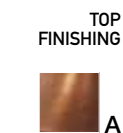

code 360A....



articoli disponibili anche con
cappello in rame
the items are also available
with copper top
ces articles sont disponibles aussi
avec le chapeau en cuivre
piezas disponibles
también en cobre
Diese Artikel sind auch mit
Kupfer-Dach verfügbar

COLOURS

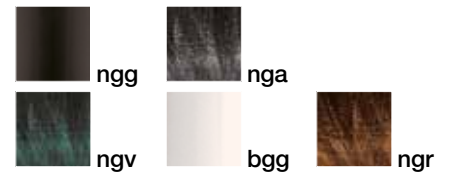

ELECTRIFICATION

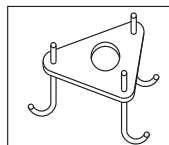
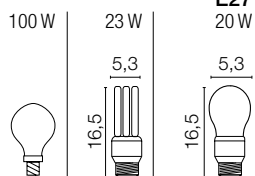

360.PF4....
360.PF5....
360.PF6....

360.PF7....
360.PF8....
360.PE7....
360.PE8....

360.PR5....
360.PR6....

360.PR7....
360.PR8....

Anchor Bolt: code 00APF6

code 00APF8

code 00APR6

code 00APR8

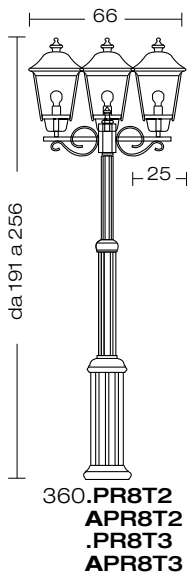
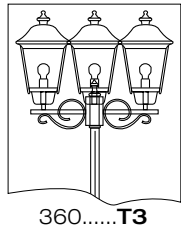
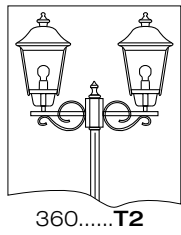
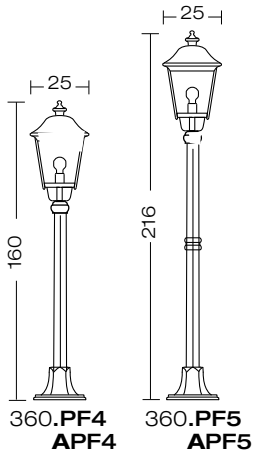

Accessories on request:



00108
angoliera
corner bracket
patte d'angle
esquinera
Eckhalterungen

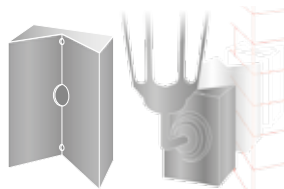

esempio di fissaggio
fixing example
exemple de fixation
ejemplo de fijación
Beispiel von Fixierung

example code:

art.	finishing	size	colour
391	.	01	ngg

art.
390-391

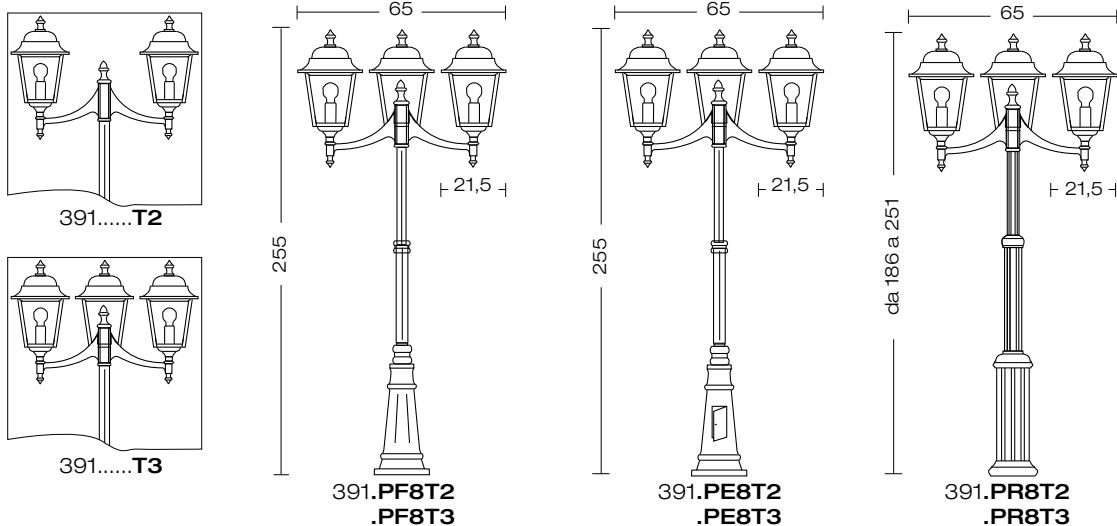
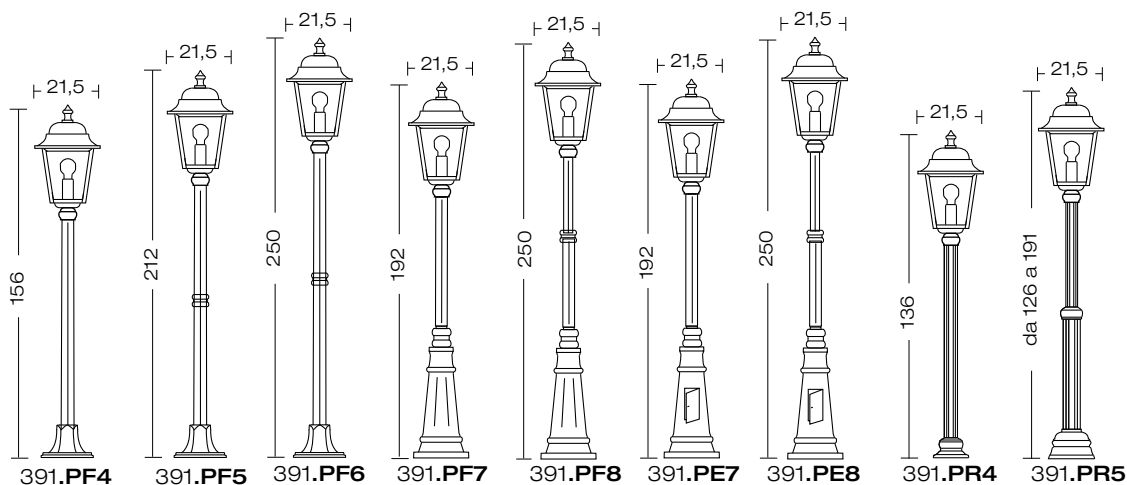
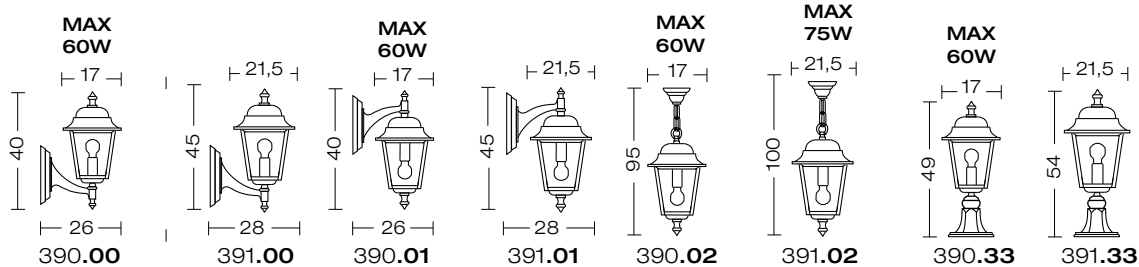

corpo alluminio pressofuso
body in die casting aluminium
corps en aluminium moulé
sous pression
cuerpo aluminio inyectado
Körper aus Aluminium-
Druckguss

diffusore vetro
diffuser glass
diffuser verre
difusor vidrio
Diffuser Glas

dettagli - details
- details - detalles - details:
pages 138-139

For technical details visit
www.landa.it

IP43

COLOURS

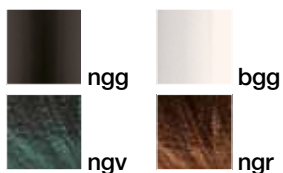

ELECTRIFICATION

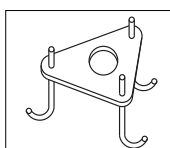
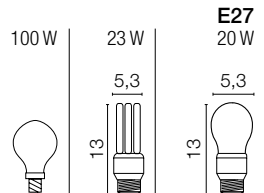

Anchor Bolt: code **00APF6**

391.PF7.....
391.PF8.....
391.PE7.....
391.PE8.....
code **00APF8**

391.PR5.....
391.PR6.....
code **00APR6**

391.PR7.....
391.PR8.....
code **00APR8**

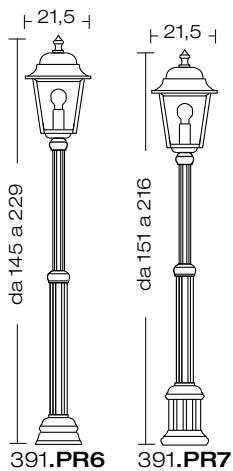
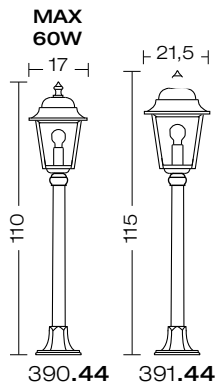

Accessories on request:



code **0404M004**
Single connection IP68



code **0404M003**
Loop in loop out IP68

00108
angoliera
corner bracket
patte d'angle
esquinera
Eckhalterungen

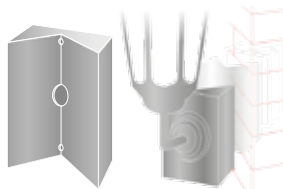

esempio di fissaggio
fixing example
exemple de fixation
ejemplo de fijación
Beispiel von Fixierung

example code:
| art. | finishing | size | colour |
395 . 00 ngv

art.
395

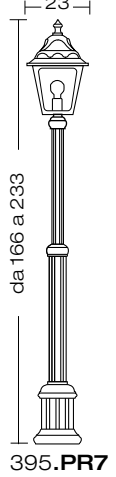
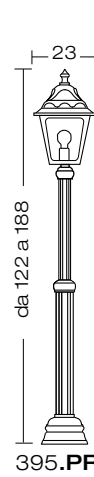
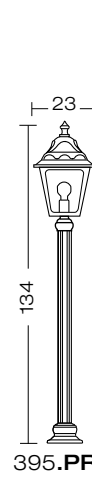
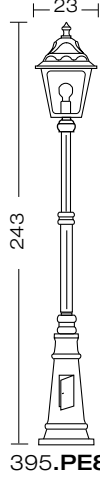
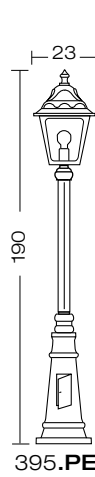
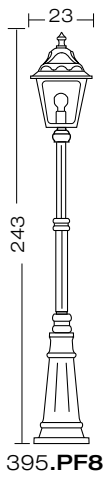
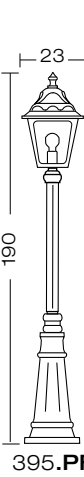
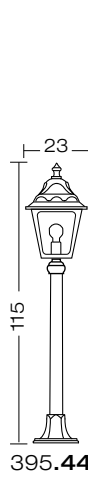
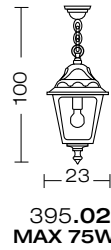
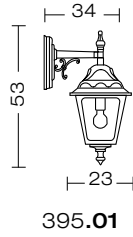
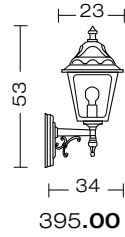

corpo alluminio pressofuso
body in die casting aluminium
corps en aluminium moulé
sous pression
cuerpo aluminio inyectado
Körper aus Aluminium-
Druckguss

diffusore vetro
diffuser glass
diffuser verre
difusor vidrio
Diffuser Glas

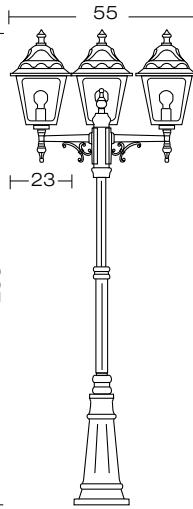
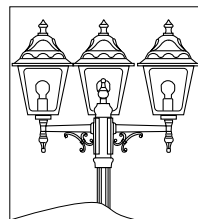
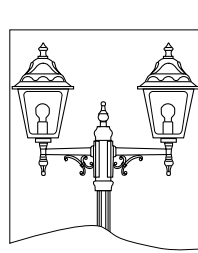

395.PF8T3

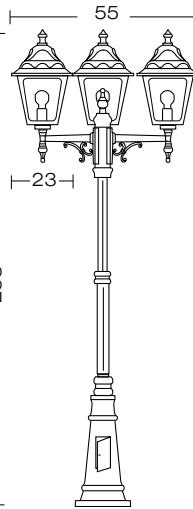

395.PE8T3

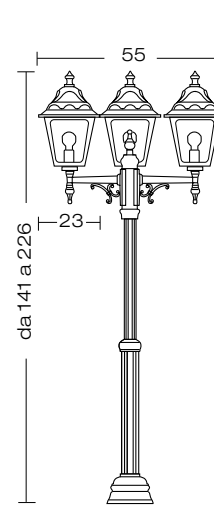

395.PR6T3

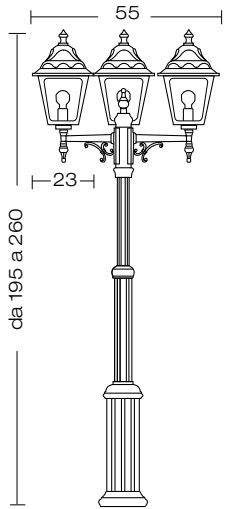

395.PR8T3

dettagli - details
- details - detalles - details:
pages 138-139

For technical details visit
www.landa.it

IP43

COLOURS



ngg



bgg



ngv



ngr

ELECTRIFICATION

100 W



23 W



E27

20 W

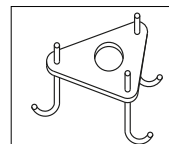

Anchor Bolt:

395.PF7.....
395.PF8.....
395.PE7.....
395.PE8.....

395.PR6.....

395.PR7.....
395.PR8.....

code 00APF8

code 00APR6

code 00APR8



Accessories on request:



code **0404M004**
Single connection IP68



code **0404M003**
Loop in loop out IP68

example code:
| art. | finishing | size | colour |
300 . 02 ngg

art.
300



corpo alluminio pressofuso
body in die casting aluminium
corps en aluminium moulé
sous pression
cuerpo aluminio inyectado
Körper aus Aluminium-
Druckguss

diffusore vetro
diffuser glass
diffuser verre
difusor vidrio
Diffuser Glas

dettagli - details
- details - detalles - details:
pages 138-139

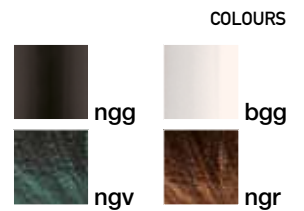
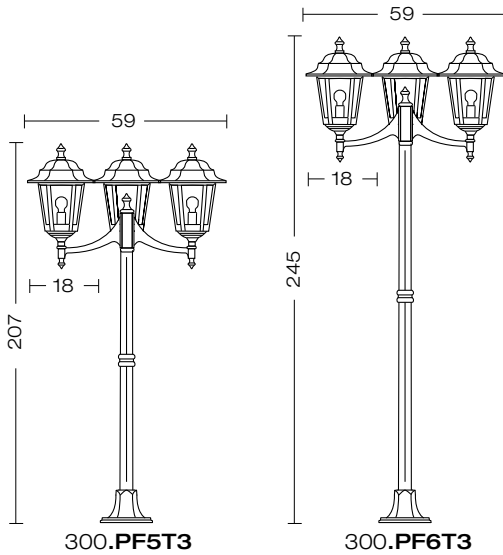
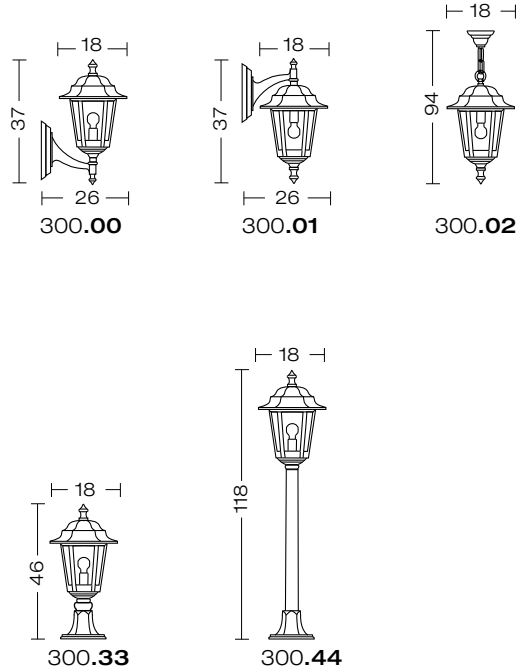

For technical details visit
www.landa.it

IP43

Accessories on request:



code **0404M004**
Single connection IP68



code **0404M003**
Loop in loop out IP68

00108
angoliera
corner bracket
patte d'angle
esquinera
Eckhalterungen

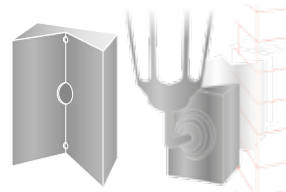

esempio di fissaggio
fixing example
exemple de fixation
ejemplo de fijación
Beispiel von Fixierung

ELECTRIFICATION

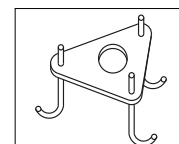
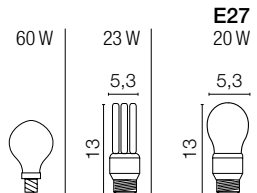

300.PF5....
300.PF6....

Anchor Bolt: code **00APF6**

example code:

art.	finishing	size	colour
301	.	02	ngg

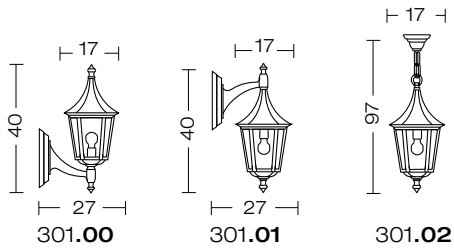

301.00

301.01

301.02

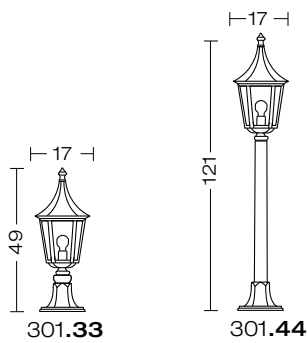

301.33

301.44

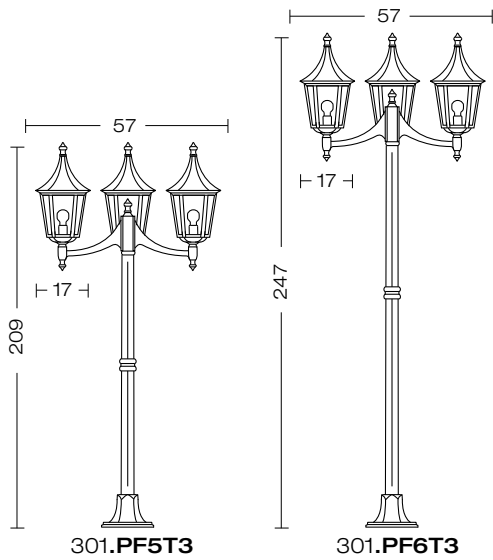

301.PF5T3

301.PF6T3



art.
301



corpo alluminio pressofuso
body in die casting aluminium
corps en aluminium moulé
sous pression
cuerpo aluminio inyectado
Körper aus Aluminium-
Druckguss

diffusore vetro
diffuser glass
diffuser verre
difusor vidrio
Diffuser Glas

COLOURS

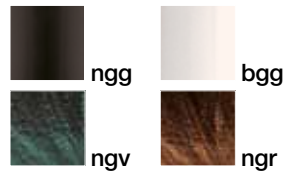

dettagli - details
- details - detalles - details:
pages 138-139

Accessories on request:



code **0404M004**
Single connection IP68



code **0404M003**
Loop in loop out IP68

00108
angoliera
corner bracket
patte d'angle
esquinera
Eckhalterungen

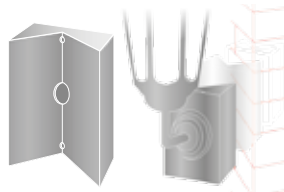

esempio di fissaggio
fixing example
exemple de fixation
ejemplo de fijación
Beispiel von Fixierung

For technical details visit
www.landa.it

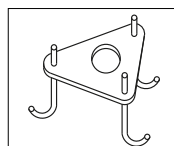

Anchor Bolt: code **00APF6**

301.PF5....
301.PF6.. ...

MAX 60 W	23 W	E27 20 W
	5,3	5,3
	13	13

ELECTRIFICATION

example code:

art. | finishing | electrification | colour
425 | | PL13 | nga

example copper top code:

art. | finishing | electrification | colour
425 | **A** | PL13 | nga

art.
425



trasparente
transparent
transparent
transparente
klar

850°



opale
opal
opale
ópalo
opal

850°

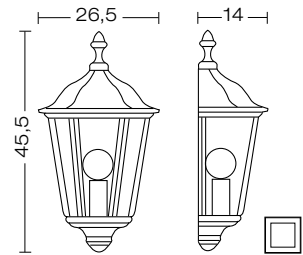

corpo alluminio pressofuso
body in die casting aluminium
corps en aluminium moulé
sous pression
cuerpo aluminio inyectado
Körper aus Aluminium-
Druckguss

code **425B**
425PL13
425F13

code **425AB**
425APL13
425AF13



sensor



dettagli
details
détails
detalles
page 7

diffusore policarbonato
diffuser polycarbonate
diffuser polycarbonate
difusor policarbonato
Diffuser Polykarbonat

For technical details visit
www.landa.it

IP44

TOP
FINISHING



code **425A**....



articoli disponibili anche con
cappello in rame
the items are also available
with copper top
ces articles sont disponibles aussi
avec le chapeau en cuivre
piezas disponibles
también en cobre
Diese Artikel sind auch mit
Kupfer-Dach verfügbar

COLOURS

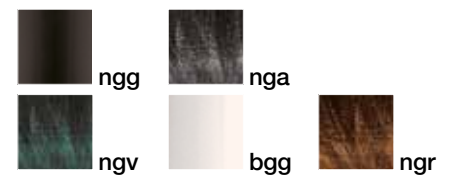

ELECTRIFICATION

	1 x 100 W	1 x 23 W	E27 1 x 20 W	PL13 1 x 13 W G24 d-1	F13 1 x 13 W G24 q-1
425 425A		5,3	5,3		
425B 425SEN 425ASEN		16,5 	16,5 		



serie/series
cipro
maiorca

example code:
 | art. | electrification | colour |
 420 | PL13 | ngv

art.
cipro 420
maiorca 421



corpo alluminio pressofuso
 body in die casting aluminium
 corps en aluminium moulé
 sous pression
 cuerpo aluminio inyectado
 Körper aus Aluminium-
 Druckguss

diffusore policarbonato
 diffuser polycarbonate
 diffuser polycarbonate
 difusor policarbonato
 Diffuser Polykarbonat

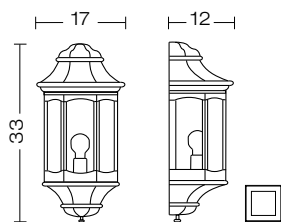

cipro 420
420PL13

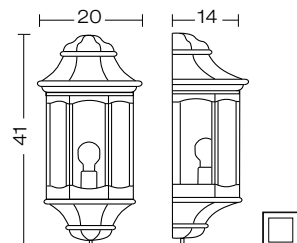

maiorca 421
421PL13
421BSEN



trasparente
 transparent
 transparent
 transparente
 klar

850°

code 420

421



opale
 opal
 opale
 ópalo
 opal

850°

code 420PL13

421PL13

421BSEN

sensor

dettagli
 details
 details
 detalles
 details:
 page 7



For technical details visit
www.landa.it

IP44

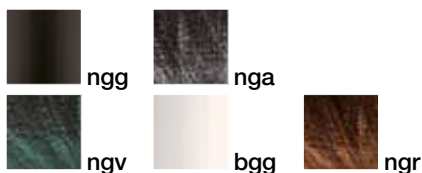

COLOURS



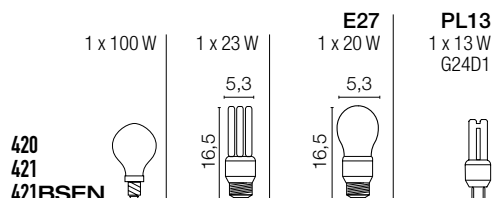









ELECTRIFICATION

































































































































index

-  bulb version (bulbs not included)
-  LED product with LED (LED included)
-  product with sensor

index

CODE					PAGE
00PB060K	pali beta				115
00PB060	pali beta				114
00PB126K	pali beta				115
00PB126	pali beta				114
00A170	pali liberty				116
ACCESSORIES	pali beta/liberty				117
100	lampara				146÷149
110	saturno				150
150	sirio				152
160	toscana				156
165	toscana				154
170	liberty				70
175	morphis				58
176	morphis				60
177	morphis				62
178	morphis				64
179	morphis				66
180	morphis				68
300	pisa				184
301	oslo				185
310	venezia mini				158
311	venezia				160
312	venezia				160
320	amalfi mini				162
321	amalfi				164
322	amalfi				164
323	amalfi maxi				166
330	firenze				168
340	monaco				170
350	romantica				172÷175
360	augusta				176÷179
370	parigi mini				140
371	parigi				142
372	parigi				142
373	parigi maxi				144
374	parigi maxi				144
390	nizza				180
391	nizza				180
395	torino				182
400	orion				98
401	orion				100
402	polos				88
4021	polos				88
403	polos				84÷87
4031	polos				84÷87

CODE					PAGE
405	neway wall				118
405	neway				80÷83
406	oko wall				76÷79
406	oko				76÷79
410	brick light				38
411	brick light				38
412	brick light				38
413	brick light				38
414	brick light				40
4191	wall mira 40				34
4192	wall mira 40				34
4193	wall mira 40				34
4194	wall mira 40				34
4195	wall mira 60				36
4196	wall mira 60				36
420	cipro				188
421	maiorca				188
425	rio				186
430	colonna 52				108
435	colonna 76				110
440	luna wall				90
440	luna				90
450	ibis				74
455	dolby				44
460	lyras 130				50
461	lyras 130				52
462	lyras 130				52
463	lyras 130				52
465	lyras 80				46
466	lyras 80				48
467	lyras 80				48
468	lyras 80				48
4691	lyras 40				54
4695	lyras 60				56
470	ivanhoe				72
5011	mira 200				12÷17
5012	mira 200				18
5013	mira 200				16
5021	mira 200				12÷17
5022	mira 200				18
5023	mira 200				16
5031	mira 200				12÷17
5032	mira 200				18
5033	mira 200				16
5041	mira 200				12÷17
5042	mira 200				18
5043	mira 200				16

CODE					PAGE
5051	mira 200				20
5061	mira 200				20
5111	mira 150				22÷25
5121	mira 150				22÷25
5131	mira 150				22÷25
5141	mira 150				22÷25
5301	mira 60				30
5311	mira 60				32
5401	mira 40				26
5411	mira 40				28
5421	mira 40				28
5431	mira 40				28
550	flute				42
800	orion				102
801	orion				104
810	urano				106
820	titano				96
822	titano				92÷95
9001	cervinia				124
9002	cervinia				122
9005	cervinia				124
9006	cervinia				122
9008	cervinia				120
9100	acqua				126
9103	acqua				126
9109	acqua				126
9111	linea				128
9122B	chicca				128
9123B	chicca				128
9200	colonna 52				108
9200	colonna 52				108
9202	colonna 52				108
9240	colonna 76				110
9270	colonna 114				112
9420	saturno mini				132
9440	urano mini				134
9490	antares				136
9500	lampara				130

PALI					138
Terms & Conditions					192

I prodotti del Gruppo Landa, sono conformi alle norme europee

The products of Landa Group are conformed to European standards.

Les produits du groupe Landa sont conformes aux normes européennes

Los productos del la Landa Group están fabricados según las normativas de la Comunidad Europea

Die Produkte der Gruppe Landa entsprechen den europäischen Vorschriften



Indica che il prodotto è certificato secondo le norme europee.
Indicates that the product conforms to European standards.
Indique que le produit est certifié conformément aux normes européennes.
Los productos están fabricados según las normativas de la Comunidad Europea.
Bedeutet, dass das Produkt entsprechend den europäischen Vorschriften zertifiziert ist.

IP..

"IP" indica la classificazione secondo il grado di protezione contro la penetrazione di polvere, corpi solidi ed umidità.
"IP" indicates the degree of protection against penetration of dust, solid bodies and humidity.
"IP" indique la classification selon le degré de protection contre la pénétration de la poussière, des corps solides et de l'humidité.
"IP": protección contra la penetración de objetos sólidos y protegido contra los líquidos.
"IP" entspricht der Klassifizierung des Schutzgrads in Bezug auf das Eindringen von Staub, festen Körpern und Feuchtigkeit.

IP20

Protetto contro la penetrazione dei corpi solidi Ø >12 mm e non contro i liquidi.
Protected against penetration of solid bodies Ø >12 mm but not against liquids.
Protégé contre la pénétration des corps solides Ø >12 mm et non contre les liquides.
Protección contra la penetración de objetos sólidos menor que 12 mm. y no protegido contra los líquidos
Gegen Eindringen von festen Körpern Ø >12 mm bzw. nicht gegen Flüssigkeiten geschützt.

IP23 

Protetto contro la penetrazione dei corpi solidi Ø >12 mm e contro la pioggia.
Protected against penetration of solid bodies Ø >12 mm and protected against rain.
Protégé contre la pénétration des corps solides Ø >12 mm et protégé de la pluie.
Protección contra la penetración de objetos sólidos menor que 12 mm. y contra el agua en forma de lluvia hasta 60° de inclinación.
Gegen Eindringen von festen Körpern Ø >12 mm sowie gegen Regen geschützt.

IP43 

Protetto contro la penetrazione dei corpi solidi Ø >1 mm e contro la pioggia.
Protected against penetration of solid bodies Ø > 1 mm and protected against rain.
Protégé contre la pénétration des corps solides Ø >1 mm et protégé de la pluie.
Protección contra la penetración de cuerpos sólidos menor que 1 mm. y contra el agua en forma de lluvia hasta 60° de inclinación.
Gegen Eindringen von festen Körpern Ø >1 mm sowie gegen Regen geschützt.

IP44 

Protetto contro la penetrazione dei corpi solidi Ø >1 mm e contro gli spruzzi d'acqua.
Protected against penetration of solid bodies Ø > 1 mm and protected against water sprays.
Protégé contre la pénétration des corps solides Ø >1 mm et contre les éclaboussures d'eau.
Protección contra la penetración de cuerpos sólidos menor que 1 mm. y contra proyecciones de agua en todas direcciones.
Gegen Eindringen von festen Körpern Ø >1 mm sowie gegen Spritzwasser geschützt.

IP54 

Protetto contro la penetrazione della polvere e contro gli spruzzi d'acqua.
Protected against penetration of dust and against water sprays.
Protégé contre la pénétration de la poussière et contre les éclaboussures d'eau.
Protección contra la penetración de polvo y contra proyecciones de agua en todas direcciones.
Gegen Eindringen von Staub sowie gegen Spritzwasser geschützt.

IP55 

Protetto contro la penetrazione della polvere e protetto contro i getti d'acqua.
Protected against penetration of dust and water tight.
Protégé contre la pénétration de la poussière et protégé contre les jets d'eau.
Protección contra la penetración de polvo y contra chorros de agua en todas direcciones.
Gegen Eindringen von Staub sowie gegen Wasserstrahlen geschützt.

IP65 

Stagno alla penetrazione della polvere e protetto contro i getti d'acqua.
Dust tight and protected against water jets.
Étanche à la poussière et protégé contre les jets d'eau.
Totalmente protegida contra la penetración de polvo y contra chorros de agua en todas direcciones.
Staubdicht und geschützt vor Wasserstrahlen.

IP67 

Stagno alla penetrazione della polvere e protetto contro gli effetti delle ondate.
Dust and waterwave tight.
Étanche à la poussière et protégé contre les jets d'eau.
Totalmente protegida contra la penetración de polvo y contra los efectos de la inmersión temporal.
Staubdicht und geschützt vor Wellen.

La ditta si riserva di apportare, senza obbligo di preavviso, tutte le modifiche migliorative riportate agli articoli su questo catalogo.

The company reserves the right to make improvements to the products described in this catalogue without giving prior notice.

L'entreprise se réserve la faculté d'effectuer sans préavis toutes les modifications qu'elle jugera utiles pour améliorer les articles présentes dans ce catalogue.

La firma se reserva, sin previo aviso, de aportar todas las modificaciones que sean necesarias para mejorar sus productos, relatados en este catálogo.

Unsere Firma behält sich vor, Sämtliche Änderungen an den in diesem Katalog enthaltenen Artikeln ohne vorherige Benachrichtigung vorzunehmen, welche aufgrund der technologischen Entwicklung erforderlich sein könnten.

accessori

accessoires
accessoires
accesorios
Zubehör



lampara INOX
9500.PA6T1



code **OODEC**



Liquido per sgrassare, pulire e proteggere gli articoli in acciaio inox AISI 316L
 Maintenance kit for polishing and protecting products in stainless steel AISI 316L
 Liquide pour dégraisser, nettoyer et protéger les articles en acier inoxydable AISI 316L
 Líquido para desengrasar, pulir y proteger los artículos de acero inoxidable AISI 316L
 Flüssigkeit zur Entfettung, Reinigung und zum Schutz von Edelstahloberflächen AISI 316L



code **O404M004**
Single connection IP68

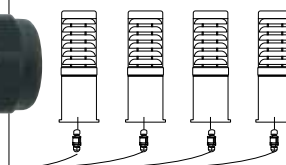

code **O404M003**
Loop in loop out IP68

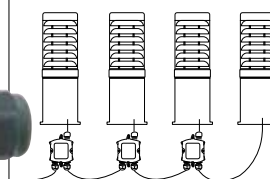

General

- Buyer means the person, firm or company who purchases Goods from the company
- Company means Landa Illuminotecnica S.p.A.. via Rosmini 13/15, 25065 Lumezzane (BS), Italy
- Contract means the Contract between the Buyer and the Company for the sale and purchase of Goods
- Goods means the Goods which the Company is to supply in accordance with these conditions

Basic of Sale

- The Company shall sell and the Buyer shall purchase the Goods in accordance with these conditions, which shall govern the Contract to the exclusion of any other terms and conditions which the Buyer purports to apply under any purchase order, confirmation order, specification or other document
- No variation to these conditions shall be binding unless agreed in writing by the Company
- Any typographical, clerical or other error or omission in any sales literature, quotation, price list, acceptance of offer, invoice or other document or information issued by the Company shall be subject to correction without liability on the part of the Company.
- Goods supplied may vary in detail from illustrations, drawings, measurements and descriptions set out in the Company sales literature, which are approximate and for guidance only and will not form part of the Contract. Colour finishes will be maintained as accurately as possible but matching cannot be guaranteed. All terminology used in the Company's sales literature is subject to these conditions.

Orders

- No order submitted by the Buyer shall be deemed to be accepted by the Company unless and until confirmed in writing by the Company
- The Buyer shall be responsible to the Company for ensuring the accuracy of the terms of any order submitted by the Buyer, and for giving the Company any necessary information relating to the Goods within a sufficient time to enable the Company to perform the Contract in accordance with its terms.
- No Goods may be returned to the Company without the Company's prior written consent and must be returned in their original packaging to ensure no damage is sustained during transit. The Buyer shall be liable for the cost of returning the Goods and for any damage to the Goods prior to receipt by the Company of such returned Goods.

Price of Goods

- The price of the Goods shall be the price listed in the Company's published price list in EURO currency.
- Unless otherwise agreed in writing between the Buyer and the Company, all prices are given by the Company on an ex-works basis, and where the Company agrees to deliver the Goods otherwise than at the Company's premises. The Buyer shall be liable to pay the Company's charges for transport.

Warranties

- Outdoor lighting fixtures are guaranteed against defects in material or workmanship for a period of two years following the date of delivery ex-works.
- No warranty is granted in connection with faults resulting from improper use, application, normal wear and tear, external influences or use of non-original replacement parts, damage resulting from transportation.
- The Company recommends that the installation of outdoor lighting fixtures is made by a skilful person and that the enclosed assembly instructions are followed and kept for further future maintenance.
- The Company will not assume responsibility for corrosion or other resulting damage to the Goods where they are installed in areas in which fertilizer or salt are present, either in the air or in the soil or where Goods are installed near to chemical plants etc with emissions of heavily polluted air. The Buyer undertakes to inform his customers about the regular maintenance of the products. In particular for the products in stainless steel AISI 316, by means of the technical sheets included in his catalogue, the distributor will inform his customer regarding the specific products (among which also those available from the Company aimed to remove possible colour spots) liable to keep the features of the products unaltered. Claims should be promptly submitted in a written form to the Company together with copy of the purchase invoice and stating the delivery date, description of the faults and quantity of faulty products. Products that are proved to be defective in material or workmanship will be repaired, replaced by the Company within a reasonable period after the claim. Returns of faulty Goods will be accepted by the Company only upon written authorization, adequately despatched and packed with transport prepaid. Extra costs borne by the Buyer in consequence of the faults of the products will not be carried by the Company, if not previously agreed in written form.
- The Company will not assume any responsibility in the following cases: improper assembly, use or maintenance of the products and their incorrect conservation. This guarantee shall not apply to products that have been altered, improperly used or installed or repaired without prior written authorization from the Company. If quality and performance have become less due to the application of accessories not approved by the Company. This guarantee deletes and replaces any other further responsibility arising from the products supplied; in particular the Buyer shall have no right to claim for damages reimbursement (indirect or consequent damages included or profit losses) reduction of prices or resolution of the Contract.

LANDA ILLUMINOTECNICA S.p.A.

Via Rosmini, 13/15 - 25065 Lumezzane S.A. - Brescia - Italy - Tel. +39 030 89 20 966 - Fax +39 030 89 21 003 - www.landa.it - e-mail: info@landa.it
Copyright© 2012



LANDA®

illuminotecnica

LANDA illuminotecnica S.p.A.

Via Rosmini, 13/15

25065 Lumezzane S.A. - Brescia - Italy

Tel. +39 030 89 20 966

Fax +39 030 89 21 003

info@landa.it

www.landa.it