



WOFI[®]

leben mit licht

...lights for living

2016

leben mit licht

Schon immer war der Mensch von Licht fasziniert. Licht bringt mehr Wohnlichkeit. Licht schafft ein besonderes Ambiente. Licht setzt individuelle Akzente.

Seit über 50 Jahren entwickelt WOFI Leuchten, die zum Lebensstil passen. Seitdem setzen wir Maßstäbe in der Produktentwicklung. Wir verwandeln aktuelle Trends in ansprechendes Design und neueste Technologie in nachhaltige Effizienz.

Innovationen stehen bei uns im Vordergrund. Das beweisen wir mit jedem der rund 400 Produkte, die wir jährlich neu entwickeln und vermarkten. Und unser dynamisches Wachstum in den letzten fünf Jahrzehnten gibt uns Recht. Doch unser Erfolg ist noch lange kein Grund, sich darauf auszuruhen. Deshalb sammeln wir stets neue Ideen, Erfahrungen und Erkenntnisse und bewerten die Impulse aus dem Markt, um sie in unsere zukunftsweisenden Neuentwicklungen einfließen zu lassen. Das Ergebnis ist in der Branche richtungweisend.

Jedes Jahr aufs Neue ist es daher für uns Verpflichtung und Antrieb zugleich, Ihnen ein bedarfsgerechtes, klar gegliedertes Sortiment zu bieten, das sowohl qualitativ als auch preislich überzeugt. Kombiniert mit unserem exzellenten Service sind wir genau das, was der filialisierte Einzel- und Fachhandel von einem der führenden Anbieter auf dem europäischen Markt erwarten darf: der zuverlässige Lichtpartner mit Erfolgsgarantie.

lights for living

Man has always been fascinated by light. Light adds comfort. Light creates a special ambience. Light sets individual accents.

Over fifty years ago, WOFI began developing lamps to match lifestyle. Ever since, we have been setting the standards of product development. We turn current trends into attractive designs and the latest technology into sustainable efficiency.

We are focused on innovation which we prove by developing and marketing 400 new products every year. And the growth we have experienced in the last five decades has proven us right. Yet our success is no reason for complacency. So we constantly look for new ideas, influences and insights and assess market developments so we can channel them into trend setting new product designs. Our results lead the entire industry.

Year after year, this drives our motivation and our commitment to offer a well-structured product range that combines superior quality with attractive pricing. Add our excellent service, and WOFI is just what retail chain stores and specialty retailers should be able to expect from one of Europe's leading lighting manufacturers: a reliable partner that guarantees success.

online
unter
wofi.de

info@
wofi.de



Qualität von Anfang an

Wir entwickeln unsere Produkte für die Ewigkeit!

Angefangen von der Idee für ein neues Produkt in Zusammenarbeit mit unseren Kunden und renommierten Designern über die Produktionsbegleitung und Beschaffung im In- und Ausland bis hin zur zielgerichteten Vermarktung über ein professionelles Key-Account-Management kombiniert mit modernsten Marketinginstrumenten, obliegt es unserem Licht-Kompetenzzentrum in Meschede-Freienohl die WOFI Erfolgsstory fortzuschreiben. Begleitet wird dieser Prozess durch eines der modernsten Logistikzentren der Branche, das einen hohen Servicegrad garantiert.

Nehmen Sie uns beim Wort!



Quality right from the start

Designing for eternity

The task of ensuring WOFI's continuing success is in the capable hands of the company's lighting competence centre in Meschede-Freienohl. The centre is responsible for developing new product ideas in collaboration with our customers and famous designers. It also oversees the production stage, including the purchasing of materials from Germany and abroad, and the targeted marketing of finished products under the professional guidance of our key account managers using the latest sales tools.

To ensure the smooth running of the entire process and guarantee excellent customer support, WOFI has established one of the most modern logistics centres in the industry.

A name you can trust!



Lumen ist das neue Watt!

Aufgrund europäischer Richtlinien verschwindet die klassische Glühlampe vom Markt.

Eine große Produktvielfalt an Lampen mit unterschiedlichen Energieeffizienzen befindet sich zur Zeit auf dem Markt. Dieses Produktspektrum reicht von unzähligen Variationen und Lampenbauformen, je nach Hersteller und Verwendungszweck (Energiesparlampen, ECO Halogenlampen, LED).

Bei dieser Produktrange verliert die bekannte Vergleichsgröße WATT immer mehr an Bedeutung. Wie viel Helligkeit eine Lampe produziert, verrät sie nicht, sie sagt uns nur etwas über den Energieverbrauch. Um die unterschiedlichen Lampen bezüglich ihrer Energieeffizienz in punkto Lichtleistung besser vergleichen zu können, kommt die aussagekräftige Einheit LUMEN (lm) hinzu.

Der angegebene Wert Lumen/Watt (lm/W) bezieht sich immer nur auf eine Lichtquelle. Um den gesamten Lichtstrom der Leuchte zu ermitteln, ist der Wert mit der Anzahl der Lichtquellen zu multiplizieren.

Beispiel:



Lumen are the new watts!

Due to European energy efficiency guidelines, traditional incandescent light bulbs will disappear from the market.

Right now, consumers can choose from a wide range of lights with different efficiency ratings. Depending on the manufacturer and use, the spectrum of available products includes countless variations and construction types: compact fluorescent lamps, ECO halogen lights and LED lights. This wide range means that the unit of measurement WATTS continually loses importance as a means of comparing lights. It only tells us how much power a light consumes – and nothing about the amount of light it produces.

In order to help consumers compare the energy efficiency and light output of lamps, we are now also using the unit of measurement lumen (lm).

Example:



The indicated value of Lumen/Watt (lm/W) always refers to one light source. In order to calculate the total lighting current please multiply the value with the available light sources.

Alles aus einer Hand:

Von der ersten Idee bis zur fertigen Leuchte.

WOFI – immer mit leuchtendem Beispiel voran.

Damit unsere Leuchten in Ihrem Fachgeschäft gut ankommen, legen wir bei WOFI sehr großen Wert auf hohe Qualität. Um diese zu garantieren, sorgen wir in unserem Licht-Kompetenzzentrum in Meschede-Freienohl dafür, dass unsere Spezialisten aus allen Disziplinen Hand in Hand arbeiten – Design, Konstruktion, Einkauf, Produktion, Marketing und Vertrieb. Nur so können wir zu jeder Phase der Produktentwicklung unsere Kompetenzen bündeln, unser Know-how nutzen und unsere Visionen verwirklichen.

1 Konstruktion

...Drafting

Jetzt wird es Ernst: Unsere Designer und Ingenieure legen alle Details fest und bestimmen die Technologien.

Time to get serious: our designers and engineers work out every detail and determine which types of technology to use.



2 Musterbau

...Prototype Building

Hier wird aus der Theorie endlich Praxis: Was bisher nur virtuell war, ist zum ersten Mal 'anfassbar'. Dank der virtuellen Fertigkeiten unserer Maschinenschlosser, CNC-Fräser, Musterbauer und Feinblechner.

Theory turns into reality: a virtual design finally becomes tangible – thanks to the advanced skills of our machinists, CNC mill operators, prototype builders and sheet metal workers.



7 Service

...Service

Mit der Lieferung ist unser Service noch lange nicht vorbei:

Die Mitarbeiter unserer Serviceabteilung kümmern sich um allgemeine und technische Fragen. Helfen bei Problemen oder Ersatzteilen. Und sind telefonisch oder per Internet für Sie da.

Our commitment doesn't end when we deliver your order:

Our service department associates can answer general and technical questions, help with problems and ship spare parts – on the phone or on the internet.

We do it all:

From drawing the first sketch to producing the final product.

WOFI – a shining example.

We want to ensure our lamps are well received in your shop. So WOFI controls the development and production process from start to finish. After all, we feel there's only one way to guarantee perfect quality in our lighting competence centre in Meschede-Freienohl: to have all of our specialists working hand in hand on all aspects of the development and production process – design, construction, sourcing, production, marketing and sales.

3 Qualitätsmanagement

...Quality Management

Material, Elektronik, Lebensdauer, Handling, Alltagstauglichkeit – das sind nur ein paar unserer vielen Kriterien, die unsere Qualitätsmanager sehr genau nehmen.

Material selection, electrical components, life expectancy, handling and usability – these are just a few criteria that our quality team takes very seriously.

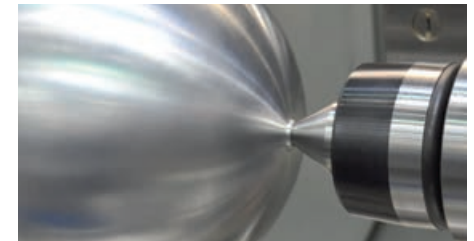

4 Produktion

...Production

Hat ein Produkt den Prozess bis hierhin durchlaufen und konnte unseren hohen Anforderungen standhalten, wird es produziert. Die Produktion unserer Artikel wird permanent durch unsere Inspektoren überwacht.

We'll produce a product only after it has passed all of the above steps and meets with our high standards.

6 WOFI am POS

...Point of Sale

Die richtigen Marketinginstrumente, ein gelungener Markenauftritt sowie moderne und vielseitig einsetzbare Vertriebskonzepte, bringen WOFI am POS zum Leuchten. Unsere Fachleute sorgen vor Ort für die Zufriedenheit Ihrer Kunden.

The appropriate marketing tools, a well-rounded brand image and our modern and multifaceted sales and distribution concepts make WOFI shine at the point of sale. Our on-site experts ensure customer satisfaction.



5 Logistik-Zentrum

...Distribution Centre

Eines der modernsten Logistikzentren der Branche sorgt in Zusammenarbeit mit unserem Bestandsmanager dafür, dass unsere Leuchten überall rechtzeitig und vollzählig ankommen.

Working in one of the most modern distribution centres in the business, our inventory manager ensures that our all of lamps reach their destinations right on schedule.

Technologie auf einen Blick

...Technology at a glance



Halogen technology

Die Halogenlampen haben ein brillantes Akzentlicht mit einer ausgezeichneten Lichtqualität, eine natürliche Lichtwirkung und einen perfekten Farbwiedergabe-Index von 100%. Halogenlampen überzeugen durch natürliche Ausstrahlung: vom klassischen bis hin zu warmen Licht.

Mit ihrer Dimmbarkeit kommen sie als direktes Licht im Arbeitsbereich oder als indirekte Beleuchtung zum Einsatz. Halogenlampen enthalten kein Quecksilber und sind daher problemlos im Hausmüll entsorgbar.

Halogen lamps produce brilliant accent light, delivering outstanding quality, a natural light effect and a perfect colour-rendering index of 100%. Halogen lamps win consumers over with their natural presence, delivering light ranging from classic to warm. Since halogen lights are dimmable, they are used to provide direct lighting in work areas or as an indirect light source. Halogen bulbs do not contain mercury, so they can be disposed of by placing them in the household rubbish.

Retrofit

Durch die stufenweise Abschaffung der Glühlampe wurden die LED Lampen alltagstauglich. Die LED Technologie ist ökologisch wertvoll und ermöglicht ein völlig neues Licht.

Aufgrund der hohen Energieeinsparung haben LEDs einen niedrigen Stromverbrauch und somit eine enorme Einsparung gegenüber herkömmlichen Glühlampen und das bei einer deutlich längeren Lebensdauer im Vergleich zu Halogen- und Glühlampen.

Das Schöne: Auch alte Leuchten können mit LED ausgerüstet werden. Direkter Ersatz von Glüh- und Halogenlampen durch einfaches Austauschen. Alte Lampe raus, neue Lampe rein. Umrüstung, dafür steht der Begriff Retrofit.

As incandescent bulbs are being phased out, LED lights are becoming acceptable for every-day use. LED technology is environmentally responsible and helps facilitate new approaches to light. Due to their high efficiency, LEDs use less power, resulting in enormous cost reduction as well as considerable longer life time compared to incandescent bulbs. And here's the beauty of it: even old lights can be equipped with LEDs. Simply replace the old halogen or incandescent bulb: remove old bulb insert new bulb.

Thus the definition is Retrofit

COB/SMD Chip on Board / Surface mounted device

Das Kürzel „COB“ steht für Chip On Board. Dieses ist eine Produktionstechnologie aus der Mikroelektronik.

Bei dieser Technologie, dem Drahtbonding, werden ungehauste Halbleiter direkt auf eine hoch wärmeleitende Leiterplatte geklebt und danach mit Mikrodrähten zur Platine verbunden. Zur Kontaktierung werden Gold-Drähte im Mikrometerbereich verwendet.

Diese Technologie erlaubt höchste Leistungsdichten auf kleinsten Raum und ist damit sicherlich die effizienteste LED-Technologie mit einer wirkungsvollen Nutzlebensdauer von bis zu 35 Jahren. Beispielsweise kann ein 6 Watt LED-Chip der neuesten Generation die gleiche Lichtleistung, wie eine herkömmliche 60 Watt Glühlampe erzeugen. Das bedeutet eine Einsparung von bis zu 90%. Die herkömmliche Glühlampe verfügt sogar nur über eine Lebensdauer von ungefähr einem Jahr.

COB is an abbreviation for "Chip on Board" and denotes a production process developed for micro-electronics.

During this process, uncased semiconductors are bonded to a highly thermoconductive circuit board. This assembly is connected to the main board with microscopic wires, facilitating high power density in a minuscule space hence it definitely is the most efficient LED technology with an effective live time up to 35 years.

For instance, the newest generation LED chip of 6 Watt can produce the same light output as a conventional incandescent bulb of 60 Watt which means a saving of 90 percent. Additionally, the life time of an incandescent bulb is around one year only.

Der Begriff **surface-mounted device** (SMD, deutsch: oberflächenmontiertes Bauelement) ist ein Fachbegriff aus der Elektronik. SMD-Bauelemente haben im Gegensatz zu Bauelementen der Durchsteckmontage (englisch *Through Hole Technology*, THT), den „bedrahteten Bauelementen“, keine Drahtanschlüsse, sondern werden mittels lötfähiger Anschlussflächen direkt auf eine Leiterplatte gelötet (Flachbaugruppe). Die dazugehörige Technik ist die **Oberflächenmontage** (englisch: *surface-mounting technology*, SMT).

Surface-mounted technology (SMT) is a method for producing electronic circuits in which the components are mounted or placed directly onto the surface of printed circuit boards (PCBs). An electronic device so made is called a **surface-mount device (SMD)**. Both technologies can be used on the same board for components not suited to surface mounting such as large transformers and heat-sinked power semiconductors.

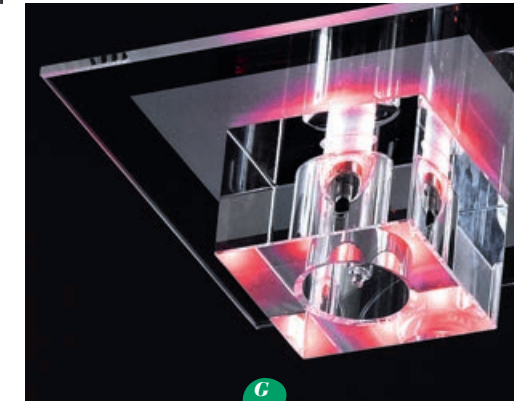

Deko LED

Deko RGB LED-Leuchten kombinieren funktionelles Licht und Farbe. Sie zaubern eine bestimmte Stimmung oder dienen als dekoratives Accessoire. Auf Knopfdruck bringt man unterschiedliche Farben in den Alltag oder setzt eindrucksvolle Akzente. Die Kombination mit energiesparenden Niedervolt-Halogenleuchten macht diese Leuchten zu einer wichtigen Ergänzung in Ihrem Sortiment.

Das RGB steht für die Grundfarben Rot/Grün/Blau aus denen sich alle anderen Farben mischen lassen.

Deco-RGB-LED lights combine functional light and colour. They magically create a special atmosphere or serve as decorative accessories. At the push of a button, you can add different colour to your day or set impressive accents. What's more, the combination with energy saving low-voltage halogen lamps makes these lighting objects an important asset in your range. RGB stands for the colour red/green/blue which can be mixed into all other colors.

clc: Eine Steuerung für alle Leuchten



In Kooperation mit dem Lichtforum NRW haben wir uns mit den unten aufgeführten Leuchten-Herstellern für das europaweit führende HomeMatic-System von eQ-3 entschieden, um einen einheitlichen Standard für die Steuerung von Leuchten zu etablieren.



Das System gewährleistet, dass sich unsere clc-Leuchten durch eine einzige Lichtsteuerung bedienen lassen. Unser Unternehmen möchte Ihnen den größtmöglichen Komfort bieten: „Eine Steuerung für alle Leuchten“.



Über die Zusammenarbeit mit HomeMatic sind clc-gesteuerte Leuchten zudem Bestandteil einer vielfältigen Hausautomation und somit eine herstellerübergreifende Lösung.

Komfortabel, einfach, zukunftsicher

Mit der HomeMatic-Zentrale oder der Telekom Home Base (QIVICON) funktioniert die komfortable Steuerung ganz leicht per App über Smartphone oder Tablet. Unabhängig von einer Zentrale können Sie Ihre Leuchten auch mittels Handsender schalten. Zusätzliche Umbauten, z. B. der Austausch vorhandener Unterputzschalter für Deckenleuchten, sind nicht notwendig! Die gewohnten Schalter bleiben voll funktionsfähig.

Der HomeMatic-Standard stellt zudem sicher, dass neben der Lichtsteuerung auch andere Gewerke (z. B. Heizungssteuerung oder Sicherheitssysteme) in einem Gebäude durch ein einziges, übergreifendes Smart Home-System gesteuert werden können.

Weitere beteiligte Unternehmen:



Entscheiden Sie sich für unsere clc-Leuchten und nutzen Sie die Vielfalt von Hausautomation

Vielfalt ohne Einschränkung

Sie möchten Ihre Leuchten zentral schalten oder dimmen, ohne sich auf ein einzelnes Herstellersystem beschränken zu müssen? Sie möchten in Ihrer Wohnung zu gewissen Zeiten und in verschiedenen Räumen Lichtatmosphären variieren? Dann sind clc-gesteuerte Leuchten genau das Richtige!

Für jeden Lebensbereich

Ob in Wohn- oder Esszimmer, in Küche oder Bad, in Schlaf- oder Kinderzimmer: Nutzen Sie die Leuchtvietfalt namhafter Hersteller und steuern Sie alle Ihre Leuchten – auch von unterwegs.

Achten Sie auf das clc-Zeichen an der Leuchte!

Möglichkeiten der Hausautomation mit HomeMatic

- Wetter & Umwelt**
- Zutrittssteuerung**
- Leuchtensteuerung**
- Heizen & Energiesparen**
- Sicherheit & Alarm**
- Licht & Schatten**

Leuchtensteuerung
Individuelle Lichtszenarien durch kombinierbare Dimm- und Schaltfunktionen.

Licht & Schatten
Zeit- und wetterabhängige Steuerung von Rollläden und Markisen.

Heizen & Energiesparen
Einstellen der Heizung spart Energie und sorgt für ein gesundes Raumklima.

Zutrittssteuerung
Öffnen von Türen und Türen mit einem Tastendruck – auch zeit- bzw. ereignisgesteuert.

Sicherheit & Alarm
Überwachung durch Bewegungs- und Rauchmelder – auch im Urlaub.

Wetter & Umwelt
Bei Sturm und Unwetter kann das Schließen von offenen Fenstern veranlasst werden.

Teilnahme mit freundlicher Genehmigung der eQ-3 AG



Film ab...

Unseren Info-Film zur clc-Steuerung finden Sie im Internet unter: www.clc.lichtforum-nrw.de oder scannen Sie einfach diesen QR-Code.

clc: One control for all your light fixtures



In conjunction with the lighting manufacturers listed below and in cooperation with „Lichtforum NRW“ we have selected the HomeMatic system from eQ-3 – the leading manufacturer of home control and energy management solutions in Europe – as the basis for establishing a uniform lighting-control standard.



The system ensures that our clc-equipped light fixtures can be operated by means of a single control device. Our company would like to offer you the greatest possible convenience: „One control for all your light fixtures.“



Choose clc-equipped light fixtures and enter the world of home automation.

Unlimited variety

Would you like to be able to turn on your lights or dim them from a central location without having to limit yourself to a single manufacturer? Would you like to be able to vary the lighting atmosphere in various rooms in your home at times of your choosing? Then clc-equipped light fixtures are made for you!

For all of life's activities

Whether in your living room or dining room, in the kitchen or the bathroom, in the bedroom or the nursery: Use a huge variety of lighting products from well-known manufacturers and control all of your lights – even when you're on the go. Look for the clc label on lighting products!

Moreover, thanks to collaboration with HomeMatic, clc-equipped light fixtures are part of a multifaceted home-automation system, a solution that is overreaching by means of different manufacturers.

Convenient, simple, future-proof

Through an app on your smartphone or tablet, the convenient controller works very easily with HomeMatic's „Central Control Unit“ or Telekom's „Home Base“ (QIVICON). In case you don't want to use a base station you are also able to turn lights on or off with the aid of a simple remote control. No additional modifications, such as replacing existing wall switches, are required. These familiar switches remain fully operational.

What's more, the HomeMatic standard guarantees that, in addition to lighting control, other building systems (such as heating and cooling or a security setup) can be controlled with a comprehensive smart-home system.

Further companies involved:

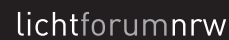

Home-automation possibilities with HomeMatic

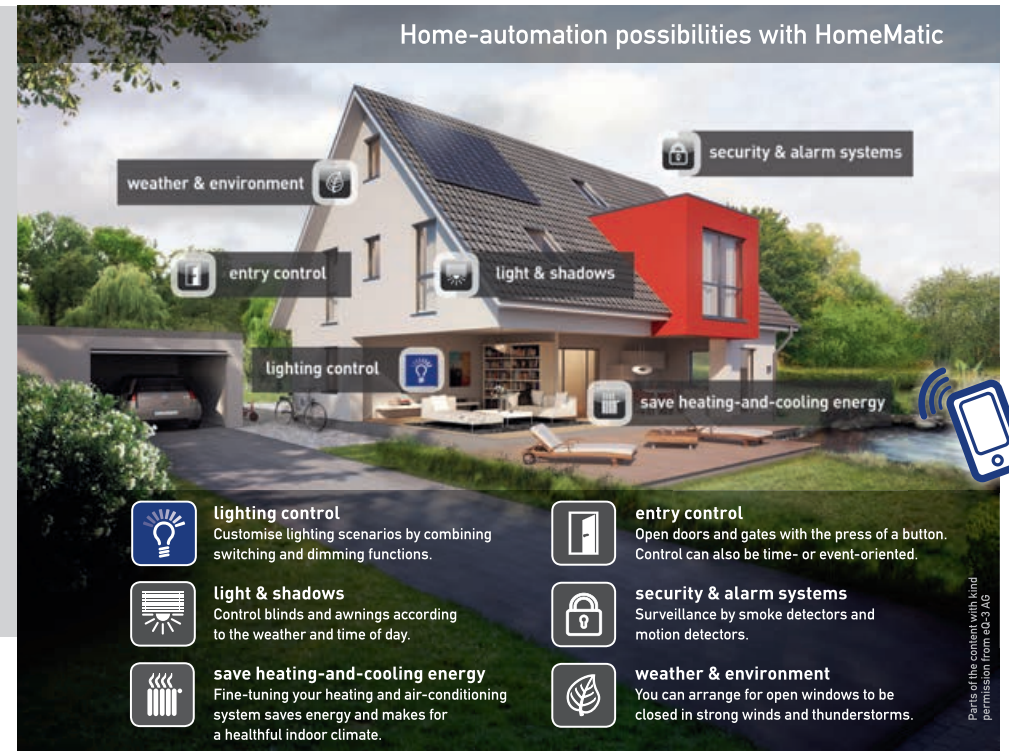

lighting control
Customise lighting scenarios by combining switching and dimming functions.



light & shadows
Control blinds and awnings according to the weather and time of day.



save heating-and-cooling energy
Fine-tuning your heating and air-conditioning system saves energy and makes for a healthful indoor climate.



entry control
Open doors and gates with the press of a button. Control can also be time- or event-oriented.



security & alarm systems
Surveillance by smoke detectors and motion detectors.



weather & environment
You can arrange for open windows to be closed in strong winds and thunderstorms.



Watch the film!

You can find an informative film about our system on the Internet at www.clc.lichtforum-nrw.de, or simply scan this QR code.

Parts of this content with kind permission from eQ-3 AG

EU-Verordnung 874/2012

...EU-Regulations 874/2012

Energieverbrauchskennzeichnung von elektrischen Lampen und Leuchten

Diese Verordnung gilt für Leuchtmittel ab dem 01. September 2013 und für Leuchten ab dem 01. März 2014.

Energy labelling of electrical lamps and luminaires

This regulation will apply to the lamps/bulbs from 1st September 2013 and for the light fitting from 1st March 2014.

Energieeffizienzkennzeichnung

Kennzeichnung durch den einzelnen Buchstaben bedeutet die jeweilige Energieeffizienzklasse des mitgelieferten Leuchtmittels bzw. der fest verbauten LED.

Energy efficiency labelling

Individual letter stands for energy efficiency grade identification of the included bulb or mounted LED.

Beispiel / example:

Mission / Serie 509
7509.02.54.0000
 EAN4003474303109
 Nickel-matt / Chrom /
 Nickel matt finished /
 Chrome

 33 W LED incl.
 3000 K / 2100 lm

Energieeffizienzklasse /
 energy efficiency class:

A

Markenleuchtmittel inkl.
 branded lamp incl.

↓ 150 cm, ↔ 90 cm, ↗ 10 cm

Glas / Glass: 1159,
 ↔ 90 cm, ↓ 3,7 cm, ↗ 12 cm



Alle nicht auswechselbaren, fest verbauten Leuchtmittel / LEDs sind mit folgendem Piktogramm gekennzeichnet:

All not exchangeable, mounted bulbs / LED, are marked with the following picto:



Alle auswechselbaren, nicht fest verbauten Leuchtmittel können mit geeigneten Leuchtmitteln anderer Energieeffizienzklassen getauscht werden.

All exchangeable, not mounted bulbs can be replaced by suitable bulbs of different energy efficiency grade.

Folgendes Beispiel zeigt für welche Energieeffizienzklasse die jeweilige Leuchte geeignet ist sowie auch die mögliche Fassung und die maximale Watt Angabe.

The following example shows for which energy efficiency grade the lighting fixture is suitable for as well as the possible socket and the maximum wattage of each lamp.

Beispiel / example:

Zoon / Serie 192
6192.01.01.0000
 EAN4003474269436
 Chrom / Chrome
 geeignet für / suitable for /
 Energieeffizienzklasse /
 energy efficiency class:

A++

 1 x E27 /
 max.60 W

Fit for LED

Ø 30 cm, ↓ 150 cm,

Glas weiß mit
 Spiraldekor /
 Glass white with
 spiral decoration
 Glas / Glass: 6173

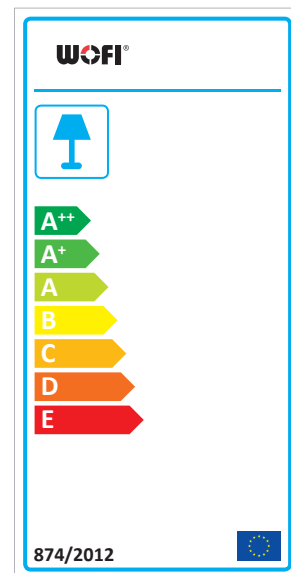

5 Jahre Garantie

...5 years guarantee

Für alle Produkte aus dem WOFI Sortiment, die nach dem 01.01.2013 von Verbrauchern gekauft wurden, bietet WOFI LEUCHTEN eine kostenlose, über die gesetzliche Gewährleistung von 24 Monaten hinausgehende, 5-Jahres-Garantie an.

Nähere Informationen hierzu finden Sie in der Garantieerklärung auf unserer Internetseite unter: www.wofi.de.

For all products out of the WOFI assortment, which have been bought after 01.01.2013 by the enduser, WOFI is offering a free 5-year-guarantee that exceeds the implied warranty of 24 months.

For more information please see the guarantee bond which is available on our website www.wofi.de.

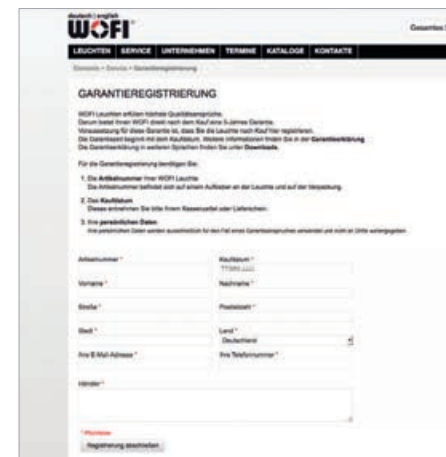

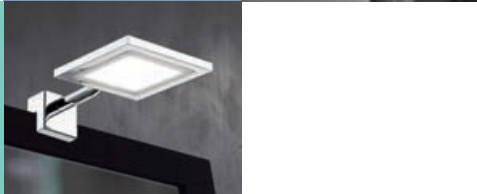
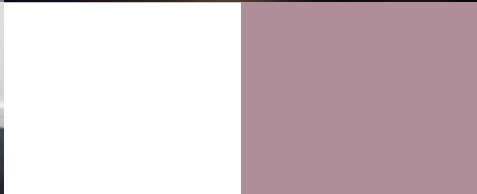
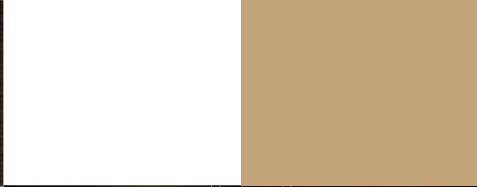

008

Produktfamilien / product families

Modern / Modern

010-011 Seattle, Vannes	024-025 Napa, Horton	036-037 Benett, Vela	044-045 Filiz, Toulouse
012-013 Vannes	026-027 Logan, Soul, Hook	038-039 Crux, Xenia, Aurora, Lex	046-047 Toulouse
014-015 Colmar	028-029 Davis, Segura	040-041 Laval, Orland, Fulton	048-049 Class, Troja
016-017 Kelton, Louvre	030-031 Luz, Mercur	042-043 Midu, Maar, Cleo, Kent	050-051 Deventer, Lacchino
018-019 Trois, Avignon	032-033 Banks, Camp, Montreal		052-053 Verre, Arc
020-021 Galax	034-035 Orbit, Troy		054-055 Astro, Arc
022-023 Kennett, Sorel			

056

Produktfamilien / product families

Kristall-Leuchten / Crystal lamps

058-059 | Arizona, Marquis, Holly

060

Höhenverstellbare Pendelleuchten / Height adjustable pendants

062-063 Evry, Mission, Layton, Freya	068-069 Ava, Madison, Parker, Georgia	072-073 Point, Zoon, Flame, Clara, Chateau	075 weitere höhenverstellbare Pendelleuchten / additional height adjustable pendants
064-065 Darwin, Laurids, Vileta, Lara	070-071 Savannah, Santa Fee, Augusta, Sacramento	074 Mali	
066-067 Roma, Nero, Atlanta, Talas			

076

Stand- und Tischleuchten / Floor and table lamps

078-079 Point, Lex, Orland, Fork, Lee	082-083 Yon, Caja, Fin, Atkins	086-087 Vitro, Vant, Jay, Skin	087 weitere Stand- und Tischleuchten / additional floor and table lamps
080-081 Bristol, Newton, Prescott, Pop, Savannah	084-085 Lou, Twin, Liverpool, Eve		

088

Wand- und Deckenleuchten / Wall and ceiling lamps

090-091 Kiana, Ceres, Jaden, Sila	096-097 Rondo, Space, Modo, Nancy	102-103 Everett, Atkins, Reims, Lore	108 Zibo, Eddy, Aqaba
092-093 Liv, Clay	098-099 Cholet, Lilian, Chloe	104-105 Bois, Dora, Mira, Sphinx	109 weitere Wand- und Deckenleuchten / additional wall and ceiling lamps
094-095 Soul, Estera, Noemi, Surrey	100-101 Midu, Kent, Glam, Delmar	106-107 Braez, Jil, Luv, Kanpur, Figo	

110

Strahler series / Spotlight series

112-113 Hook, Morris	118-119 Anitbes, Maar	124-125 Quincy, Marco
114-115 Fulton, Chloe	120-121 Colo, Steele	126-127 Angola
116-117 Vileta, Atkins	122-123 Cameron, Eve	128-129 Nini

130

SPA line

132-133 Ceres, Meran, Suri, Pax, Luce, Veneta	136-137 Midu, Kent, Oasis, Maar, Antibes
134-135 Sonett, Clayton, Fey, Artus	138-139 Lorient, Oslo, Halden, Mila, Mara

140

Outdoor line

142-143 Austin, Brook, Newark, Brooklyn, Soho, Hall	146-147 Lua, Bronx
144-145 Astoria, Yard, Sutter, Harris	

148-149 Außendienst Sales Representatives	152-154 General Information	155 Allgemeine Verkaufsbedingungen	156-160 Index / Index	161 Serienverzeichnis / Series Index	161 Farbschlüssel / Color Key	162 - 163 Zeichenerklärung / Signs & symbols	164 Kontakt / Contact
---	-------------------------------	--------------------------------------	-------------------------	--	---------------------------------	--	-------------------------



Modern ...Modern

Innovationen für Morgen

Seit der Erfindung der Glühlampe hat sich viel getan. Nicht nur in der Technologie, sondern auch im Design. So hat sich manche praktische Lichtquelle inzwischen zu einem modernen Leuchtobjekt entwickelt und wird immer öfter als schöner Blickfang platziert.

Innovations for tomorrow

Much has changed since the invention of the light bulb – both in terms of technology and design. Many practical light sources have become modern lighting objects and are being used as beautiful eye catchers.

Seattle 010	Segura 029	Fulton 041
Vannes 011	Luz 030	Midu 042
Colmar 014	Mercur 031	Maar 043
Kelton 016	Banks 032	Kent 043
Louvre 017	Camp 033	Cleo 043
Trois 018	Montreal 033	Filiz 044
Avignon 019	Orbit 034	Toulouse 045
Galax 020	Troy 035	Class 048
Kennett 022	Benett 036	Troja 049
Sorel 023	Vela 037	Deventer 050
Napa 024	Crux 038	Lacchino 051
Horton 025	Xenia 038	Verre 052
Logan 026	Aurora 038	Arc 053
Soul 026	Lex 039	Astro 054
Hook 027	Laval 040	Arc 055
Davis 028	Orland 040	

35W
2400 Lumen

25W
1600 Lumen

LED Light
by **WOFI**

1 Seattle / Serie 705
3705.04.01.0000
EAN4003474301686
Chrom / Chrome

 1 x LED / 35 W incl.
3000 K / 1 x 2400 lm

 3 x LED / 25 W incl.
3000 K / 3 x 1600 lm

Energieeffizienzklasse /
energy efficiency class:

A

Markenleuchtmittel inkl.
branded lamp incl.

↑ 180 cm, Ø 45 cm



Softstart-Memoryfunktion
softstart memory function

2 Seattle / Serie 705
3705.04.01.0CLC
EAN4003474305721
Chrom / Chrome

 1 x LED / 35 W incl.
3000 K / 1 x 2400 lm

 3 x LED / 25 W incl.
3000 K / 3 x 1600 lm

Energieeffizienzklasse /
energy efficiency class:

A

Markenleuchtmittel inkl.
branded lamp incl.

↑ 180 cm, Ø 45 cm



per App steuerbar /
operable by App



Luxus bis in die kleinste Ecke ...Luxury in every corner



8W
500 Lumen

3 Seattle / Serie 705
8705.03.01.0000
EAN4003474302812
Chrom / Chrome

 3 x LED / 8 W incl.
3000 K / 3 x 500 lm

Energieeffizienzklasse /
energy efficiency class:

A

Markenleuchtmittel inkl.
branded lamp incl.

↑ 47 cm, Ø 22,5 cm



Softstart-Memoryfunktion
softstart memory function

4 Seattle / Serie 705
8705.03.01.0CLC
EAN4003474305738
Chrom / Chrome

 3 x LED / 8 W incl.
3000 K / 3 x 500 lm

Energieeffizienzklasse /
energy efficiency class:

A

Markenleuchtmittel inkl.
branded lamp incl.

↑ 47 cm, Ø 22,5 cm



per App steuerbar /
operable by App

25W
1600 Lumen



clc collective
light
control
powered by
HomeMatic

 SMART
HOME
READY

5 Seattle / Serie 705
3705.03.01.0000
EAN4003474301808
Chrom / Chrome

 3 x LED / 25 W incl.
3000 K / 3 x 1600 lm

Energieeffizienzklasse /
energy efficiency class:

A

Markenleuchtmittel inkl.
branded lamp incl.

↑ 147 cm, Ø 33 cm



Softstart-Memoryfunktion
softstart memory function

6 Seattle / Serie 705
3705.03.01.0CLC
EAN4003474305714
Chrom / Chrome

 3 x LED / 25 W incl.
3000 K / 3 x 1600 lm

Energieeffizienzklasse /
energy efficiency class:

A

Markenleuchtmittel inkl.
branded lamp incl.

↑ 147 cm, Ø 33 cm



per App steuerbar /
operable by App

1 Vannes / Serie 625
7625.01.01.1000
 EAN4003474301723
 Chrom / Chrome



 1 x LED / 40 W incl.
 3000 K / 1 x 2600 lm

Energieeffizienzklasse /
 energy efficiency class:

A

Markenleuchtmittel inkl.
 branded lamp incl.

↓ 150 cm, ↔ 127 cm, ↗ 14,5 cm

  3-Stufen dimmbar
 3-step dimmable

40W

2600
 Lumen

Neu!
New!

Elegante Raumwunder

...Elegant space savers

Vorbildlich

Diese Serie ist ein Musterbeispiel dafür, dass schönes Design auch Platz für Funktionalität lassen kann.

Exemplary

Proof positive that beautiful design can work with functionality.



30W

1900
 Lumen

2 Vannes / Serie 625
7625.01.01.0900
 EAN4003474302850
 Chrom / Chrome

 1 x LED / 30 W incl.
 3000 K / 1 x 1900 lm

Energieeffizienzklasse /
 energy efficiency class:

A

Markenleuchtmittel inkl.
 branded lamp incl.

↓ 150 cm, ↔ 90 cm, ↗ 13 cm

  3-Stufen dimmbar
 3-step dimmable

20W

1300
 Lumen

3 Vannes / Serie 625
8625.01.01.1000
 EAN4003474301747
 Chrom / Chrome

 1 x LED / 20 W incl.
 3000 K / 1 x 1300 lm

Energieeffizienzklasse /
 energy efficiency class:

A

Markenleuchtmittel inkl.
 branded lamp incl.

Ø 14 cm, ↓ 59 cm

  3-Stufen dimmbar
 3-step dimmable



40W
2600
Lumen

1 Vannes / Serie 625
7625.01.01.0000
EAN4003474280608
Chrom / Chrome

 1 x LED / 40 W incl.
3000 K / 1 x 2600 lm

Energieeffizienzklasse /
energy efficiency class:

A

Markenleuchtmittel inkl.
branded lamp incl.

∩ 150 cm, ↔ 127 cm, ↗ 14,5 cm

Dimmbar mittels geeignetem
Wanddimmer / dimmable by
suitable wall dimmer



2 Vannes / Serie 625
7625.01.01.0CLC
EAN4003474305776
Chrom / Chrome

 1 x LED / 40 W incl.
3000 K / 1 x 2600 lm

Energieeffizienzklasse /
energy efficiency class:

A

Markenleuchtmittel inkl.
branded lamp incl.

∩ 150 cm, ↔ 127 cm, ↗ 14,5 cm

per App steuerbar /
operable by App



10,5W
680
Lumen

3 Vannes / Serie 625
8625.01.01.0000
EAN4003474280622
Chrom / Chrome

 1 x LED / 10,5 W incl.
3000 K / 1 x 680 lm

Energieeffizienzklasse /
energy efficiency class:

A

Markenleuchtmittel inkl.
branded lamp incl.

∅ 12,5 cm, ∩ 39 cm

 3-Stufen dimmbar
3-step dimmable

4 Vannes / Serie 625
8625.01.01.0CLC
EAN4003474305783
Chrom / Chrome

 1 x LED / 10,5 W incl.
3000 K / 1 x 680 lm

Energieeffizienzklasse /
energy efficiency class:

A

Markenleuchtmittel inkl.
branded lamp incl.

∅ 12,5 cm, ∩ 39 cm



per App steuerbar /
operable by App



LED Light
by WOFI

8,5W
 550 Lumen



5 Vannes / Serie 625
4625.01.01.0000
EAN4003474004211
Chrom / Chrome

1 x LED / 8,5 W incl.
3000 K / 1 x 550 lm

Energieeffizienzklasse /
energy efficiency class:
A

Markenleuchtmittel inkl.
branded lamp incl.

↓ 11,5 cm, ↔ 32 cm, ↗ 11,5 cm

6 Vannes / Serie 625
4625.01.01.0CLC
EAN4003474305769
Chrom / Chrome

1 x LED / 8,5 W incl.
3000 K / 1 x 550 lm

Energieeffizienzklasse /
energy efficiency class:
A

Markenleuchtmittel inkl.
branded lamp incl.

↓ 11,5 cm, ↔ 32 cm, ↗ 11,5 cm

per App steuerbar /
operable by App

7 Vannes / Serie 625
3625.01.01.0000
EAN4003474280615
Chrom / Chrome

1 x LED / 36 W incl.
3000 K / 1 x 2340 lm

Energieeffizienzklasse /
energy efficiency class:
A

Markenleuchtmittel inkl.
branded lamp incl.

↓ 143 cm, ↔ 22 cm

3-Stufen dimmbar
3-step dimmable

8 Vannes / Serie 625
3625.01.01.0CLC
EAN4003474305752
Chrom / Chrome

1 x LED / 36 W incl.
3000 K / 1 x 2340 lm

Energieeffizienzklasse /
energy efficiency class:
A

Markenleuchtmittel inkl.
branded lamp incl.

↓ 143 cm, ↔ 22 cm

per App steuerbar /
operable by App

36W
 2340 Lumen



9 Vannes / Serie 625
9625.01.01.0000
EAN4003474285856
Chrom / Chrome

1 x LED / 21,5 W incl.
3000 K / 1 x 1400 lm

Energieeffizienzklasse /
energy efficiency class:
A

Markenleuchtmittel inkl. /
branded lamp incl.

↔ 61,5 cm, ↓ 10,5 cm

Dimmbar mittels geeignetem
Wanddimmer / dimmable by
suitable wall dimmer

21,5W
 1400 Lumen

10 Vannes / Serie 625
9625.01.01.0CLC
EAN4003474305790
Chrom / Chrome

1 x LED / 21,5 W incl.
3000 K / 1 x 1400 lm

Energieeffizienzklasse /
energy efficiency class:
A

Markenleuchtmittel inkl.
branded lamp incl.

↔ 61,5 cm, ↓ 10,5 cm

per App steuerbar /
operable by App





28,8W
1870 Lumen

LED Light
by WOFI

1 Colmar / Serie 234
9234.01.01.0000
EAN4003474127187
Chrom / Chrome

Markenleuchtmittel inkl.
branded lamp incl.

↔ 120 cm, ↗ 8 cm, ⊥ 21 cm

Dimmbar mittels geeignetem Wanddimmer / *dimmable by suitable wall dimmer*

1 x LED / 28,8 W incl.
3000 K / 1 x 1870 lm

Energieeffizienzklasse / *energy efficiency class:*

A

2 Colmar / Serie 234
9234.01.01.0CLC
EAN4003474305875
Chrom / Chrome

Markenleuchtmittel inkl.
branded lamp incl.

↔ 120 cm, ↗ 8 cm, ⊥ 21 cm

per App steuerbar / *operable by App*

1 x LED / 28,8 W incl.
3000 K / 1 x 1870 lm

Energieeffizienzklasse / *energy efficiency class:*

A



5 Colmar / Serie 234
3234.01.01.0000
EAN4003474255002
Chrom / Chrome

1 x LED / 26,4 W incl.
3000 K / 1 x 1720 lm

Energieeffizienzklasse / *energy efficiency class:*

A

Markenleuchtmittel inkl.
branded lamp incl.

⊥ 142 cm, ↔ 23 cm, ↗ 17 cm

3-Stufen dimmbar
3-step dimmable

6 Colmar / Serie 234
3234.01.01.0CLC
EAN4003474305837
Chrom / Chrome

1 x LED / 26,4 W incl.
3000 K / 1 x 1720 lm

Energieeffizienzklasse / *energy efficiency class:*

A

Markenleuchtmittel inkl.
branded lamp incl.

⊥ 142 cm, ↔ 23 cm, ↗ 17 cm

per App steuerbar / *operable by App*

26,4W
1720 Lumen

powered by HomeMatic

Neu!

17 cm
23 cm



7W
460 Lumen

3 Colmar / Serie 234
9234.03.01.0000
EAN4003474303833
Chrom / Chrome

Markenleuchtmittel inkl.
branded lamp incl.

⊥ 32 cm, ↔ 32 cm, ⊥ 9 cm

Dimmbar mittels geeignetem Wanddimmer / *dimmable by suitable wall dimmer*

3 x LED / 7 W incl.
3000 K / 3 x 460 lm

Energieeffizienzklasse / *energy efficiency class:*

A



7W
460 Lumen

4 Colmar / Serie 234
9234.03.01.0500
EAN4003474306100
Chrom / Chrome

Markenleuchtmittel inkl.
branded lamp incl.

↔ 57,5 cm, ↗ 50 cm, ⊥ 11,5 cm

Dimmbar mittels geeignetem Wanddimmer / *dimmable by suitable wall dimmer*

3 x LED / 7 W incl.
3000 K / 3 x 460 lm

Energieeffizienzklasse / *energy efficiency class:*

A



7 Colmar / Serie 234
8234.01.01.0000
 EAN4003474280806
 Chrom / Chrome

1 x LED / 10,2 W incl.
 3000 K / 1 x 660 lm

Energieeffizienzklasse /
 energy efficiency class:

A

Markenleuchtmittel inkl.
 branded lamp incl.

↓ 44 cm, ↔ 10 cm, ↗ 15 cm

3-Stufen dimmbar
 3-step dimmable

8 Colmar / Serie 234
8234.01.01.0CLC
 EAN4003474305868
 Chrom / Chrome

1 x LED / 10,2 W incl.
 3000 K / 1 x 660 lm

Energieeffizienzklasse /
 energy efficiency class:

A

Markenleuchtmittel inkl.
 branded lamp incl.

↓ 44 cm, ↔ 10 cm, ↗ 15 cm

per App steuerbar /
 operable by App

11 Colmar / Serie 234
4234.01.01.0000
 EAN4003474280790
 Chrom / Chrome

1 x LED / 6,8 W incl.
 3000 K / 1 x 440 lm

Energieeffizienzklasse /
 energy efficiency class:

A

Markenleuchtmittel inkl.
 branded lamp incl.

↔ 31 cm, ↓ 8 cm, ↗ 7 cm

3-Stufen dimmbar
 3-step dimmable

12 Colmar / Serie 234
4234.01.01.0CLC
 EAN4003474305844
 Chrom / Chrome

1 x LED / 6,8 W incl.
 3000 K / 1 x 440 lm

Energieeffizienzklasse /
 energy efficiency class:

A

Markenleuchtmittel inkl.
 branded lamp incl.

↔ 31 cm, ↓ 8 cm, ↗ 7 cm

per App steuerbar /
 operable by App

6,8W

440
 Lumen



LED Light
 by **WOFI**

9 Colmar / Serie 234
7234.01.01.0000
 EAN4003474280783
 Chrom / Chrome

1 x LED / 28,8 W incl.
 3000 K / 1 x 1870 lm

Energieeffizienzklasse /
 energy efficiency class:

A

Markenleuchtmittel inkl.
 branded lamp incl.

↓ 150 cm, ↔ 120 cm, ↗ 8 cm

Dimmbar mittels geeignetem
 Wanddimmer / dimmable by
 suitable wall dimmer

28,8W

1870
 Lumen

10 Colmar / Serie 234
7234.01.01.0CLC
 EAN4003474305851
 Chrom / Chrome

1 x LED / 28,8 W incl.
 3000 K / 1 x 1870 lm

Energieeffizienzklasse /
 energy efficiency class:

A

Markenleuchtmittel inkl.
 branded lamp incl.

↓ 150 cm, ↔ 120 cm, ↗ 8 cm

per App steuerbar /
 operable by App

Neu!
Neu!



LED Light
by WOFI

12W
700
Lumen



1 Kelton / Serie 017
9017.06.54.0000
EAN4003474299525
Nickel-matt/Chrom /
Nickel matt finished/Chrome

 12 W LED incl.
3000 K / 700 lm

Energieeffizienzklasse /
energy efficiency class:

A

Markenleuchtmittel inkl.
branded lamp incl.

↓ 52 cm, ↔ 52 cm, ↗ 5 cm

Neu!
New!



6,5W
450
Lumen

2 Kelton / Serie 017
8017.02.54.0000
EAN4003474299518
Nickel-matt/Chrom /
Nickel matt finished/Chrome

 6,5 W LED incl.
3000 K / 450 lm

Energieeffizienzklasse /
energy efficiency class:

A

Markenleuchtmittel inkl.
branded lamp incl.

↓ 41,5 cm, ↔ 12,5 cm, ↗ 13 cm



4W
300
Lumen

3 Kelton / Serie 017
4017.02.54.0000
EAN4003474299501
Nickel-matt/Chrom /
Nickel matt finished/Chrome

 4 W LED incl.
3000 K / 300 lm

Energieeffizienzklasse /
energy efficiency class:

A+

Markenleuchtmittel inkl.
branded lamp incl.

↓ 28 cm, ↗ 13 cm



17W
1160
Lumen

4 Kelton / Serie 017
3017.02.54.0000
EAN4003474299495
Nickel-matt/Chrom /
Nickel matt finished/Chrome

 17 W LED incl.
3000 K / 1160 lm

Energieeffizienzklasse /
energy efficiency class:

A

Markenleuchtmittel inkl.
branded lamp incl.

↓ 143,5 cm, ↔ 22 cm, ↗ 22 cm



1 Louvre / Serie 825
7825.01.54.1000
 EAN4003474291208
 Nickel-matt / Chrom /
 Nickel matt finished / Chrome

 1 x LED / 16,2 W incl.
 3000 K / 1 x 1132 lm

Energieeffizienzklasse /
 energy efficiency class:

A

Markenleuchtmittel inkl.
 branded lamp incl.

↓ 150 cm, ↔ 112 cm, ↗ 7 cm

Dimmbar mittels geeignetem
 Wanddimmer / dimmable by
 suitable wall dimmer



16,2W

1132
 Lumen



20W

1400
 Lumen

3 Louvre / Serie 825
8825.01.54.0000
 EAN4003474274157
 Nickel-matt / Chrom /
 Nickel matt finished / Chrome

 1 x LED / 20 W incl.
 3000 K / 1 x 1400 lm

Energieeffizienzklasse /
 energy efficiency class:

A

Markenleuchtmittel inkl.
 branded lamp incl.

↓ 58,5 cm, ↔ 18 cm



50W

3500
 Lumen

4 Louvre / Serie 825
3825.01.54.0000
 EAN4003474274126
 Nickel-matt / Chrom /
 Nickel matt finished / Chrome

 1 x LED / 50 W incl.
 3000 K / 1 x 3500 lm

Energieeffizienzklasse /
 energy efficiency class:

A

Markenleuchtmittel inkl.
 branded lamp incl.

↓ 145 cm, ↔ 24 cm



LED Light
 by **WOFI**

2 Louvre / Serie 825
7825.01.54.0000
 EAN4003474274140
 Nickel-matt / Chrom /
 Nickel matt finished / Chrome

 1 x LED / 40 W incl.
 3000 K / 1 x 2700 lm

Energieeffizienzklasse /
 energy efficiency class:

A

Markenleuchtmittel inkl.
 branded lamp incl.

↔ 111,5 cm, ↓ 150 cm

Dimmbar mittels geeignetem
 Wanddimmer / dimmable by
 suitable wall dimmer



40W

2700
 Lumen



10W

700
 Lumen

5 Louvre / Serie 825
9825.01.54.0000
 EAN4003474274560
 Nickel-matt / Chrom /
 Nickel matt finished / Chrome

 1 x LED / 10 W incl.
 3000 K / 1 x 700 lm

Energieeffizienzklasse /
 energy efficiency class:

A

Markenleuchtmittel inkl.
 branded lamp incl.

↓ 10,5 cm, ↔ 58 cm



10W

700
 Lumen

6 Louvre / Serie 825
4825.01.54.0000
 EAN4003474274133
 Nickel-matt / Chrom /
 Nickel matt finished / Chrome

 1 x LED / 10 W incl.
 3000 K / 1 x 700 lm

Energieeffizienzklasse /
 energy efficiency class:

A

Markenleuchtmittel inkl.
 branded lamp incl.

↔ 29 cm, ↓ 13 cm, ↗ 7 cm



LED Light
by **WOFI**



1 Trois / Serie 809
9809.01.01.0000
EAN4003474301754
Chrom / Chrome

Markenleuchtmittel inkl.
branded lamp incl.

↔ 96 cm, ↗ 17 cm, ⊥ 7,5 cm

25W
1660 Lumen

1 x LED / 25 W incl.
3000 K / 1 x 1660 lm

Energieeffizienzklasse /
energy efficiency class:

A

Dimmbar mittels geeignetem
Wanddimmer / *dimmable by*
suitable wall dimmer

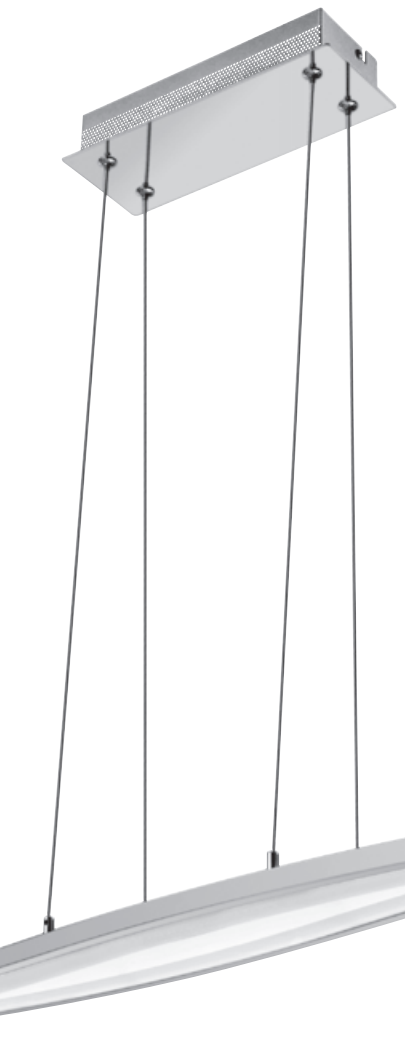
25W
1660 Lumen

4 Trois / Serie 809
7809.01.01.0000
EAN4003474301716
Chrom / Chrome

1 x LED / 25 W incl.
3000 K / 1 x 1660 lm

Energieeffizienzklasse /
energy efficiency class:

A

Markenleuchtmittel inkl.
branded lamp incl.

⌈ 150 cm, ↔ 96 cm, ↗ 16 cm

Dimmbar mittels geeignetem
Wanddimmer / *dimmable by*
suitable wall dimmer



5 Trois / Serie 809
3809.01.01.0000
EAN4003474301792
Chrom / Chrome

1 x LED / 34 W incl.
3000 K / 1 x 2260 lm

Energieeffizienzklasse /
energy efficiency class:

A

Markenleuchtmittel inkl.
branded lamp incl.

⌈ 131,5 cm, ↔ 20 cm

3-Stufen dimmbar
3-step dimmable



Neu!
New!



10W
660 Lumen

2 Trois / Serie 809
8809.01.01.0000
EAN4003474303161
Chrom / Chrome

1 x LED / 10 W incl.
3000 K / 1 x 660 lm

Energieeffizienzklasse /
energy efficiency class:

A

Markenleuchtmittel inkl.
branded lamp incl.

Ø 12 cm, ⌈ 40,5 cm

3-Stufen dimmbar
3-step dimmable



3 Trois / Serie 809
4809.01.01.0000
EAN4003474301730
Chrom / Chrome

1 x LED / 6,5 W incl.
3000 K / 1 x 450 lm

Energieeffizienzklasse /
energy efficiency class:

A

Markenleuchtmittel inkl.
branded lamp incl.

⌈ 31,5 cm, ↔ 11,5 cm, ⊥ 5,5 cm



6,5W
450 Lumen



24W
1700
Lumen

1 Avignon / Serie 275
7275.01.64.0000
EAN4003474281520
Nickel-matt /
Nickel matt finished



1 x LED / 24 W incl.
3000 K / 1 x 1700 lm

Energieeffizienzklasse /
energy efficiency class:

A

Markenleuchtmittel inkl.
branded lamp incl.

↓ 150 cm, ↔ 80 cm, ↗ 15 cm

Glas / Glass: 1040, ↔ 80 cm

Dimmbar mittels geeignetem
Wanddimmer / dimmable by
suitable wall dimmer



2 Avignon / Serie 275
8275.01.64.0000
EAN4003474281544
Nickel-matt /
Nickel matt finished



1 x LED / 12 W incl.
3000 K / 1 x 700 lm

Energieeffizienzklasse /
energy efficiency class:

A

Markenleuchtmittel inkl.
branded lamp incl.

↓ 37,6 cm, ↔ 11 cm, ↗ 11 cm

Glas / Glass: 3001,
↓ 37 cm, ↔ 8 cm



3-Stufen dimmbar
3-step dimmable

12W
700
Lumen

LED Light
by **WOFI**



3 Avignon / Serie 275
4275.01.64.0000
EAN4003474281513
Nickel-matt /
Nickel matt finished



1 x LED / 6,6 W incl.
3000 K / 1 x 450 lm

Energieeffizienzklasse /
energy efficiency class:

A

Markenleuchtmittel inkl.
branded lamp incl.

↓ 30 cm, ↔ 4,5 cm, ⇨ 8 cm

Glas / Glass: 1426,
↓ 30,5 cm, ↔ 8 cm



6,6W
450
Lumen

New!
New!

Sternenlicht wie aus einer fernen Galaxie

...Starlight from a far galaxy



22W
1600
Lumen

1 Galax / Serie 587
7587.01.01.0000
EAN4003474301921
Chrom / Chrome

 1 x LED / 22 W incl.
3000 K / 1 x 1600 lm

Energieeffizienzklasse /
energy efficiency class:

A

Markenleuchtmittel inkl.
branded lamp incl.

↓ 150 cm, ↔ 100 cm, ↗ 30 cm

Dimmbar mittels geeignetem
Wanddimmer / dimmable by
suitable wall dimmer





2 Galax / Serie 587
9587.01.01.0000
 EAN4003474305929
 Chrom / Chrome



1 x LED / 22 W incl.
 3000 K / 1 x 1600 lm

Energieeffizienzklasse /
 energy efficiency class:



Markenleuchtmittel inkl.
 branded lamp incl.

↔ 100 cm, ⊥ 9 cm

Dimmbar mittels geeignetem
 Wanddimmer / dimmable by
 suitable wall dimmer



LED Light
 by **WOFI**

3 Galax / Serie 587
3587.01.01.0000
 EAN4003474301914
 Chrom / Chrome



1 x LED / 26 W incl.
 3000 K / 1 x 1860 lm

Energieeffizienzklasse /
 energy efficiency class:



Markenleuchtmittel inkl.
 branded lamp incl.

⌈ 124 cm, ↔ 20 cm, ↗ 20 cm



3-Stufen dimmbar
 3-step dimmable



4 Galax / Serie 587
8587.01.01.0000
 EAN4003474301907
 Chrom / Chrome



1 x LED / 11,5 W incl.
 3000 K / 1 x 800 lm

Energieeffizienzklasse /
 energy efficiency class:



Markenleuchtmittel inkl.
 branded lamp incl.

⌈ 43 cm, ↔ 12 cm, ↗ 12 cm



3-Stufen dimmbar
 3-step dimmable



5 Galax / Serie 587
4587.01.01.0000
 EAN4003474246857
 Chrom / Chrome



1 x LED / 10,5 W incl.
 3000 K / 1 x 680 lm

Energieeffizienzklasse /
 energy efficiency class:



Markenleuchtmittel inkl.
 branded lamp incl.

⌈ 40,5 cm, ↔ 8,5 cm, ⊥ 10 cm



3-Stufen dimmbar
 3-step dimmable



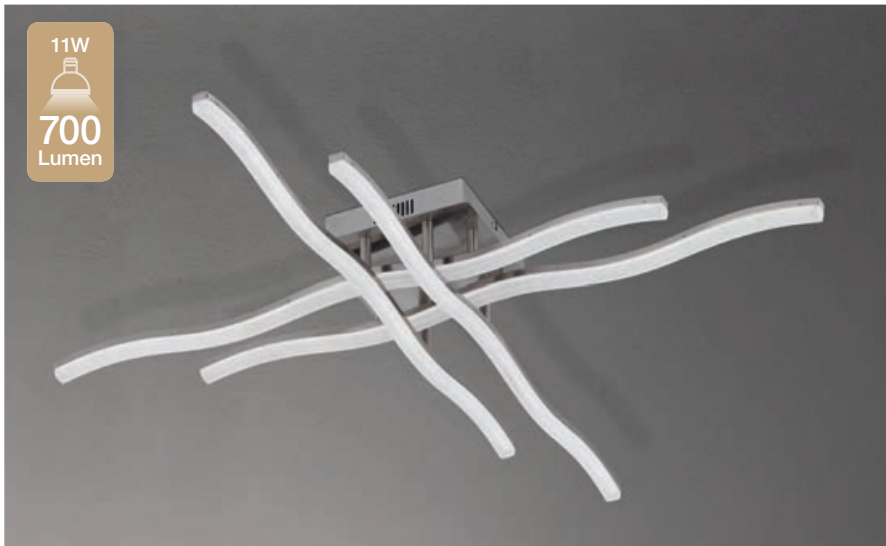

11W
700
Lumen

4 Kennett / Serie 770
3770.01.64.0000
EAN4003474304595
Nickel-matt /
Nickel matt finished



1 x LED / 27 W incl.
3000 K / 1 x 1800 lm

Energieeffizienzklasse /
energy efficiency class:

A

Markenleuchtmittel inkl.
branded lamp incl.

↓ 126,5 cm, ↔ 18 cm



27W
1800
Lumen



11W
700
Lumen

5 Kennett / Serie 770
9770.02.64.0000
EAN4003474304601
Nickel-matt /
Nickel matt finished



2 x LED / 11 W incl.
3000 K / 2 x 700 lm

Energieeffizienzklasse /
energy efficiency class:

A

Markenleuchtmittel inkl.
branded lamp incl.

↔ 96 cm, ↓ 9,5 cm

Dimmbar mittels geeignetem
Wanddimmer / dimmable by
suitable wall dimmer



1 Kennett / Serie 770
9770.04.64.0000
EAN4003474304618
Nickel-matt /
Nickel matt finished



4 x LED / 11 W incl.
3000 K / 4 x 700 lm

Energieeffizienzklasse /
energy efficiency class:

A

Markenleuchtmittel inkl.
branded lamp incl.

↔ 96 cm, ↗ 96 cm, ↓ 12,5 cm

Dimmbar mittels geeignetem
Wanddimmer / dimmable by
suitable wall dimmer



Klares Design sorgt für klare Lichtverhältnisse

...sleek design for clear, crisp light

LED Light
by **WOFI**

2 Kennett / Serie 770
4770.01.64.0000
EAN4003474301693
Nickel-matt /
Nickel matt finished



1 x LED / 7,2 W incl.
3000 K / 1 x 560 lm

Energieeffizienzklasse /
energy efficiency class:

A+

Markenleuchtmittel inkl.
branded lamp incl.

↓ 35 cm, ↔ 7,5 cm



7,2W
560
Lumen



11W
700
Lumen

3 Kennett / Serie 770
8770.01.64.0000
EAN4003474304588
Nickel-matt /
Nickel matt finished



1 x LED / 11 W incl.
3000 K / 1 x 700 lm

Energieeffizienzklasse /
energy efficiency class:

A

Markenleuchtmittel inkl.
branded lamp incl.

↓ 44,5 cm, ↔ 10 cm



Neu!
New!

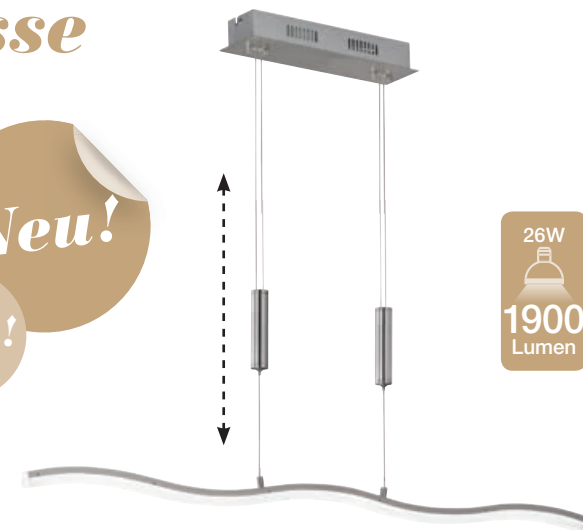

26W
1900
Lumen

6 Kennett / Serie 770
7770.01.64.0000
EAN4003474304625
Nickel-matt /
Nickel matt finished



1 x LED / 26 W incl.
3000 K / 1 x 1900 lm

Energieeffizienzklasse /
energy efficiency class:

A

Markenleuchtmittel inkl.
branded lamp incl.

↓ 150 cm, ↔ 100 cm

Dimmbar mittels geeignetem
Wanddimmer / dimmable by
suitable wall dimmer





1 Sorel / Serie 524
4524.01.01.0000
EAN4003474296432
Chrom / Chrome

6W
430 Lumen

Markenleuchtmittel inkl.
branded lamp incl.

↑ 7,5 cm, ↔ 32 cm, ↗ 7 cm

1 x LED / 6 W incl.
3000 K / 1 x 430 lm

3-Stufen dimmbar
3-step dimmable

Energieeffizienzklasse /
energy efficiency class:
A+

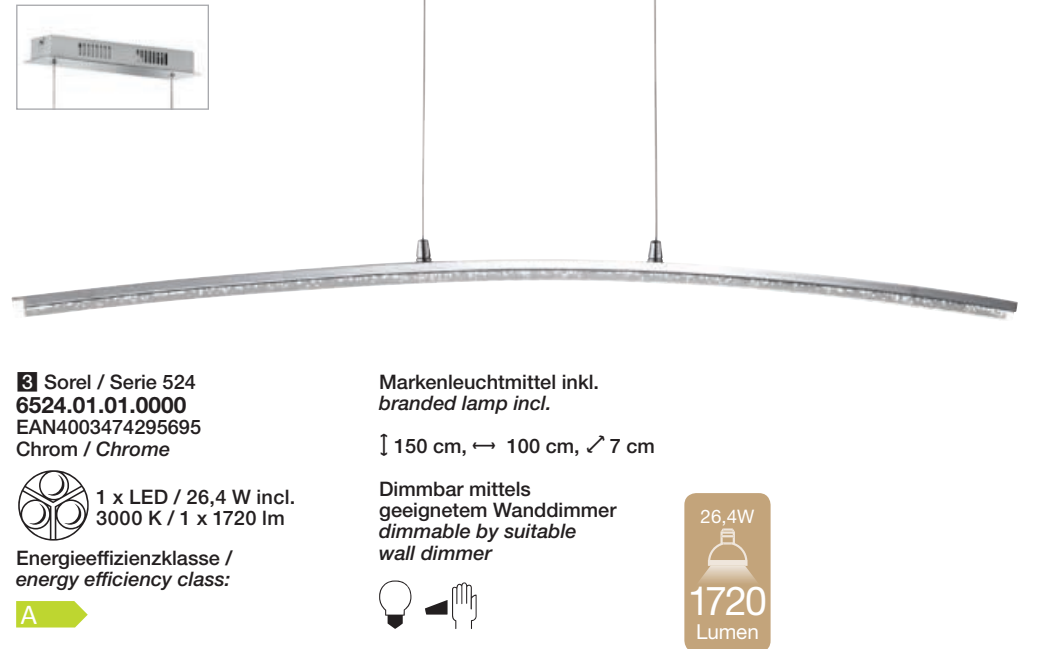

3 Sorel / Serie 524
6524.01.01.0000
EAN4003474295695
Chrom / Chrome

1 x LED / 26,4 W incl.
3000 K / 1 x 1720 lm

Markenleuchtmittel inkl.
branded lamp incl.

↑ 150 cm, ↔ 100 cm, ↗ 7 cm

Dimmbar mittels
geeignetem Wanddimmer
dimmable by suitable
wall dimmer

26,4W
1720 Lumen

Energieeffizienzklasse /
energy efficiency class:
A

Extravaganz in neuer Form

...A new form of extravagance



36W
2450 Lumen

LED Light
by **WOFI**

2 Sorel / Serie 524
9524.08.01.0000
EAN4003474295718
Chrom / Chrome

36 W LED incl.
3000 K / 2450 lm

Energieeffizienzklasse /
energy efficiency class:
A

Markenleuchtmittel inkl.
branded lamp incl.

↑ 76 cm, ↔ 76 cm, ⊥ 8,5 cm

Neu!

Neu!



24W
1820 Lumen

4 Sorel / Serie 524
3524.01.01.0000
EAN4003474295688
Chrom / Chrome

1 x LED / 24 W incl.
3000 K / 1 x 1820 lm

Energieeffizienzklasse /
energy efficiency class:
A

Markenleuchtmittel inkl.
branded lamp incl.

↑ 130,5 cm, ↔ 18 cm, ↗ 18 cm

3-Stufen dimmbar
3-step dimmable



11W
700 Lumen

5 Sorel / Serie 524
8524.01.01.0000
EAN4003474295671
Chrom / Chrome

1 x LED / 11 W incl.
3000 K / 1 x 700 lm

Energieeffizienzklasse /
energy efficiency class:
A

Markenleuchtmittel inkl.
branded lamp incl.

↑ 43,5 cm, ↔ 10 cm, ↗ 10 cm

3-Stufen dimmbar
3-step dimmable



12W
960
Lumen

1 Napa / Serie 666
6666.01.64.0000
EAN4003474295572
Nickel-matt /
Nickel matt finished



1 x LED / 12 W incl.
3000 K / 1 x 960 lm

Energieeffizienzklasse /
energy efficiency class:

A

Markenleuchtmittel inkl.
branded lamp incl.

↓ 150 cm, ↔ 100 cm, ↗ 8 cm

4,3W
300
Lumen

LED Light
by **WOLFF**



2 Napa / Serie 666
9666.04.64.0000
EAN4003474297514
Nickel-matt /
Nickel matt finished



4 x LED / 4,3 W incl.
3000 K / 4 x 300 lm

Energieeffizienzklasse /
energy efficiency class:

A+

Markenleuchtmittel inkl.
branded lamp incl.

↔ 69,5 cm, ↓ 7 cm

16W
1100
Lumen

7W
520
Lumen



Für jeden Raum das richtige Licht

...Perfect light for every room

3 Napa / Serie 666
8666.01.64.0000
EAN4003474295510
Nickel-matt /
Nickel matt finished



1 x LED / 7 W incl.
3000 K / 1 x 520 lm

Energieeffizienzklasse /
energy efficiency class:

A+

Markenleuchtmittel inkl.
branded lamp incl.

↓ 46 cm, ↔ 13 cm, ↗ 13 cm



Ausdrucksstarke Leuchten für
leidenschaftliche Design-Fans

The perfect light for those
passionate about design

Neu!
New!

4 Napa / Serie 666
3666.01.64.0000
EAN4003474295503
Nickel-matt /
Nickel matt finished



1 x LED / 16 W incl.
3000 K / 1 x 1100 lm

Energieeffizienzklasse /
energy efficiency class:

A

Markenleuchtmittel inkl.
branded lamp incl.

↓ 150 cm, ↔ 19 cm, ↗ 37 cm





4W
300
Lumen

LED Light
by WOFI®

12W
800
Lumen

Neu!
Neu!

1 Horton / Serie 786
9786.06.54.0000
EAN4003474303840
Nickel-matt/Chrom /
Nickel matt finished/Chrome

6 x LED / 4 W incl.
3000 K / 6 x 300 lm

Energieeffizienzklasse /
energy efficiency class:

A

Markenleuchtmittel inkl.
branded lamp incl.

Ø 79,5 cm, 8 cm

Elegante Raumwunder

...Elegant space savers

2 Horton / Serie 786
8786.01.54.0000
EAN4003474304229
Nickel-matt/Chrom /
Nickel matt finished/Chrome

1 x LED / 4 W incl.
3000 K / 1 x 260 lm

Energieeffizienzklasse /
energy efficiency class:

A+

Markenleuchtmittel inkl.
branded lamp incl.

38 cm, 14,5 cm, 9 cm

4W
260
Lumen

3 Horton / Serie 786
7786.01.54.0000
EAN4003474306292
Nickel-matt/Chrom /
Nickel matt finished/Chrome

1 x LED / 12 W incl.
3000 K / 1 x 800 lm

Energieeffizienzklasse /
energy efficiency class:

A

Markenleuchtmittel inkl.
branded lamp incl.

150 cm, 100 cm, 5,5 cm

14W
900
Lumen

4 Horton / Serie 786
3786.01.54.0000
EAN4003474303895
Nickel-matt/Chrom /
Nickel matt finished/Chrome

1 x LED / 14 W incl.
3000 K / 1 x 900 lm

Energieeffizienzklasse /
energy efficiency class:

A

Markenleuchtmittel inkl.
branded lamp incl.

151 cm, 24 cm, 12 cm



1 Logan / Serie 175

7175.05.01.0000
EAN4003474282879
Chrom / Chrome

 5 x LED / 4,2 W incl.
3000 K / 5 x 270 lm

Energieeffizienzklasse /
energy efficiency class:

A+

Markenleuchtmittel inkl.
branded lamp incl.

↑ 150 cm, ↔ 93 cm, ↗ 7 cm

Dimmbar mittels geeignetem
Wanddimmer / dimmable by
suitable wall dimmer



4,2W

270
Lumen



3 Logan / Serie 175

9175.09.01.0000
EAN4003474286402
Chrom / Chrome

 9 x LED / 4,2 W incl.
3000 K / 9 x 270 lm

Energieeffizienzklasse /
energy efficiency class:

A+

Markenleuchtmittel inkl.
branded lamp incl.

↑ 42 cm, ↔ 42 cm, ↓ 8 cm

Glas / Glass: 6587

Dimmbar mittels geeignetem
Wanddimmer / dimmable by
suitable wall dimmer



4,2W

270
Lumen



*Licht in seiner
schönsten Form*
...light in its most beautiful form



44W

3000
Lumen

2 Soul / Serie 117

9117.01.54.0000
EAN4003474291031
Nickel-matt / Chrom /
Nickel matt finished / Chrome

 1 x LED / 44 W incl.
3000 K / 1 x 3000 lm

Energieeffizienzklasse /
energy efficiency class:

A

Markenleuchtmittel inkl.
branded lamp incl.

↔ 61 cm, ↗ 55 cm, ↓ 6,5 cm

Dimmbar mittels geeignetem
Wanddimmer / dimmable by
suitable wall dimmer



4 Logan / Serie 175

9175.04.01.0000
EAN4003474286396
Chrom / Chrome

 4 x LED / 4,2 W incl.
3000 K / 4 x 270 lm

Energieeffizienzklasse /
energy efficiency class:

A+

Markenleuchtmittel inkl.
branded lamp incl.

↑ 27,5 cm, ↔ 27,5 cm, ↓ 8 cm

Glas / Glass: 6587

Dimmbar mittels geeignetem
Wanddimmer / dimmable by
suitable wall dimmer





6W
450
Lumen

1 Hook / Serie 893
7893.04.54.1000
EAN4003474302515
Nickel-matt/Chrom /
Nickel matt finished/Chrome

Markenleuchtmittel inkl.
branded lamp incl.
↓ 150 cm, ← 82 cm, ↗ 34 cm
Glas / Glass: 6316

4 x LED / 6 W incl.
3000 K / 4 x 450 lm

Energieeffizienzklasse /
energy efficiency class:

A

Dimmbar mittels geeignetem
Wanddimmer / dimmable by
suitable wall dimmer



6W
450
Lumen



2 Hook / Serie 893
7893.06.54.0000
EAN4003474305691
Nickel-matt/Chrom /
Nickel matt finished/Chrome

Markenleuchtmittel inkl.
branded lamp incl.
↓ 150 cm, ← 130 cm, ↗ 34 cm
Glas / Glass: 6316

6 x LED / 6 W incl.
3000 K / 6 x 450 lm

Energieeffizienzklasse /
energy efficiency class:

A

Dimmbar mittels geeignetem
Wanddimmer / dimmable by
suitable wall dimmer



LED Light
by WOFI®



8W
600
Lumen

3 Hook / Serie 893
3893.03.54.0000
EAN4003474304045
Nickel-matt/Chrom /
Nickel matt finished/Chrome

3 x LED / 8 W incl.
3000 K / 3 x 600 lm

Energieeffizienzklasse /
energy efficiency class:

A

Markenleuchtmittel inkl.
branded lamp incl.

↓ 140 cm, ← 28,5 cm

Glas / Glass: 6316

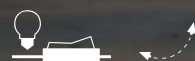

4 Hook / Serie 893
9893.03.54.0000
EAN4003474304007
Nickel-matt/Chrom /
Nickel matt finished/Chrome

3 x LED / 8 W incl.
3000 K / 3 x 600 lm

Energieeffizienzklasse /
energy efficiency class:

A

Markenleuchtmittel inkl.
branded lamp incl.

Ø 30 cm, ↓ 20 cm

Glas / Glass: 6316

Weitere Leuchten zu
dieser Serie finden Sie
auf Seite 112

You'll find matching
products on page 112



8W
600
Lumen

Neu!
Neu!

5 Hook / Serie 893
8893.01.54.0000
EAN4003474304038
Nickel-matt/Chrom /
Nickel matt finished/Chrome

1 x LED / 8 W incl.
3000 K / 1 x 600 lm

Energieeffizienzklasse /
energy efficiency class:

A

Markenleuchtmittel inkl.
branded lamp incl.

↓ 39 cm, ← 22 cm

Glas / Glass: 6316



8W
600
Lumen

1 Davis / Serie 507
7507.04.54.1000
 EAN4003474303079
 Nickel-matt / Chrom /
 Nickel matt finished / Chrome

 4 x LED / 5 W incl.
 3000 K / 4 x 400 lm

Energieeffizienzklasse /
 energy efficiency class:

A

Markenleuchtmittel inkl.
 branded lamp incl.

↓ 150 cm, ↔ 85 cm, ↗ 12,5 cm

Glas / Glass: 1158



LED Light
 by **WOFI**

5W

 400
 Lumen



2 Davis / Serie 507
3507.04.54.0000
 EAN4003474303055
 Nickel-matt / Chrom / Nickel
 matt finished / Chrome

 4 x LED / 5 W incl.
 3000 K / 4 x 400 lm

Energieeffizienzklasse /
 energy efficiency class:

A

Markenleuchtmittel inkl.
 branded lamp incl.

↓ 135 cm, ↔ 18 cm

Glas / Glass: 1158



Neu!

Neu!

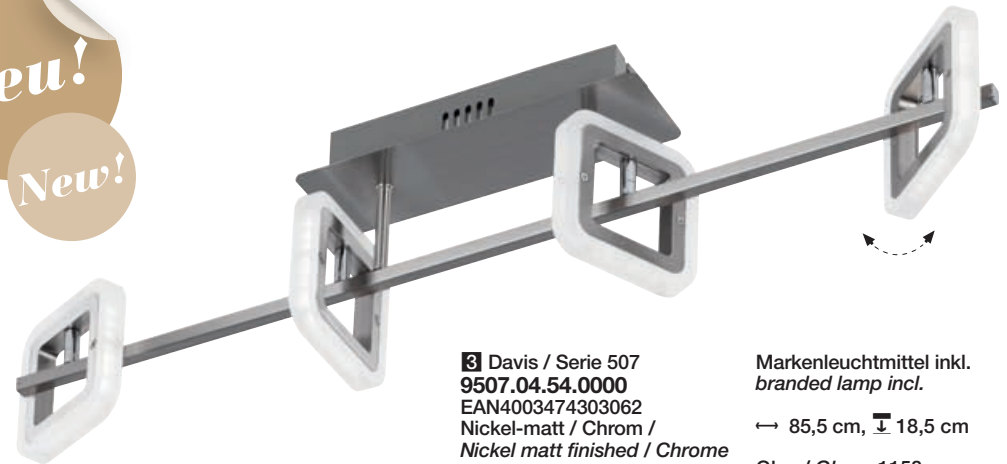

3 Davis / Serie 507
9507.04.54.0000
 EAN4003474303062
 Nickel-matt / Chrom /
 Nickel matt finished / Chrome

 4 x LED / 5 W incl.
 3000 K / 4 x 400 lm

Energieeffizienzklasse /
 energy efficiency class:

A

Markenleuchtmittel inkl.
 branded lamp incl.

↔ 85,5 cm, ↓ 18,5 cm

Glas / Glass: 1158



*Ganz schön
 flexibel*
 ...Light without limits



4 Davis / Serie 507
8507.01.54.0000
 EAN4003474303086
 Nickel-matt / Chrom /
 Nickel matt finished / Chrome

 1 x LED / 5 W incl.
 3000 K / 1 x 400 lm

Energieeffizienzklasse /
 energy efficiency class:

A+

Markenleuchtmittel inkl.
 branded lamp incl.

↓ 30 cm, ↔ 12,5 cm

Glas / Glass: 1158



5 Davis / Serie 507
4507.01.54.0000
 EAN4003474302997
 Nickel-matt / Chrom /
 Nickel matt finished / Chrome

 1 x LED / 5 W incl.
 3000 K / 1 x 400 lm

Energieeffizienzklasse /
 energy efficiency class:

A+

Markenleuchtmittel inkl.
 branded lamp incl.

↓ 12,5 cm, ↔ 12,5 cm, ↗ 10,5 cm

Glas / Glass: 1158



LED Light
by **WOFI**

9W
900
Lumen

Neu!
Neu!



1 Segura / Serie 161
9161.01.76.0000
EAN4003474301075
Nickel-matt eloxiert /
Nickel matt finished anodised



1 x LED / 9 W incl.
3000 K / 1 x 900 lm

Energieeffizienzklasse /
energy efficiency class:

A+

Markenleuchtmittel inkl.
branded lamp incl.

∓ 44,5 cm, ↔ 65,5 cm, ↗ 14 cm

2 Segura / Serie 162
7162.03.76.0000
EAN4003474303147
Nickel-matt eloxiert /
Nickel matt finished
anodised



3 x LED / 12 W incl.
3000 K / 3 x 950 lm

Energieeffizienzklasse /
energy efficiency class:

A

Markenleuchtmittel inkl.
branded lamp incl.

∓ 150 cm, ↔ 118,5 cm,
↗ 10,5 cm

Dimmbar mittels
geeignetem Wanddimmer
dimmable by
suitable wall dimmer



12W
950
Lumen

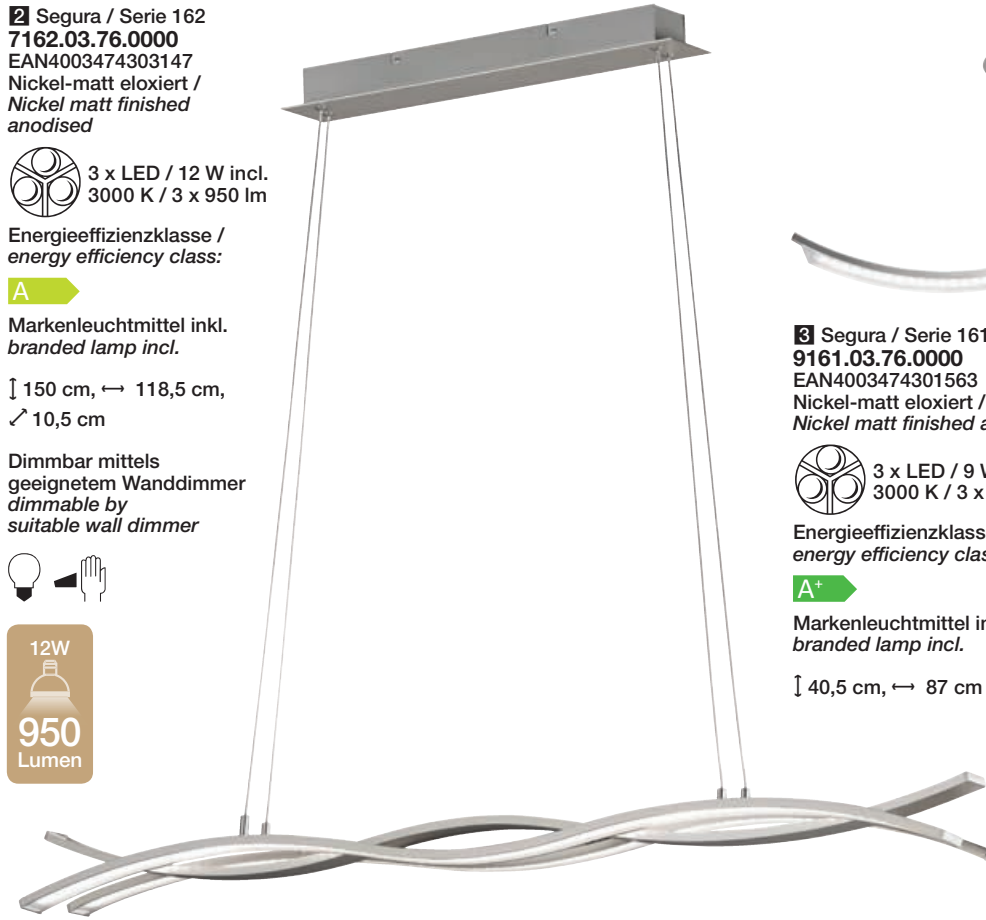

9W
900
Lumen

3 Segura / Serie 161
9161.03.76.0000
EAN4003474301563
Nickel-matt eloxiert /
Nickel matt finished anodised



3 x LED / 9 W incl.
3000 K / 3 x 900 lm

Energieeffizienzklasse /
energy efficiency class:

A+

Markenleuchtmittel inkl.
branded lamp incl.

∓ 40,5 cm, ↔ 87 cm

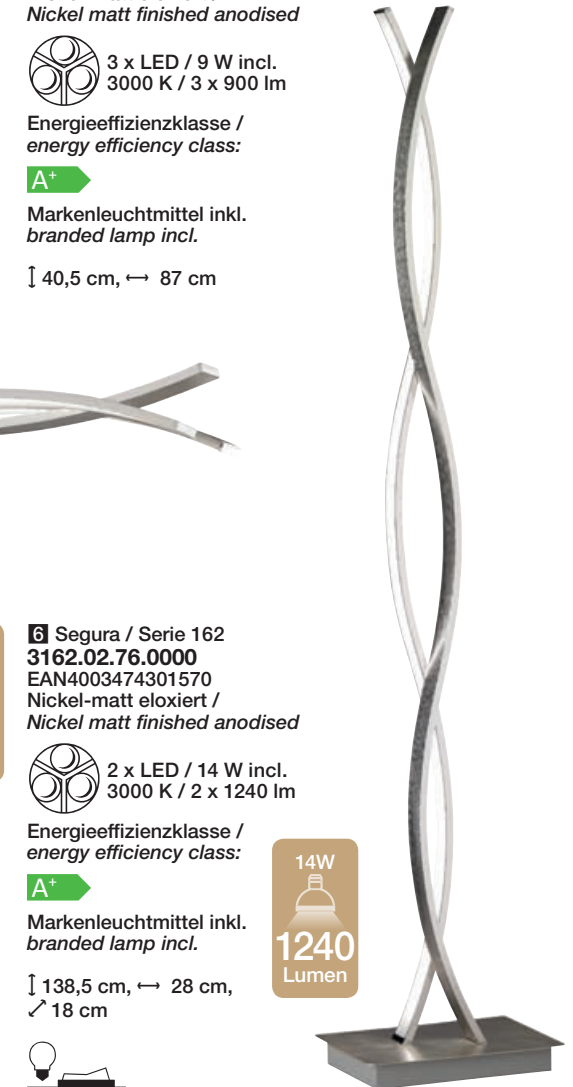

5W
410
Lumen



4 Segura / Serie 162
8162.02.76.0000
EAN4003474301525
Nickel-matt eloxiert /
Nickel matt finished anodised



2 x LED / 5 W incl.
3000 K / 2 x 410 lm

Energieeffizienzklasse /
energy efficiency class:

A+

Markenleuchtmittel inkl.
branded lamp incl.

∓ 53,5 cm, ↔ 20 cm, ↗ 12 cm



5 Segura / Serie 161
8161.01.76.0000
EAN4003474301549
Nickel-matt eloxiert /
Nickel matt finished anodised



1 x LED / 8 W incl.
3000 K / 1 x 800 lm

Energieeffizienzklasse /
energy efficiency class:

A+

Markenleuchtmittel inkl.
branded lamp incl.

∓ 30 cm, ↔ 41,5 cm, ↗ 14 cm



8W
800
Lumen

6 Segura / Serie 162
3162.02.76.0000
EAN4003474301570
Nickel-matt eloxiert /
Nickel matt finished anodised



2 x LED / 14 W incl.
3000 K / 2 x 1240 lm

Energieeffizienzklasse /
energy efficiency class:

A+

Markenleuchtmittel inkl.
branded lamp incl.

∓ 138,5 cm, ↔ 28 cm,
↗ 18 cm



14W
1240
Lumen

LED Light
by WOFI®

1 Luz / Serie 682
3682.01.01.0500
EAN4003474264493
Chrom / Chrome

1 x LED / 30 W incl.
3000 K / 1 x 3000 lm

Energieeffizienzklasse /
energy efficiency class:

A+

Markenleuchtmittel inkl.
branded lamp incl.

↑ 185 cm, ↳ 102,5 cm

3-Stufen dimmbar
3-step dimmable

16,8W
1680
Lumen

Die haben den Bogen raus ...Convenient curves

2 Luz / Serie 682
3682.01.01.0000
EAN4003474259598
Chrom / Chrome

1 x LED / 16,8 W incl.
3000 K / 1 x 1680 lm

Energieeffizienzklasse /
energy efficiency class:

A+

Markenleuchtmittel inkl.
branded lamp incl.

↑ 165 cm, ↳ 48 cm, ↗ 16,5 cm

3-Stufen dimmbar
3-step dimmable

3 Luz / Serie 682
8682.01.01.0000
EAN4003474259604
Chrom / Chrome

1 x LED / 9,6 W incl.
3000 K / 1 x 770 lm

Energieeffizienzklasse /
energy efficiency class:

A+

Markenleuchtmittel inkl.
branded lamp incl.

↑ 40 cm, ↳ 30 cm, ↗ 10 cm

3-Stufen dimmbar
3-step dimmable

9,6W
770
Lumen

30W
3000
Lumen



25W
1750
Lumen

1 Luz / Serie 682
7682.01.64.1200
EAN4003474289496
Nickel-matt / Nickel matt finished

Markenleuchtmittel inkl.
branded lamp incl.

↓ 150 cm, ↔ 120 cm, ↗ 6 cm

1 x LED / 25 W incl.
3000 K / 1 x 1750 lm

Dimmbar mittels geeignetem
Wanddimmer / dimmable by
suitable wall dimmer

Energieeffizienzklasse /
energy efficiency class:

A



9,6W
770
Lumen

2 Luz / Serie 682
8682.01.64.0000
EAN4003474279855
Nickel-matt /
Nickel matt finished

1 x LED / 9,6 W incl.
3000 K / 1 x 770 lm

Energieeffizienzklasse /
energy efficiency class:

A+

Markenleuchtmittel inkl.
branded lamp incl.

↓ 40 cm, ↗ 10 cm, ↳ 30 cm

3-Stufen dimmbar
3-step dimmable



16,8W
1680
Lumen

LED Light
by WOFI

3 Luz / Serie 682
3682.01.64.0000
EAN4003474279213
Nickel-matt /
Nickel matt finished

Markenleuchtmittel inkl.
branded lamp incl.

↓ 165 cm, ↳ 48 cm

1 x LED / 16,8 W incl.
3000 K / 1 x 1680 lm

Energieeffizienzklasse /
energy efficiency class:

A+



3-Stufen dimmbar
3-step dimmable

7,2W
504
Lumen



25W
1750
Lumen

4 Mercur / Serie 313
7313.01.01.0000
EAN4003474268569
Chrom / Chrome

Markenleuchtmittel inkl.
branded lamp incl.

↓ 150 cm, ↔ 94 cm, ↓ 8 cm

1 x LED / 25 W incl.
3000 K / 1 x 1750 lm

Dimmbar mittels geeignetem
Wanddimmer / dimmable by
suitable wall dimmer

Energieeffizienzklasse /
energy efficiency class:

A



4,8W
336
Lumen

5 Mercur / Serie 313
4313.01.01.0000
EAN4003474268552
Chrom / Chrome

1 x LED / 4,8 W incl.
3000 K / 1 x 336 lm

Energieeffizienzklasse /
energy efficiency class:

A+

Markenleuchtmittel inkl.
branded lamp incl.

↓ 28 cm, ↔ 10 cm,
↳ 14 cm



6 Mercur / Serie 313
8313.01.01.0000
EAN4003474268576
Chrom / Chrome

Markenleuchtmittel inkl.
branded lamp incl.

↓ 40 cm, ↔ 12 cm, ↳ 48 cm

1 x LED / 7,2 W incl.
3000 K / 1 x 504 lm

Energieeffizienzklasse /
energy efficiency class:

A

3-Stufen dimmbar
3-step dimmable



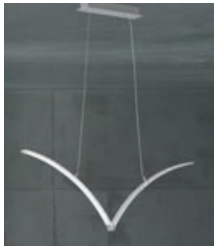

Neu!
Neu!

Bringt Schwung in jeden Raum
...gives drive to every room



12W
900
Lumen

1 Banks / Serie 404
7404.02.76.0000
EAN4003474305813
Nickel-matt eloxiert /
Nickel matt finished anodised



2 x LED / 12 W incl.
3000 K / 2 x 900 lm

Energieeffizienzklasse /
energy efficiency class:

A+

Markenleuchtmittel inkl.
branded lamp incl.

∟ 150 cm, ↔ 112 cm, ↗ 7,5 cm



LED Light
by **WOFI**

8W
800
Lumen

2 Banks / Serie 404
8404.01.76.0000
EAN4003474305820
Nickel-matt eloxiert /
Nickel matt finished anodised



1 x LED / 8 W incl.
3000 K / 1 x 800 lm

Energieeffizienzklasse /
energy efficiency class:

A

Markenleuchtmittel inkl.
branded lamp incl.

∟ 46 cm, ↔ 40,5 cm, ↗ 11 cm



3 Banks / Serie 404
3404.01.76.0000
EAN4003474305806
Nickel-matt eloxiert /
Nickel matt finished anodised



1 x LED / 16 W incl.
3000 K / 1 x 1280 lm

Energieeffizienzklasse /
energy efficiency class:

A

Markenleuchtmittel inkl.
branded lamp incl.

∟ 120 cm, ↔ 75 cm, ↗ 18 cm



16W
1280
Lumen



New!
New!

20W
1500
Lumen

1 Camp / Serie 448
3448.03.01.0000
EAN4003474304564
Chrom / Chrome

LED 20 W incl.
3000 K / 1500 lm

Energieeffizienzklasse /
energy efficiency class:

A

Markenleuchtmittel inkl. /
branded lamp incl.

↑ 156 cm, ↔ 25 cm



10W
700
Lumen

2 Camp / Serie 448
8448.03.01.0000
EAN4003474301877
Chrom / Chrome

LED 10 W incl.
3000 K / 700 lm

Energieeffizienzklasse /
energy efficiency class:

A

Markenleuchtmittel inkl. /
branded lamp incl.

↑ 51 cm, ↔ 17 cm

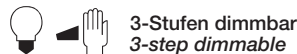

3 Montreal / Serie 394
9394.04.54.0000
EAN4003474300221
Nickel-matt / Chrom /
Nickel matt finished / Chrome



4 x LED / 5,8 W incl.
3000 K / 4 x 360 lm

Energieeffizienzklasse /
energy efficiency class:

A

Markenleuchtmittel inkl. /
branded lamp incl.

↔ 77 cm, ↗ 9 cm, ↓ 20,5 cm



5,8W
360
Lumen



4 Montreal / Serie 394
9394.08.54.0000
EAN4003474302355
Nickel-matt / Chrom /
Nickel matt finished / Chrome



8 x LED / 3,8 W incl.
3000 K / 8 x 240 lm

Energieeffizienzklasse /
energy efficiency class:

A

Markenleuchtmittel inkl. /
branded lamp incl.

↔ 106,5 cm, ↗ 9 cm, ↓ 20,5 cm



3,8W
240
Lumen



3W
189
Lumen

1 Orbit / Serie 946
4946.03.01.0000
EAN4003474282985
Chrom / Chrome

Energieeffizienzklasse /
energy efficiency class:
A+

Markenleuchtmittel inkl.
branded lamp incl.

↑ 53,5 cm, ↔ 45,5 cm,
↳ 8 cm

3 x LED / 3 W incl.
3000 K / 3 x 189 lm



3W
189
Lumen

2 Orbit / Serie 946
4946.04.01.0000
EAN4003474283067
Chrom / Chrome

Energieeffizienzklasse /
energy efficiency class:
A+

Markenleuchtmittel inkl.
branded lamp incl.

4 x LED / 3 W incl.
3000 K / 4 x 189 lm

↑ 40,5 cm,
↔ 40,5 cm, ↳ 12 cm



10W
620
Lumen

4 Orbit / Serie 946
3946.01.01.0000
EAN4003474283043
Chrom / Chrome

Energieeffizienzklasse /
energy efficiency class:
A

Markenleuchtmittel inkl.
branded lamp incl.

↑ 135 cm, ↳ 65 cm

1 x LED / 10 W incl.
3000 K / 1 x 620 lm

5 Orbit / Serie 946
8946.01.01.0000
EAN4003474283050
Chrom / Chrome

Energieeffizienzklasse /
energy efficiency class:
A

Markenleuchtmittel inkl.
branded lamp incl.

↑ 67 cm, ↳ 50 cm

1 x LED / 8 W incl.
3000 K / 1 x 511 lm

8W
511
Lumen

Faszination Licht

...fascination of light

Die filigranen Leuchten werden zu Lichtblicken des extravaganten Stils

These delicate lights show extravagant style

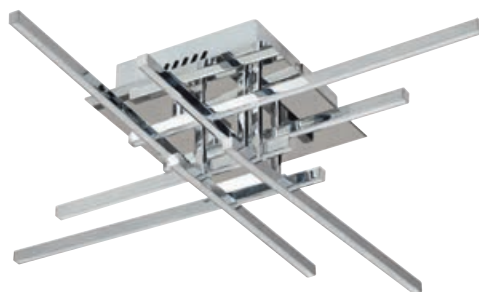

3,5W
224
Lumen

3 Orbit / Serie 946
9946.08.01.0000
EAN4003474283074
Chrom / Chrome

Energieeffizienzklasse /
energy efficiency class:
A

Markenleuchtmittel inkl.
branded lamp incl.

Dimmbar mittels geeignetem
Wanddimmer / dimmable by
suitable wall dimmer

↑ 56 cm, ↔ 56 cm, ↳ 13 cm

8 x LED / 3,5 W incl.
3000 K / 8 x 224 lm

LED Light
by WOFI

Neu!
New!



1 Troy / Serie 777
3777.09.01.0000
EAN4003474303338
Chrom / Chrome

 25 W LED incl.
3000 K / 1600 lm

Energieeffizienzklasse /
energy efficiency class:

A

Markenleuchtmittel inkl.
branded lamp incl.

↑ 167 cm, ↔ 56 cm



25W

1600
Lumen

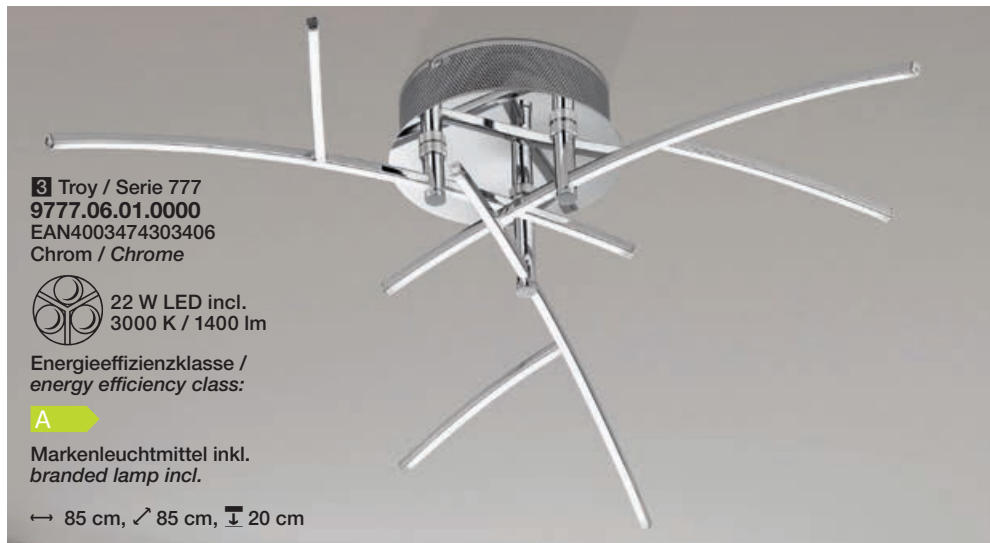

3 Troy / Serie 777
9777.06.01.0000
EAN4003474303406
Chrom / Chrome

 22 W LED incl.
3000 K / 1400 lm

Energieeffizienzklasse /
energy efficiency class:

A

Markenleuchtmittel inkl.
branded lamp incl.

↔ 85 cm, ↗ 85 cm, ↓ 20 cm

22W

1400
Lumen

LED Light
by **WOFI**

Minimalismus trifft Eleganz ...Minimalism meets elegance



2 Troy / Serie 777
9777.09.01.0000
EAN4003474303482
Chrom / Chrome

 24 W LED incl.
3000 K / 1500 lm

Energieeffizienzklasse /
energy efficiency class:

A

Markenleuchtmittel inkl.
branded lamp incl.

↔ 95 cm, ↗ 95 cm, ↓ 23 cm

24W

1500
Lumen

13W

800
Lumen

4 Troy / Serie 777
8777.06.01.0000
EAN4003474303345
Chrom / Chrome

 13 W LED incl.
3000 K / 800 lm

Energieeffizienzklasse /
energy efficiency class:

A

Markenleuchtmittel inkl.
branded lamp incl.

↑ 46 cm, ↔ 26 cm





24W
1900
Lumen

1 Benett / Serie 557
3557.05.01.0000
EAN4003474279480
Chrom / Chrome



 24 W LED incl.
3000 K / 1900 lm

Energieeffizienzklasse /
energy efficiency class:

A

Markenleuchtmittel inkl.
branded lamp incl.

↑ 190 cm, ⇄ 62 cm, ↗ 52 cm

  3-Stufen dimmbar
3-step dimmable



LED Light
by WOFI

39W
2800
Lumen

4 Benett / Serie 557
9557.10.01.0000
EAN4003474283197
Chrom / Chrome

 39 W LED incl.
3000 K / 2800 lm

Energieeffizienzklasse /
energy efficiency class:

A

Markenleuchtmittel inkl.
branded lamp incl.

↔ 150 cm, ↓ 24 cm

Licht für Individualisten ...Lights for individualists



9,5W
700
Lumen

2 Benett / Serie 557
3557.01.01.1100
EAN4003474281902
Chrom / Chrome

 1 x LED / 9,5 W incl.
3000 K / 1 x 700 lm

Energieeffizienzklasse /
energy efficiency class:

A

Markenleuchtmittel inkl.
branded lamp incl.

Ø 9 cm, ↓ 110 cm



7W
530
Lumen

3 Benett / Serie 557
3557.01.01.0850
EAN4003474281896
Chrom / Chrome

 1 x LED / 7 W incl.
3000 K / 1 x 530 lm

Energieeffizienzklasse /
energy efficiency class:

A+

Markenleuchtmittel inkl.
branded lamp incl.

Ø 9 cm, ↓ 85 cm



3,7W
280
Lumen

5 Benett / Serie 557
3557.01.01.0450
EAN4003474281889
Chrom / Chrome

 1 x LED / 3,7 W incl.
3000 K / 1 x 280 lm

Energieeffizienzklasse /
energy efficiency class:

A+

Markenleuchtmittel inkl.
branded lamp incl.

Ø 9 cm, ↓ 45 cm





32W
2200
Lumen

6 Benett / Serie 557
9557.16.01.0000
EAN4003474283203
Chrom / Chrome



32 W LED incl.
3000 K / 2200 lm

Energieeffizienzklasse /
energy efficiency class:

A

Markenleuchtmittel inkl.
branded lamp incl.

Ø 100 cm, ↓ 10 cm



7 Benett / Serie 557
9557.08.01.0000
EAN4003474291192
Chrom / Chrome



20 W LED incl.
3000 K / 1400 lm

Energieeffizienzklasse /
energy efficiency class:

A

Markenleuchtmittel inkl.
branded lamp incl.

Ø 60 cm, ↓ 7 cm

20W
1400
Lumen



LED Light
by WOLFF

*Designs, die das Leben
schöner machen*

...designs that make life more beautiful

8 Vela / Serie 543
9543.01.01.0000
EAN4003474279473
Chrom / Chrome



1 x LED / 22 W incl.
3000 K / 1 x 1600 lm

Energieeffizienzklasse /
energy efficiency class:

A

Markenleuchtmittel inkl.
branded lamp incl.

Ø 50 cm, ↓ 30 cm

22W
1600
Lumen

LED Light
by **WOFI**



Deckenleuchten mit Ausstrahlung

...ceiling lights with a radiant personality



1 Crux / Serie 416
9416.08.01.0000
EAN4003474286099
Chrom / Chrome

 26 W LED incl.
3000 K / 1900 lm

Energieeffizienzklasse /
energy efficiency class:

A

Markenleuchtmittel inkl.
branded lamp incl.

Ø 90 cm, \downarrow 17 cm

26W

1900
Lumen

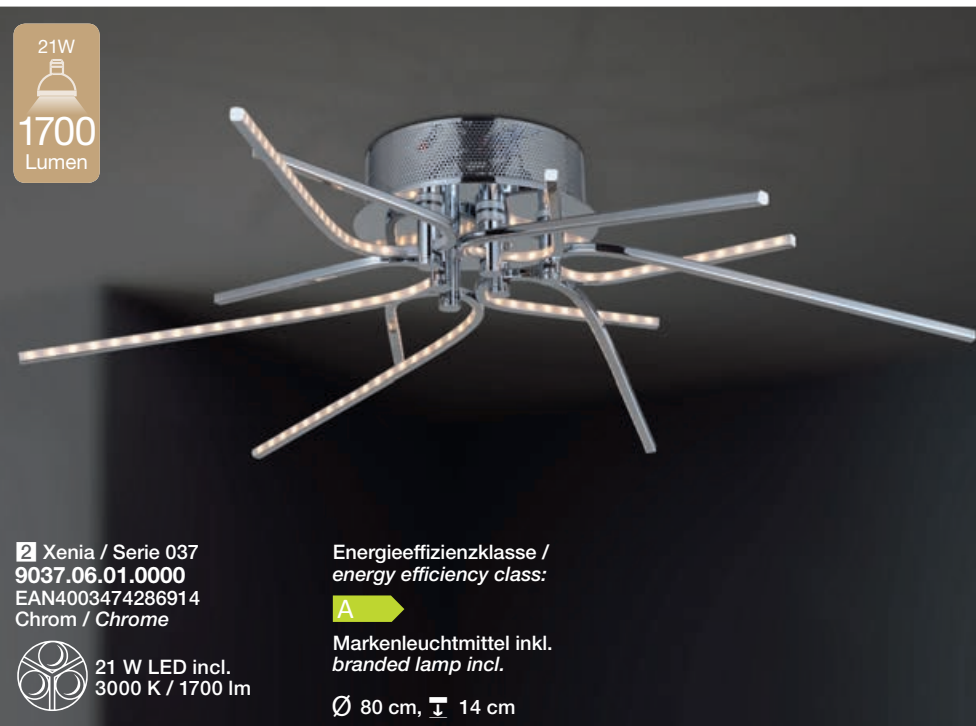

21W

1700
Lumen

2 Xenia / Serie 037
9037.06.01.0000
EAN4003474286914
Chrom / Chrome

 21 W LED incl.
3000 K / 1700 lm

Energieeffizienzklasse /
energy efficiency class:

A

Markenleuchtmittel inkl.
branded lamp incl.

Ø 80 cm, \downarrow 14 cm

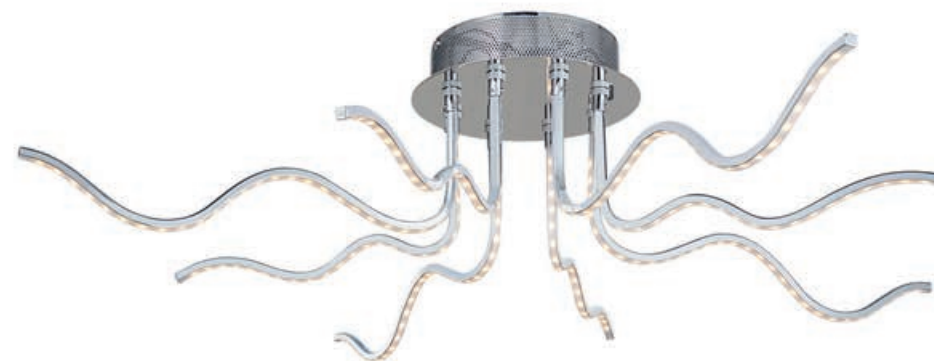

3 Aurora / Serie 759
9759.08.01.0000
EAN4003474286907
Chrom / Chrome

 20 W LED incl.
3000 K / 1500 lm

Energieeffizienzklasse /
energy efficiency class:

A

Markenleuchtmittel inkl.
branded lamp incl.

Ø 90 cm, \downarrow 23 cm

20W

1500
Lumen

1 Lex / Serie 024
6024.01.01.0000
 EAN4003474286112
 Chrom / Chrome

 1 x LED / 27 W incl.
 3000 K / 1 x 1890 lm

Energieeffizienzklasse /
 energy efficiency class:

A

Markenleuchtmittel inkl.
 branded lamp incl.

↔ 80 cm, ↓ 150 cm

 27W
1890
 Lumen



2 Lex / Serie 024
9024.01.01.0000
 EAN4003474286136
 Chrom / Chrome

 1 x LED / 27 W incl.
 3000 K / 1 x 1890 lm

Energieeffizienzklasse /
 energy efficiency class:

A

Markenleuchtmittel inkl.
 branded lamp incl.

↔ 80 cm, ↓ 36 cm

 27W
1890
 Lumen

 11W
800
 Lumen

3 Lex / Serie 024
8024.01.01.0000
 EAN4003474286129
 Chrom / Chrome

 1 x LED / 11 W incl.
 3000 K / 1 x 800 lm

Energieeffizienzklasse /
 energy efficiency class:

A

Markenleuchtmittel inkl.
 branded lamp incl.

↔ 70 cm, ↓ 35 cm

 3-Stufen dimmbar
 3-step dimmable

Ära der Eleganz
 ...time for elegance



LED Light
 by **WOFI**

LED Light
by **WOFI**



1 Laval / Serie 369
9369.01.01.0000
EAN4003474286839
Chrom / Chrome

 1 x LED / 19 W incl.
3000 K / 1 x 1400 lm

Energieeffizienzklasse /
energy efficiency class:

A

Markenleuchtmittel inkl.
branded lamp incl.

Ø 25 cm, ↑ 38 cm

19W

1400
Lumen

2 Laval / Serie 369
9369.01.64.1000
EAN4003474304557
Nickel-matt /
Nickel matt finished

 1 x LED / 19 W incl.
3000 K / 1 x 1400 lm

Energieeffizienzklasse /
energy efficiency class:

A

Markenleuchtmittel inkl.
branded lamp incl.

Ø 42 cm, ↑ 30 cm

19W

1400
Lumen



Innovationen für Morgen
...innovations for tomorrow

10W

700
Lumen

Neu!
Neu!

3 Orland / Serie 510
8510.01.01.0000
EAN4003474301891
Chrom / Chrome

 1 x LED / 10 W incl.
3000 K / 1 x 700 lm

Energieeffizienzklasse /
energy efficiency class:

A

Markenleuchtmittel inkl.
branded lamp incl.

↔ 37 cm, ↑ 40 cm



Guter Stil macht seine Runde

...Good style makes its way round



6W
500
Lumen

Neu!
Neu!

1 Fulton / Serie 740
8740.01.01.0000
EAN4003474302669
Chrom / Chrome

 1 x LED / 6 W incl.
3000 K / 1 x 500 lm

Energieeffizienzklasse /
energy efficiency class:

A+

Markenleuchtmittel inkl.
branded lamp incl.

Ø 12 cm, ↑ 13 cm

Glas / Glass: 8019, Ø 11,7 cm, ↑ 5,3 cm
8020, Ø 11,7 cm, ↑ 4,7 cm

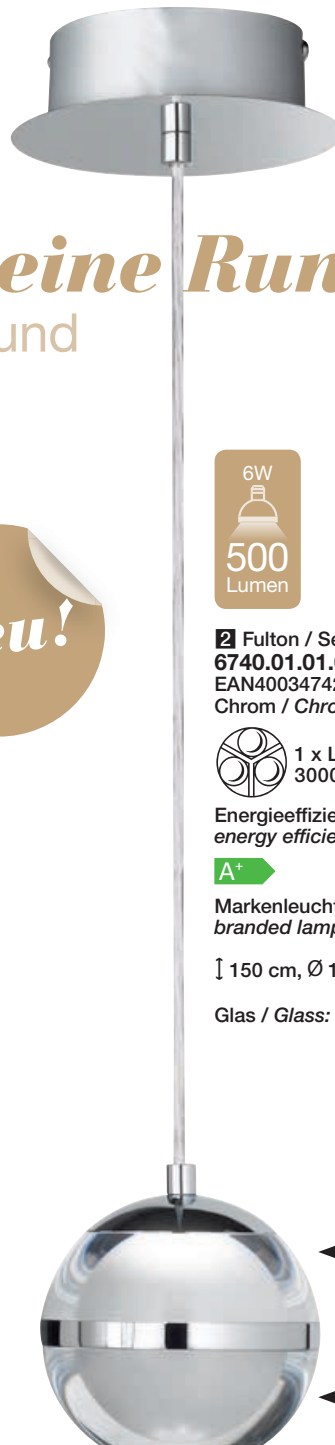

6W
500
Lumen

2 Fulton / Serie 740
6740.01.01.0000
EAN4003474259673
Chrom / Chrome

 1 x LED / 6 W incl.
3000 K / 1 x 500 lm

Energieeffizienzklasse /
energy efficiency class:

A+

Markenleuchtmittel inkl.
branded lamp incl.

↑ 150 cm, Ø 12 cm

Glas / Glass: 8019, Ø 11,7 cm, ↑ 5,3 cm
8020, Ø 11,7 cm, ↑ 4,7 cm

← 8019

← 8020



6W
500
Lumen

3 Fulton / Serie 740
7740.04.01.0000
EAN4003474302737
Chrom / Chrome

 4 x LED / 6 W incl.
3000 K / 4 x 500 lm

Energieeffizienzklasse /
energy efficiency class:

A+

Markenleuchtmittel inkl.
branded lamp incl.

↑ 150 cm, ↔ 75 cm, ↗ 8,5 cm

Glas / Glass: 8019, Ø 11,7 cm, ↑ 5,3 cm
8020, Ø 11,7 cm, ↑ 4,7 cm

Weitere Leuchten zu dieser Serie
finden Sie auf Seite 114

You'll find matching products on page 114



5W
430
Lumen

1 Midu / Serie 193
8193.01.01.0000
EAN4003474284248
Chrom / Chrome



1 x LED / 5 W incl.
3000 K / 1 x 430 lm

Energieeffizienzklasse /
energy efficiency class:

A⁺

Markenleuchtmittel inkl.
branded lamp incl.

Ø 10 cm, ↓ 25 cm

Glas / Glass: 6625,
Ø 3,5 cm, ↓ 12,6 cm



2 Midu / Serie 193
4193.01.01.0000
EAN4003474280714
Chrom / Chrome



1 x LED / 5 W incl.
3000 K / 1 x 430 lm

Energieeffizienzklasse /
energy efficiency class:

A⁺

Markenleuchtmittel inkl.
branded lamp incl.

↓ 23 cm, ↔ 8,5 cm, ↗ 14 cm

Glas / Glass: 6609,
Ø 3,5 cm, ↓ 8 cm

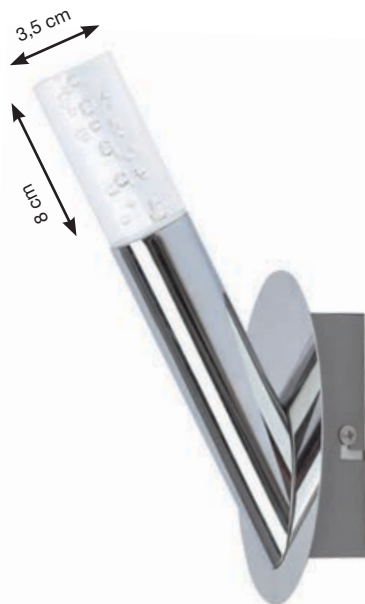

5W
430
Lumen

3 Midu / Serie 193
3193.05.01.0000
EAN4003474284231
Chrom / Chrome



5 x LED / 5 W incl.
3000 K / 5 x 430 lm

Energieeffizienzklasse /
energy efficiency class:

A⁺

Markenleuchtmittel inkl.
branded lamp incl.

Ø 50 cm, ↓ 160 cm,

Glas / Glass: 6626,
Ø 4,1 cm, ↓ 11,2 cm



4 Midu / Serie 193
9193.06.01.0000
EAN4003474281124
Chrom / Chrome



6 x LED / 5 W incl.
3000 K / 6 x 430 lm

Energieeffizienzklasse /
energy efficiency class:

A⁺

Markenleuchtmittel inkl.
branded lamp incl.

Ø 45,6 cm, ↓ 14,5 cm

Glas / Glass: 6609,
Ø 3,5 cm, ↓ 8 cm



5 Midu / Serie 193
9193.03.01.0000
EAN4003474280738
Chrom / Chrome



3 x LED / 5 W incl.
3000 K / 3 x 430 lm

Energieeffizienzklasse /
energy efficiency class:

A⁺

Markenleuchtmittel inkl.
branded lamp incl.

Ø 43,5 cm, ↓ 14,5 cm

Glas / Glass: 6609,
Ø 3,5 cm, ↓ 8 cm

Neu!
Neu!



1 Maar / Serie 806
7806.05.01.0000
EAN4003474274072
Chrom / Chrome

5 x LED / 5 W incl.
3000 K / 5 x 400 lm

Energieeffizienzklasse /
energy efficiency class:

A+

Markenleuchtmittel inkl.
branded lamp incl.

∟ 150 cm, ↔ 96 cm

Glas / Glass: 3054, Ø 5 cm

Dimmbar mittels geeignetem
Wanddimmer / dimmable by
suitable wall dimmer



5W

400
Lumen



2 Cleo / Serie 099
6099.24.01.0000
EAN4003474302461
Chrom / Chrome

36 W LED incl.
3000 K / 2880 lm

Energieeffizienzklasse /
energy efficiency class:

A

Markenleuchtmittel inkl.
branded lamp incl.

Ø 45 cm, ∟ 150 cm

Glas / Glass: 1162,
∟ 4,3 cm, Ø 2,2 cm

36W

2880
Lumen



5W

380
Lumen

3 Kent / Serie 060
9060.06.01.0000
EAN4003474283272
Chrom / Chrome

6 x LED / 5 W incl.
3000 K / 6 x 380 lm

Energieeffizienzklasse /
energy efficiency class:

A+

Markenleuchtmittel inkl.
branded lamp incl.

Ø 25 cm, ∟ 16 cm

Glas / Glass: 1406,
Ø 4 cm, ∟ 9 cm



1 Filiz / Serie 926
3926.01.08.2000
 EAN4003474305479
 Eiche hell / Light oak
 geeignet für / suitable for
 Energieeffizienzklasse /
 energy efficiency class:

Ø 50 cm, ↑ 147 cm



Schirm / Shade: 6120
 Ø 50 cm, ↑ 22 cm

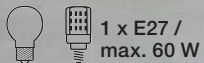

Fit for LED



*Mit Schirm, Charme
 und Leuchtkraft*
 ...Shade, charm and brightness

Neu!
Neu!



2 Filiz / Serie 926
6926.01.08.2000
 EAN4003474306230
 Eiche hell / Light oak
 geeignet für / suitable for
 Energieeffizienzklasse /
 energy efficiency class:

Ø 50 cm, ↑ 150 cm



Schirm / Shade: 6303
 Ø 50 cm, ↑ 22 cm



Fit for LED



3 Filiz / Serie 926
8926.01.08.2000
 EAN4003474305493
 Eiche hell / Light oak
 geeignet für / suitable for
 Energieeffizienzklasse /
 energy efficiency class:

Ø 28 cm, ↑ 57,5 cm



Schirm / Shade: 6302
 Ø 28 cm, ↑ 22 cm



Fit for LED



LED Light
by **WOFI**



2 Toulouse / Serie 997
6997.01.32.0000
EAN4003474292595
Messing-matt /
Brass matt finished



1 x LED / 21,6 W incl.
2700 K / 1 x 2000 lm

Energieeffizienzklasse /
energy efficiency class:
A+

Markenleuchtmittel inkl.
branded lamp incl.

Ø 18 cm, ↑ 150 cm

Dimmbar mittels geeignetem
Wanddimmer /
dimmmable by suitable wall
dimmer



Leuchtschirm exkl. /
lampshade excl.

1 Toulouse / Serie 997
6997.01.64.0000
EAN4003474291574
Nickel-matt /
Nickel matt finished



1 x LED / 21,6 W incl.
3000 K / 1 x 2000 lm

Energieeffizienzklasse /
energy efficiency class:

A+

Markenleuchtmittel inkl.
branded lamp incl.

Ø 18 cm, ↑ 150 cm

Dimmbar mittels geeignetem
Wanddimmer /
dimmmable by suitable wall
dimmer



Leuchtschirm exkl. /
lampshade excl.



3 Toulouse / Serie 997
4116
EAN4003474291758
Grau / Grey
Ø 45 cm, ↑ 22 cm



4 Toulouse / Serie 997
4152
EAN4003474297675
Cappuccino / Cappuccino
Ø 45 cm, ↑ 22 cm



5 Toulouse / Serie 997
4127
EAN4003474291857
Champagner farbig /
Champagne colour
Ø 45 cm, ↑ 22 cm



6 Toulouse / Serie 997
4114
EAN4003474291734
Weiß / White
Ø 45 cm, ↑ 22 cm



7 Toulouse / Serie 997
3997.01.64.0000
EAN4003474291550
Nickel-matt /
Nickel matt finished



1 x LED / 21,6 W incl.
3000 K / 1 x 2000 lm

Energieeffizienzklasse /
energy efficiency class:

A+

Markenleuchtmittel inkl.
branded lamp incl.

Ø 25 cm, ↑ 140 cm



Leuchtschirm exkl. /
lampshade excl.

21,6W
2000
Lumen



8 Toulouse / Serie 997
4111
EAN4003474164281
Weiß / White
Ø 45 cm, ↑ 22 cm



9 Toulouse / Serie 997
4154
EAN40034742976699
Cappuccino / Cappuccino
Ø 45 cm, ↑ 22 cm



10 Toulouse / Serie 997
4113
EAN4003474291727
Grau / Grey
Ø 45 cm, ↑ 22 cm

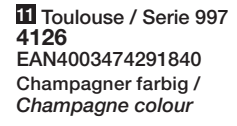

11 Toulouse / Serie 997
4126
EAN4003474291840
Champagner farbig /
Champagne colour
Ø 45 cm, ↑ 22 cm



12 Toulouse / Serie 997
3997.01.32.0000
EAN4003474292588
Messing-matt /
Brass matt finished



1 x LED / 21,6 W incl.
2700 K / 1 x 2000 lm

Energieeffizienzklasse /
energy efficiency class:

A+

Markenleuchtmittel inkl.
branded lamp incl.

Ø 25 cm, ↑ 140 cm



Leuchtschirm exkl. /
lampshade excl.



21,6W
2000
Lumen



3 Toulouse / Serie 997
4119
EAN4003474291789
Grau / Grey

↔ 100 cm, ↓ 14 cm,
↗ 25 cm



4 Toulouse / Serie 997
4153
EAN4003474297682
Cappuccino /
Cappuccino

↔ 100 cm, ↓ 14 cm,
↗ 25 cm



5 Toulouse / Serie 997
4128
EAN4003474291864
Champagner farbig /
Champagne colour

↔ 100 cm, ↓ 14 cm,
↗ 25 cm



6 Toulouse / Serie 997
4117
EAN4003474291765
Weiß / White

↔ 100 cm, ↓ 14 cm,
↗ 25 cm



1 Toulouse / Serie 997
7997.01.64.0000
EAN4003474292236
Nickel-matt / Nickel matt finished



1 x LED / 21,6 W incl.
3000 K / 1 x 2000 lm

Energieeffizienzklasse /
energy efficiency class:



Markenleuchtmittel inkl.

branded lamp incl.

↓ 150 cm, ↔ 76 cm

Dimmbar mittels geeignetem
Wanddimmer /
dimnable by suitable wall dimmer



Leuchtschirm exkl. /
lampshade excl.

2 Toulouse / Serie 997
7997.01.32.0000
EAN4003474292601
Messing-matt /
Brass matt finished



1 x LED / 21,6 W incl.
2700 K / 1 x 2000 lm

Energieeffizienzklasse /
energy efficiency class:



Markenleuchtmittel inkl.
branded lamp incl.

↓ 150 cm, ↔ 76 cm

Dimmbar mittels geeignetem
Wanddimmer /
dimnable by suitable wall dimmer



Leuchtschirm exkl. /
lampshade excl.

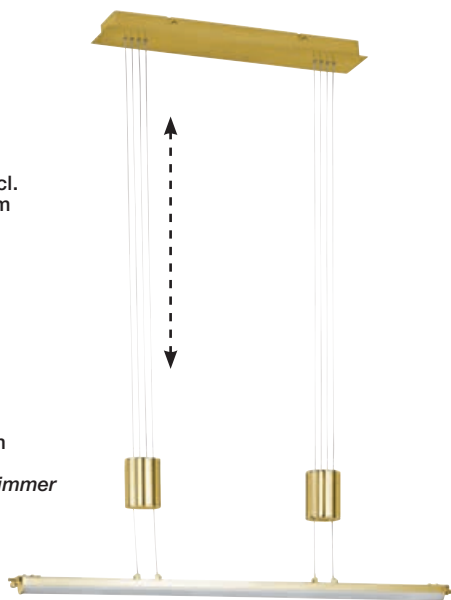

7 Toulouse / Serie 997
8997.01.64.0000
EAN4003474291635
Nickel-matt / Nickel matt finished



1 x LED / 13,4 W incl.
3000 K / 1 x 1200 lm

Energieeffizienzklasse /
energy efficiency class:



Markenleuchtmittel inkl.
branded lamp incl.

∅ 18 cm, ↓ 45 cm



Leuchtschirm exkl. /
lampshade excl.

13,4W
1200
Lumen



LED Light
by WOFI



8 Toulouse / Serie 997
8997.01.32.0000
EAN4003474292618
Messing-matt /
Brass matt finished



1 x LED / 13,4 W incl.
2700 K / 1 x 1200 lm

Energieeffizienzklasse /
energy efficiency class:



Markenleuchtmittel inkl.
branded lamp incl.

∅ 18 cm, ↓ 45 cm



Leuchtschirm exkl. /
lampshade excl.

9 Toulouse / Serie 997
4120
EAN4003474291796
Weiß / White

∅ 25 cm, ↓ 18,5 cm

10 Toulouse / Serie 997
4129
EAN4003474291871
Champagner farbig /
Champagne colour

∅ 25 cm, ↓ 18,5 cm

11 Toulouse / Serie 997
4151
EAN4003474297668
Cappuccino /
Cappuccino

∅ 25 cm, ↓ 18,5 cm

12 Toulouse / Serie 997
4122
EAN4003474291819
Grau / Grey

∅ 25 cm, ↓ 18,5 cm

1 Toulouse / Serie 997
9997.01.32.0000
 EAN4003474292625
 Messing-matt /
Brass matt finished

Toulouse / Serie 997
9997.01.64.0000
 EAN4003474291673
 Nickel-matt /
Nickel matt finished



1 x LED / 21,6 W incl.
 1 x 2000 lm

Energieeffizienzklasse /
energy efficiency class:



Markenleuchtmittel inkl.
branded lamp incl.

Ø 16 cm, ↓ 9 cm

Dimmbar mittels geeignetem
 Wanddimmer / *dimmable by*
suitable wall dimmer



Leuchtschirm exkl. /
lampshade excl.



2700 K



3000 K



21,6W
 2000
 Lumen



6



7



8



9

6 Toulouse / Serie 997
4125
 EAN4003474097053
 Grau / Grey
 Ø 45 cm, ↓ 15 cm

7 Toulouse / Serie 997
4123
 EAN4003474291826
 Weiß / White
 Ø 45 cm, ↓ 15 cm

8 Toulouse / Serie 997
4156
 EAN4003474297712
 Cappuccino / Cappuccino
 Ø 45 cm, ↓ 15 cm

9 Toulouse / Serie 997
4130
 EAN4003474213712
 Champagner farbig /
Champagne colour
 Ø 45 cm, ↓ 15 cm

LED Light
 by WOFI



2



3



4



5

2 Toulouse / Serie 997
4131
 EAN4003474213729
 Champagner farbig /
Champagne colour
 Ø 80 cm, ↓ 15 cm

3 Toulouse / Serie 997
4132
 EAN4003474213743
 Weiß / White
 Ø 80 cm, ↓ 15 cm

4 Toulouse / Serie 997
4155
 EAN4003474297705
 Cappuccino /
Cappuccino
 Ø 80 cm, ↓ 15 cm

5 Toulouse / Serie 997
4134
 EAN4003474291888
 Grau / Grey
 Ø 80 cm, ↓ 15 cm

10 Toulouse / Serie 997
9997.01.06.0800
 EAN4003474306209
 Weiß / White



1 x LED / 35 W incl.
 3000 K / 1 x 3800 lm

Energieeffizienzklasse /
energy efficiency class:



Markenleuchtmittel inkl.
branded lamp incl.

Ø 80 cm, ↓ 15 cm

Dimmbar mittels geeignetem
 Wanddimmer / *dimmable by*
suitable wall dimmer



Leuchtschirm exkl. /
lampshade excl.



35W
 3800
 Lumen



80 cm



5W
450
Lumen

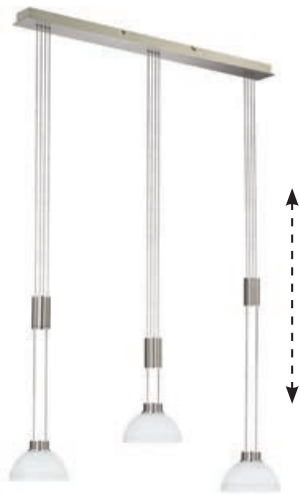

1 Class / Serie 450
7450.03.64.0000
EAN4003474270586
Nickel-matt / Nickel matt finished

3 x LED / 5 W incl.
3000 K / 3 x 450 lm

Energieeffizienzklasse /
energy efficiency class:

A+

Markenleuchtmittel inkl.
branded lamp incl.

↔ 86 cm, ↑ 150 cm

Glas: opal weiß satiniert /
Innenschliff
Glass: opal white satined /
cutline inside
Glas / Glass: 6264,
Ø 16 cm, ↑ 8 cm

Dimmbar mittels ge-
eignetem Wanddimmer /
dimmable by suitable
wall dimmer



2 Class / Serie 450
8450.01.64.0000
EAN4003474271613
Nickel-matt / Nickel matt finished

1 x LED / 6 W incl.
3000 K / 1 x 500 lm

Energieeffizienzklasse /
energy efficiency class:

A+

Markenleuchtmittel inkl.
branded lamp incl.

Ø 16 cm, ↑ 29 cm

Glas: opal weiß satiniert /
Innenschliff
Glass: opal white satined /
cutline inside
Glas / Glass: 6364,
Ø 16 cm, ↑ 8 cm

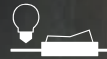

6W
500
Lumen

LED Light
by WOFI®



16,8W
1200
Lumen

3 Class / Serie 450
3450.01.64.0000
EAN4003474271606
Nickel-matt / Nickel matt finished

1 x LED / 16,8 W incl.
3000 K / 1 x 1200 lm

Energieeffizienzklasse /
energy efficiency class:

A

Markenleuchtmittel inkl.
branded lamp incl.

Ø 35 cm, ↑ 141 cm
Glas: opal weiß satiniert /
Innenschliff
Glass: opal white satined /
cutline inside
Glas / Glass: 6262,
Ø 35 cm, ↑ 15 cm



9,6W
900
Lumen

4 Class / Serie 450
8450.01.64.0250
EAN4003474272658
Nickel-matt / Nickel matt finished

1 x LED / 9,6 W incl.
3000 K / 1 x 900 lm

Energieeffizienzklasse /
energy efficiency class:

A+

Markenleuchtmittel inkl.
branded lamp incl.

Ø 25 cm, ↑ 45 cm
Glas: opal weiß satiniert /
Innenschliff
Glass: opal white satined /
cutline inside
Glas / Glass: 6263,
Ø 25 cm, ↑ 12 cm



5 Class / Serie 450
7450.02.64.0000
EAN4003474270593
Nickel-matt / Nickel matt finished

2 x LED / 5 W incl.
3000 K / 2 x 450 lm

Energieeffizienzklasse /
energy efficiency class:

A+

Markenleuchtmittel inkl.
branded lamp incl.

↔ 48,5 cm, ↑ 150 cm
Glas: opal weiß satiniert /
Innenschliff
Glass: opal white satined /
cutline inside
Glas / Glass: 6264,
Ø 16 cm, ↑ 8 cm
Dimmbar mittels ge-
eignetem Wanddimmer /
dimmable by suitable wall dimmer



5W
450
Lumen

6 Class / Serie 450
6450.01.64.0250
EAN4003474273686
Nickel-matt / Nickel matt finished

1 x LED / 10 W incl.
3000 K / 1 x 900 lm

Energieeffizienzklasse /
energy efficiency class:

A+

Markenleuchtmittel inkl.
branded lamp incl.

Ø 25 cm, ↑ 150 cm
Glas: opal weiß satiniert /
Innenschliff
Glass: opal white satined /
cutline inside
Glas / Glass: 6550,
Ø 25 cm, ↑ 11,9 cm
Dimmbar mittels geeignetem
Wanddimmer /
dimmable by suitable wall dimmer



10W
900
Lumen

LED Light
by **WOFI**



1 Troja / Serie 973
9973.09.64.0000
EAN4003474283678
Nickel-matt / Nickel matt finished

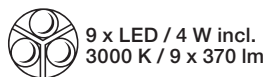

Energieeffizienzklasse /
energy efficiency class:

A⁺

Markenleuchtmittel inkl.
branded lamp incl.

Ø 60 cm, \perp 27 cm
Glas / Glass: 1417, Ø 12 cm



2 Troja / Serie 973
9973.05.64.0000
EAN4003474283661
Nickel-matt / Nickel matt finished

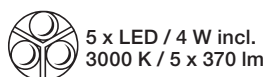

Energieeffizienzklasse /
energy efficiency class:

A⁺

Markenleuchtmittel inkl.
branded lamp incl.

Ø 51 cm, \perp 20,5 cm
Glas / Glass: 1417, Ø 12 cm



3 Troja / Serie 973
9973.05.32.0000
EAN4003474291123
Messing-matt /
Brass matt finished



5 x LED / 4 W incl.
2700 K / 5 x 370 lm

Energieeffizienzklasse /
energy efficiency class:

A⁺

Markenleuchtmittel inkl.
branded lamp incl.

Ø 51 cm, \perp 20,5 cm
Glas / Glass: 1417, Ø 12 cm

Klassische Harmonie ...classic harmony

Gemacht für
Generationen

Klassische Eleganz verbunden
mit moderner Technologie –
die Leuchten der Serie TROJA.

Made for
generations

Classic elegance combined
with modern technology –
the light of the TROJA series.



1 Deventer / Serie 449
8449.01.01.0000
 EAN4003474259277
 Chrom / Chrome
 geeignet für / suitable for /
 Energieeffizienzklasse /
 energy efficiency class:



  1 x E27 /
 max.42 W

Fit for LED

Ø 14 cm, ↑ 70 cm,
 ↳ 50 cm,



3 Deventer / Serie 449
3449.01.01.0000
 EAN4003474259703
 Chrom / Chrome
 geeignet für / suitable for /
 Energieeffizienzklasse /
 energy efficiency class:



  1 x E27 /
 max.60 W

Fit for LED

Ø 32 cm, ↑ 170 cm, ↳ 90 cm,



4 Deventer / Serie 449
6449.01.01.0350
 EAN4003474261928
 Chrom / Chrome
 geeignet für / suitable for /
 Energieeffizienzklasse /
 energy efficiency class:



  1 x E27 /
 max.60 W

Fit for LED

Ø 34 cm, ↑ 150 cm,

Ø 34 cm

Faszination Licht
 ...fascination of light



1 Lacchino / Serie 128
3128.02.09.0000
 EAN4003474169484
 Antik braun / *Antique brown*
 geeignet für / *suitable for* /
 Energieeffizienzklasse /
energy efficiency class:



 1 x E27 / max. 150 W

 1 x E14 / max. 40 W

↑ 180 cm, ⇨ 25 cm

Glas / Glass: 6284, ⇨ 30 cm,
 7082, ⇨ 15 cm



2 Lacchino / Serie 128
7128.02.09.0000
 EAN4003474168432
 Antik braun / *Antique brown*
 geeignet für / *suitable for* /
 Energieeffizienzklasse /
energy efficiency class:



  2 x E27 /
 max. 60 W

Fit for LED

↑ 150 cm, ⇨ 78 cm

Glas / Glass: 7083,
 ⇨ 24,5 cm, ↑ 10,7 cm

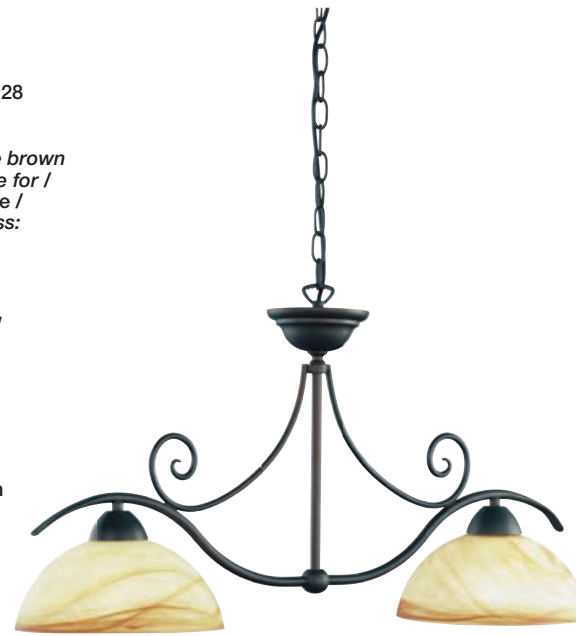

Für Nostalgie-Fans ... For fans of nostalgie

3 Lacchino / Serie 128
6128.01.09.0000
 EAN4003474168661
 Antik braun / *Antique brown*
 geeignet für / *suitable for* /
 Energieeffizienzklasse /
energy efficiency class:



  1 x E27 /
 max. 60 W

Fit for LED

Ø 30 cm, ↑ 150 cm

Glas / Glass: 6284,
 ⇨ 30 cm, ↑ 14,3 cm



4 Lacchino / Serie 128
5128.03.09.0000
 EAN4003474168654
 Antik braun /
Antique brown
 geeignet für / *suitable for* /
 Energieeffizienzklasse /
energy efficiency class:



  3 x E27 /
 max. 60 W

Fit for LED

Ø 80 cm, ↑ 150 cm,
 Glas / Glass: 7083
 ⇨ 24,5 cm, ↑ 10,7 cm



5 Lacchino / Serie 128
4128.01.09.0000
 EAN4003474168647
 Antik braun / *Antique brown*
 geeignet für / *suitable for* /
 Energieeffizienzklasse /
energy efficiency class:



  1 x E27 /
 max. 60 W

Fit for LED

⇨ 52 cm, ⇨ 15 cm, ↑ 21 cm

Glas / Glass: 7085, ⇨ 30 cm

1 Verre / Serie 240
6240.01.01.0000
 EAN4003474271040
 Chrom / Chrome

1 x E27 / max. 60 W

Fit for LED
 Ø 30 cm, ↓ 150 cm

Glas: klar mit Drahtgeflecht innen / Glass: clear with wire inside
 Glas / Glass: 6276

geeignet für / suitable for / Energieeffizienzklasse / energy efficiency class:
A++

2 Verre / Serie 240
8240.01.01.0010
 EAN4003474272948
 Chrom / Chrome

1 x G9 / 33 W incl. 2700 K / 1 x 460 lm

Energieeffizienzklasse / energy efficiency class:
D

Markenleuchtmittel inkl. branded lamp incl.

HALOGEN EGD

Ø 13 cm, ↓ 17 cm

Glas / Glass: 6091, Ø 2,5 cm 6277, Ø 13 cm

Glas: klar mit Drahtgeflecht innen / Glass: clear with wire inside

33W
 460 Lumen

3 Verre / Serie 240
3240.05.01.0000
 EAN4003474272931
 Chrom / Chrome

5 x G9 / 33 W incl. 2700 K / 5 x 460 lm

Energieeffizienzklasse / energy efficiency class:
D

Markenleuchtmittel inkl. branded lamp incl.

HALOGEN EGD

Ø 28 cm, ↓ 170 cm

Glas: klar mit Drahtgeflecht innen / Glass: clear with wire inside
 Glas / Glass: 6091, Ø 2,5 cm 6274, Ø 10 cm

33W
 460 Lumen

4 Verre / Serie 240
9240.07.01.0000
 EAN4003474271101
 Chrom / Chrome

7 x G4 / 12 V / 20 W incl. 2900 K / 7 x 300 lm

Energieeffizienzklasse / energy efficiency class:
C

Markenleuchtmittel inkl. branded lamp incl.

↓ 13 cm, ↔ 150 cm, ↗ 55 cm

Glas: klar mit Drahtgeflecht innen / Glass: clear with wire inside
 Glas / Glass: 6275, Ø 8 cm

5 Verre / Serie 240
9240.04.01.0000
 EAN4003474271132
 Chrom / Chrome

4 x G4 / 12 V / 20 W incl. 2900 K / 4 x 300 lm

Energieeffizienzklasse / energy efficiency class:
C

Markenleuchtmittel inkl. branded lamp incl.

Ø 54 cm, ↓ 23 cm

Glas: klar mit Drahtgeflecht innen / Glass: clear with wire inside
 Glas / Glass: 6275, Ø 8 cm

20W
 300 Lumen

6 Verre / Serie 240
9240.06.01.0000
 EAN4003474271118
 Chrom / Chrome

6 x G4 / 12 V / 20 W incl. 2900 K / 6 x 300 lm

Energieeffizienzklasse / energy efficiency class:
C

Markenleuchtmittel inkl. branded lamp incl.

Ø 61 cm, ↓ 22 cm

Glas: klar mit Drahtgeflecht innen / Glass: clear with wire inside
 Glas / Glass: 6275, Ø 8 cm

7 Verre / Serie 240
9240.08.01.0000
 EAN4003474271125
 Chrom / Chrome

8 x G4 / 12 V / 20 W incl. 2900 K / 8 x 300 lm

Energieeffizienzklasse / energy efficiency class:
C

Markenleuchtmittel inkl. branded lamp incl.

Ø 76 cm, ↓ 22 cm

Glas: klar mit Drahtgeflecht innen / Glass: clear with wire inside
 Glas / Glass: 6275, Ø 8 cm

Filigrane Leuchtoobjekte

...Delicate lighting objects



1 Arc / Serie 306
9306.12.01.0000
 EAN4003474191560
 Chrom / Chrome

 12 x G4 / 12 V / 20 W incl.
 2800 K / 12 x 320 lm

Energieeffizienzklasse /
 energy efficiency class:

C

Markenleuchtmittel inkl. /
 branded lamp incl.

Ø 80 cm, \updownarrow 22 cm

Glas / Glass: 6345, Ø 9 cm

20W

320
 Lumen



33W

460
 Lumen

2 Arc / Serie 306
8306.01.01.0000
 EAN4003474243108
 Chrom / Chrome

 1 x G9 / 33 W incl.
 2700 K / 1 x 460 lm

Energieeffizienzklasse /
 energy efficiency class:

D

Markenleuchtmittel inkl.

branded lamp
 incl.

**HALOGEN
 ECD**

Ø 13 cm, \updownarrow 18 cm

Glas / Glass:
 6450, Ø 13 cm



3 Arc / Serie 306
8306.03.01.0000
 EAN4003474243290
 Chrom / Chrome

 3 x G9 / 33 W incl.
 2700 K / 3 x 460 lm

Energieeffizienzklasse /
 energy efficiency class:

D

Markenleuchtmittel inkl.
 branded lamp incl.

**HALOGEN
 ECD**

Ø 26 cm, \updownarrow 51 cm

Glas / Glass:
 6452, Ø 11,5 cm



4 Arc / Serie 306
9306.03.01.0000
 EAN4003474243061
 Chrom / Chrome

 3 x G9 / 33 W incl.
 2700 K / 3 x 460 lm

Energieeffizienzklasse /
 energy efficiency class:

D

Markenleuchtmittel inkl.
 branded lamp incl.

**HALOGEN
 ECD**

Ø 50 cm, \updownarrow 27 cm

Glas / Glass:
 6452, Ø 11,5 cm

5 Arc / Serie 306
3306.05.01.0000
 EAN4003474243054
 Chrom / Chrome

 5 x G9 / 33 W incl.
 2700 K / 5 x 460 lm

Energieeffizienzklasse /
 energy efficiency class:

D

Markenleuchtmittel inkl.
 branded lamp incl.

**HALOGEN
 ECD**

Ø 30 cm, \updownarrow 180 cm

Glas / Glass:
 6452, Ø 11,5 cm





1 Astro / Serie 360
4360.06.01.0000
 EAN4003474231969
 Chrom / Chrome

10W
 120 Lumen

energy efficiency class:
C

Markenleuchtmittel inkl.
 branded lamp incl.

6 x G4 / 12 V / 10 W incl.
 2800 K / 6 x 120 lm

↔ 59 cm, ↗ 35 cm, ↓ 11 cm

Glas / Glass: 6345, Ø 9 cm

Energieeffizienzklasse /



2 Astro / Serie 360
9360.16.01.0000
 EAN4003474231440
 Chrom / Chrome

20W
 300 Lumen

energy efficiency class:
C

Markenleuchtmittel inkl.
 branded lamp incl.

16 x G4 / 12 V / 20 W incl.
 2900 K / 16 x 300 lm

Ø 106 cm, ↓ 36 cm

Glas / Glass: 6345, Ø 9 cm



Energieeffizienzklasse /

3 Astro / Serie 360
7360.04.01.0000
 EAN4003474240558
 Chrom / Chrome

20W
 300 Lumen

energy efficiency class:
C

Markenleuchtmittel inkl.
 branded lamp incl.

4 x G4 / 12 V / 20 W incl.
 2900 K / 4 x 300 lm

↓ 150 cm, ↔ 73,5 cm

Glas / Glass: 6345, Ø 9 cm

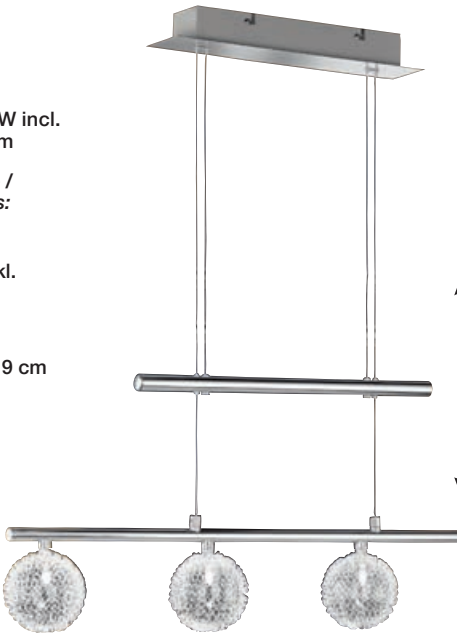

Energieeffizienzklasse /



4 Astro / Serie 360
9360.04.01.0000
 EAN4003474231884
 Chrom / Chrome

20W
 320 Lumen

energy efficiency class:
C

Markenleuchtmittel inkl.
 branded lamp incl.

4 x G4 / 12 V / 20 W incl.
 2900 K / 4 x 320 lm

Ø 52 cm, ↓ 20 cm

Glas / Glass: 6345, Ø 9 cm

Energieeffizienzklasse /

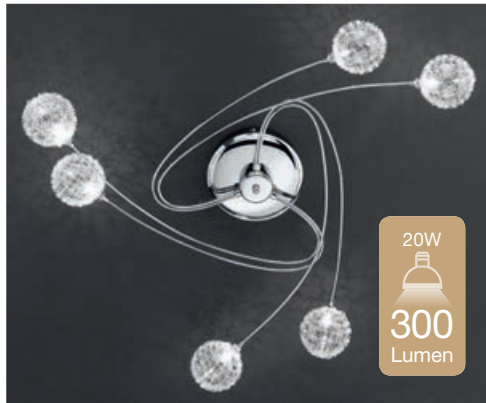

20W
300
Lumen

5 Astro / Serie 360
9360.06.01.0000
EAN4003474231433
Chrom / Chrome

6 x G4 / 12 V / 20 W incl.
2900 K / 6 x 300 lm

Energieeffizienzklasse /
energy efficiency class:

C

Markenleuchtmittel inkl.
branded lamp incl.

Ø 86 cm, ↓ 20 cm
Glas / Glass: 6345, Ø 9 cm

20W
320
Lumen

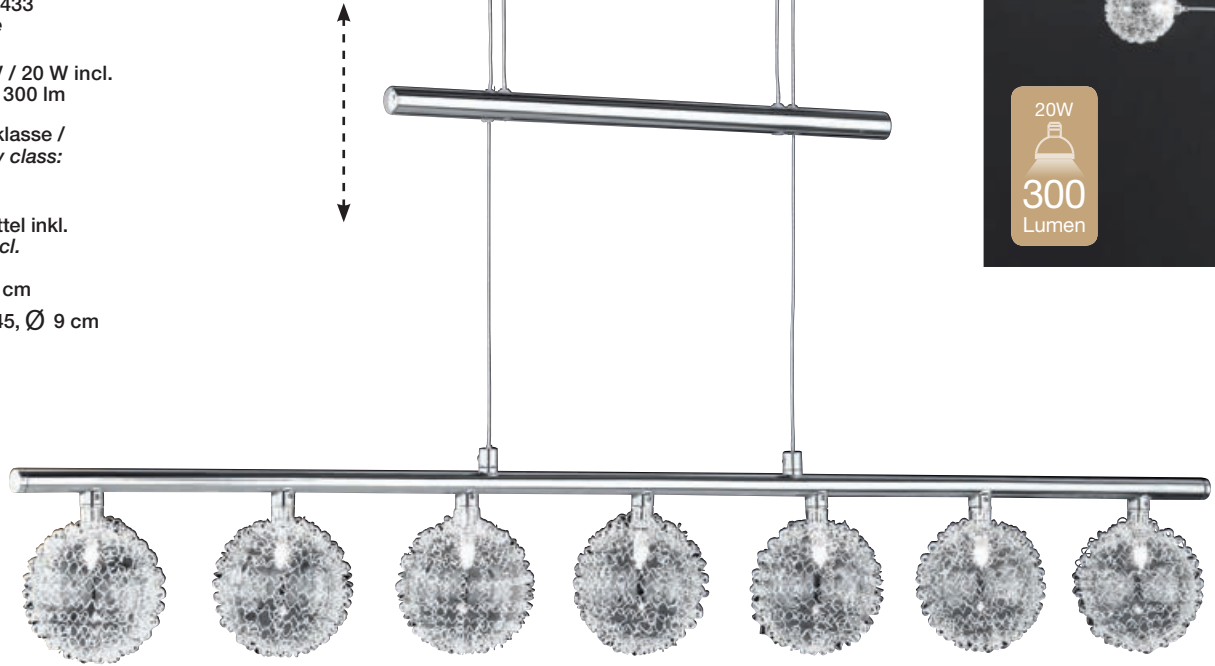

6 Astro / Serie 360
7360.07.01.0000
EAN4003474240510
Chrom / Chrome

7 x G4 / 12 V / 20 W incl.
2800 K / 7 x 320 lm

Energieeffizienzklasse /
energy efficiency class:

C

Markenleuchtmittel inkl.
branded lamp incl.

↑ 150 cm, ↔ 94,5 cm
Glas / Glass: 6345, Ø 9 cm



*Wie Kugelsterne
am Nachthimmel
...Star-like spheres in the
midnight sky*

7 Astro / Serie 360
9360.09.01.0000
EAN4003474231419
Chrom / Chrome

9 x G4 / 12 V / 20 W incl.
2900 K / 9 x 300 lm

Energieeffizienzklasse /
energy efficiency class:

C

Markenleuchtmittel inkl.
branded lamp incl.

Ø 94 cm, ↓ 25 cm
Glas / Glass: 6345, Ø 9 cm

20W
300
Lumen

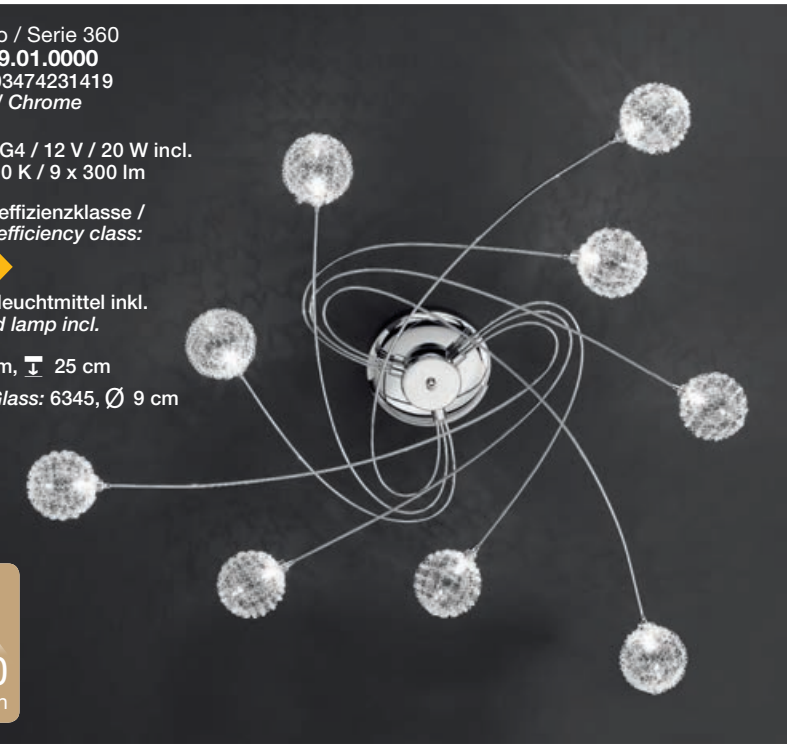

8 Arc / Serie 306
4306.02.01.0000
EAN4003474242507
Chrom / Chrome

2 x G4 / 12 V / 20 W incl.
2800 K / 2 x 320 lm

Energieeffizienzklasse /
energy efficiency class:

C

Markenleuchtmittel inkl.
branded lamp incl.

↑ 50 cm, ↔ 15 cm, → 19 cm
Glas / Glass: 6345, Ø 9 cm

20W
320
Lumen





Kristall-Leuchten

...Crystal lamps

Spiel mit Reflexionen

Ob modern, verspielt oder glamourös: Kristallleuchten sind luxuriöses Wohnelement und schöne Beleuchtung in einem. Mit unseren exklusiven Modellen haben wir den Kronleuchter von damals neu interpretiert. Damit Sie jeden Tag zauberhafte Lichtspiele genießen können.

Playing with reflections

Modern, playful or luxurious: crystal chandeliers are provide a luxurious ambience and beautiful lighting. Our exclusive models reinterpret yesterday's chandelier so you can enjoy magical light effects every day.

Arizona | 058

Marquis | 059

Holly | 059





Von funkelnder Eleganz
...Sparkling elegance



1 Arizona / Serie 225
5225.08.01.0000
EAN4003474207117
Chrom / Chrome
geeignet für / suitable for
/ Energieeffizienzklasse /
energy efficiency class:

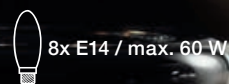

Ø 75 cm, ↑ 150 cm

Glaskristall / glass crystal
89 x Behang / 89 x strings
Glas / Glass: 7931 / 7816



7816



2 Arizona / Serie 225
5225.05.01.0000
EAN4003474209609
Chrom / Chrome
geeignet für / suitable for
/ Energieeffizienzklasse /
energy efficiency class:

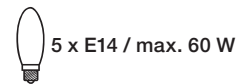

Ø 60 cm, ↑ 150 cm

Glaskristall / glass crystal
46 x Behang / 46 x strings
Glas / Glass: 7931 / 7816



7931

3 Arizona / Serie 225
4225.02.01.0000
EAN4003474219493
Chrom / Chrome
geeignet für / suitable for
/ Energieeffizienzklasse /
energy efficiency class:

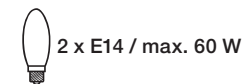

↑ 31 cm, ↔ 40 cm, ↳ 21,5 cm

Glaskristall / glass crystal
12 x Behang / 12 x strings
Glas / Glass: 7931 / 7816



Ein Klassiker voller Raffinesse

Die Serie Arizona verbindet opulente Details aus Glaskristall mit modernen Lichtakzenten.

A blend of classic and modern styles

The ARIZONA series combines luxurious *glass crystal* details with modern light accents.



20W
300
Lumen

1 Marquis / Serie 446
9446.05.01.0000
EAN4003474257068
Chrom / Chrome

5 x G4 / 12 V / 20 W incl.
2900 K / 5 x 300 lm

Energieeffizienzklasse /
energy efficiency class:

C

Ø 32 cm, ↓ 44 cm

Faszinierende Leichtigkeit

Glaskristalle, eingebettet in
filigranes Design aus Chrom.

Enchanting lightness

Glass crystals embedded in
delicately designed chrome.

2 Holly / Serie 568
6568.01.01.0350
EAN4003474242712
Chrom / Chrome
geeignet für / suitable for
Energieeffizienzklasse /
energy efficiency class:

A++



Fit for LED

Ø 35 cm, ↓ 150 cm



3 Holly / Serie 568
9568.01.01.0350
EAN4003474242743
Chrom / Chrome
geeignet für / suitable for
Energieeffizienzklasse /
energy efficiency class:

A++



Fit for LED

Ø 35 cm, ↓ 24 cm

Magische Lichtspiele

...Light effects filled with magic

4 Holly / Serie 568
4568.01.01.0220
EAN4003474246260
Chrom / Chrome
geeignet für / suitable for
Energieeffizienzklasse /
energy efficiency class:

A++



Fit for LED

↓ 21 cm, ← 22 cm, → 14,5 cm



5 Holly / Serie 568
8568.01.01.0130
EAN4003474245782
Chrom / Chrome

1 x G9 / 28 W incl.
2800 K / 1 x 370 lm

Energieeffizienzklasse /
energy efficiency class:

C

HALBGER
EDG

Ø 13 cm, ↓ 17 cm

Glas / Glass: 6507, Ø 13 cm



28W
370
Lumen





Höhenverstellbare Pendelleuchten

...Height adjustable pendants

Aktuelles für den Wohlfühlbereich

Die richtige Beleuchtung ist ein wichtiges Mittel bei der Raumgestaltung. Unsere Pendelleuchten sind über Arbeitsflächen oder Esstischen nicht nur äußerst nützlich, sie strahlen immer auch eine gewisse Wärme aus, die Behaglichkeit schafft.

The latest for your comfort zone

Perfect light is an important tool for great interior design. Our pendants aren't just useful above work areas and dining room tables – they also radiate a sense of comfort and warmth.

Evry 062	Savannah 070
Mission 062	Santa Fee 071
Layton 063	Augusta 071
Freya 063	Sacramento 071
Darwin 064	Point 072
Laurids 064	Zoon 073
Vileta 065	Flame 073
Lara 065	Clara 073
Roma 066	Chateau 073
Nero 066	Mali 074
Atlanta 067	weitere
Talas 067	höhenverstellbare
Ava 068	Pendelleuchten
Madison 068	additional height
Parker 068	adjustable
Georgia 069	pendants 075

1 Evry / Serie 420
7420.04.64.0000
 EAN4003474281865
 Nickel-matt / Nickel matt finished

 4 x LED / 5 W incl.
 3000 K / 4 x 400 lm

Energieeffizienzklasse /
 energy efficiency class:

A+

Markenleuchtmittel inkl.
 branded lamp incl.

↑ 150 cm, ↔ 80 cm, ↗ 8 cm

Glas / Glass: 1407



 5W
400
 Lumen



Leuchten für Generationen

Zukunftsweisende Technologie verknüpft mit schlichter
 und klassischer Eleganz

Lighting for generations

Cutting edge technology combined with simple and
 classic elegance

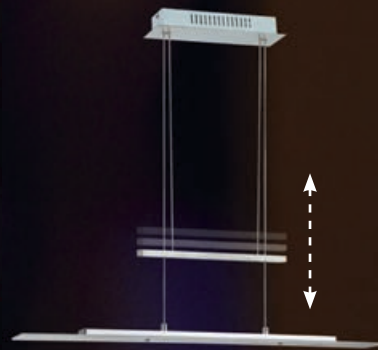

 33W
2100
 Lumen

beleuchtet
 illuminated

Neu!
Neu!

Schlichte klassische Eleganz
 ...Simple but classic elegance

2 Mission / Serie 509
7509.02.54.0000
 EAN4003474303109
 Nickel-matt / Chrom /
 Nickel matt finished / Chrome

 33 W LED incl.
 3000 K / 2100 lm

Energieeffizienzklasse /
 energy efficiency class:

A

Markenleuchtmittel inkl.
 branded lamp incl.

↑ 150 cm, ↔ 90 cm, ↗ 10 cm

Glas / Glass: 1159, ↔ 90 cm,
 ↑ 3,7 cm, ↗ 12 cm



LED Light
 by **WOFI**

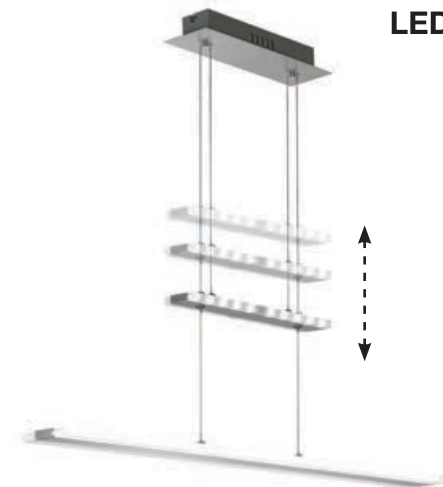

21W
1600
Lumen

1 Freya / Serie 145
7145.01.01.0000
EAN4003474305264
Chrom / Chrome

 1 x LED / 21 W incl.
3000 K / 1 x 1600 lm

Energieeffizienzklasse /
energy efficiency class:

A

Markenleuchtmittel inkl.
branded lamp incl.

↓ 150 cm, ↔ 120 cm, ↗ 8 cm



2 Layton / Serie 908
7908.01.01.0000
EAN4003474304779
Chrom / Chrome

 1 x LED / 26 W incl.
3000 K / 1 x 2200 lm

Energieeffizienzklasse /
energy efficiency class:

A

Markenleuchtmittel inkl.
branded lamp incl.

↓ 150 cm, ↔ 100 cm, ↗ 8 cm

Dimmbar mittels geeignetem
Wanddimmer / dimmable by
suitable wall dimmer



26W
2200
Lumen

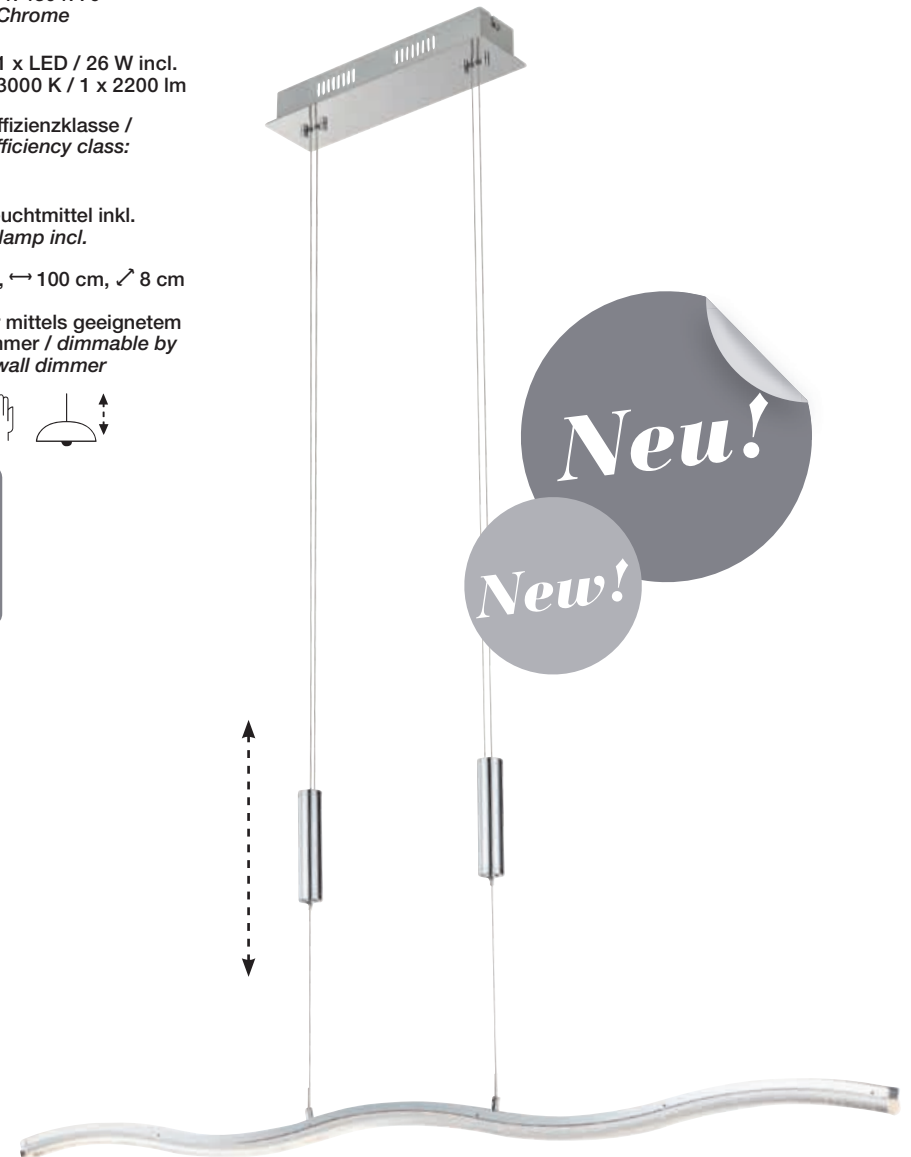

LED Light
by **WOFI**

1 Darwin / Serie 613

7613.03.64.0000

EAN4003474111186

Nickel-matt /

Nickel matt finished



3 x LED / 4,8 W incl.
3000 K / 3 x 410 lm

Energieeffizienzklasse /
energy efficiency class:

A⁺

Markenleuchtmittel inkl.
branded lamp incl.

┌ 150 cm, ↔ 57 cm

Glas: satiniert / Glass: satined

Glas / Glass: 6269

┌ 11 cm, ↔ 8 cm

Dimmbar mittels geeig-
netem Wanddimmer /
dimmable by suitable
wall dimmer



Helle Momente an jeder Ecke

...Bright moments in every corner

4,8W



410

Lumen

LED Light
by **WOFI**

2 Darwin / Serie 613

7613.04.64.0000

EAN4003474268781

Nickel-matt /

Nickel matt finished



4 x LED / 4,8 W incl.
3000 K / 4 x 410 lm

Energieeffizienzklasse /
energy efficiency class:

A⁺

Markenleuchtmittel inkl.
branded lamp incl.

┌ 150 cm, ↔ 80 cm

Glas: satiniert / Glass: satined
Glas / Glass: 6269

┌ 11 cm, ↔ 8 cm

Dimmbar mittels geeignetem Wand-
dimmer / dimmable by suitable
wall dimmer



4,8W



410

Lumen

3 Laurids / Serie 889

7889.04.64.0000

EAN4003474198170

Nickel-matt /

Nickel matt finished



4 x LED / 6 W incl.
3000 K / 4 x 400 lm

Energieeffizienzklasse /
energy efficiency class:

A

Markenleuchtmittel inkl.
branded lamp incl.

┌ 150 cm, ↔ 80 cm, ↗ 12 cm

Dimmbar mittels geeignetem
Wanddimmer / dimmable by
suitable wall dimmer



6W



400

Lumen

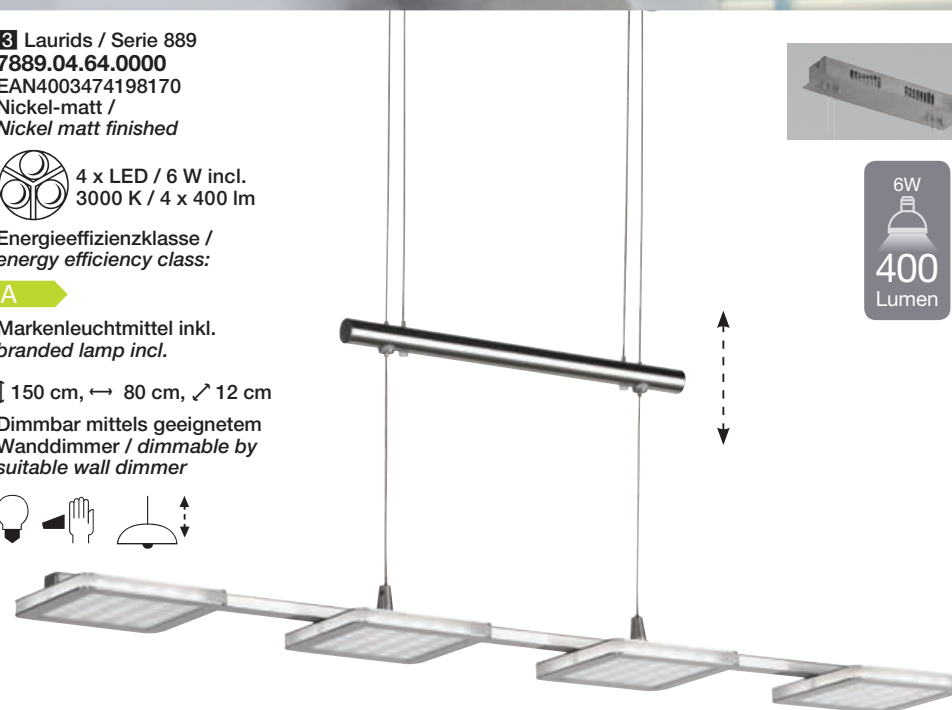



Auf das Wesentliche reduziert

...Reduced to the max

1 Vileta / Serie 254
7254.05.64.0000
 EAN4003474281957
 Nickel-matt /
 Nickel matt finished

 5 x LED / 4,5 W incl.
 3000 K / 5 x 360 lm

Energieeffizienzklasse /
 energy efficiency class:

A⁺

Markenleuchtmittel inkl.
 branded lamp incl.

↓ 120 cm, ↔ 100 cm

Glas / Glass: 3037
 ↔ 12 cm, ↓ 9 cm

Dimmbar mittels geeignetem
 Wanddimmer / dimmable by
 suitable wall dimmer



4,5W

360
 Lumen

3 Lara / Serie 090
7090.05.01.0000
 EAN4003474302492
 Chrom / Chrome

 5 x LED / 5 W incl.
 3000 K / 5 x 400 lm

Energieeffizienzklasse /
 energy efficiency class:

A

Markenleuchtmittel inkl.
 branded lamp incl.

↓ 150 cm, ↔ 76 cm

Glas / Glass: 6299
 ↔ 9,3 cm, ↓ 3 cm

Dimmbar mittels geeignetem
 Wanddimmer / dimmable by
 suitable wall dimmer



Neu!
New!



5W

400
 Lumen

LED Light
 by **WOFI**

Innovativer Klassiker

...innovative classics



21,6W
1800
Lumen

1 Roma / Serie 120
6120.01.54.0000
EAN4003474291048
Nickel-matt / Chrom
Nickel matt finished / Chrome

 1 x LED / 21,6 W incl.
3000 K / 1 x 1800 lm

Energieeffizienzklasse /
energy efficiency class:

A

Markenleuchtmittel inkl.
branded lamp incl.

Ø 35 cm, ↑ 150 cm
Glas / Glass: 6377

Dimmbar mittels geeignetem
Wanddimmer / dimmable by
suitable wall dimmer



4,2W
400
Lumen

LED Light
by **WOFI**

2 Nero / Serie 277
6277.05.64.0000
EAN4003474290034
Nickel-matt /
Nickel matt finished

 5 x LED / 4,2 W incl.
3000 K / 5 x 400 lm

Energieeffizienzklasse /
energy efficiency class:

A+

Markenleuchtmittel inkl.
branded lamp incl.

↑ 150 cm, ↔ 100 cm, ↗ 6 cm
Dimmbar mittels geeignetem
Wanddimmer / dimmable by
suitable wall dimmer



3 Nero / Serie 277
6277.05.22.0000
EAN4003474291055
Messing modern / Brass modern

 5 x LED / 4,2 W incl.
2700 K / 5 x 400 lm

Energieeffizienzklasse /
energy efficiency class:

A+

Markenleuchtmittel inkl.
branded lamp incl.

↑ 150 cm, ↔ 100 cm, ↗ 6 cm
Dimmbar mittels geeignetem
Wanddimmer /
dimmable by suitable wall dimmer

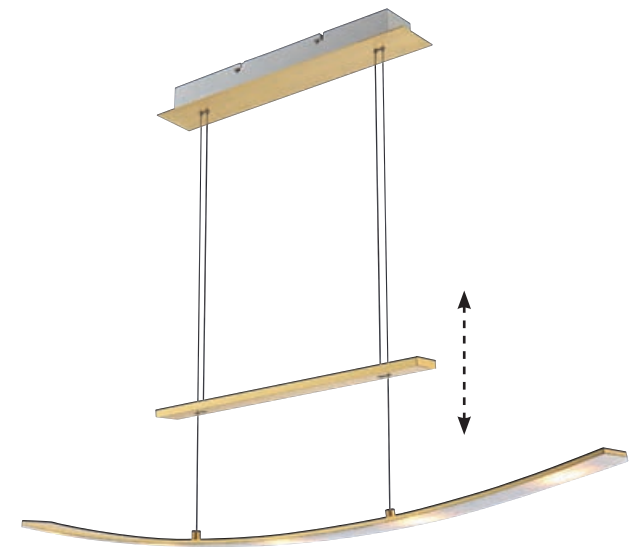

1 Atlanta / Serie 886

7886.05.64.0000

EAN4003474237251

Nickel-matt /

Nickel matt finished



5 x LED / 5 W incl.
3000 K / 5 x 420 lm

Energieeffizienzklasse /
energy efficiency class:

A+

Markenleuchtmittel inkl.
branded lamp incl.

↓ 150 cm, ↔ 85 cm, ↗ 41 cm

Glas: weiß lackiert mit Klarrand /
Glass: white lacquered with clear
border

Glas / Glass: 3051, ↔ 7,5 cm

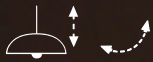

5W
420
Lumen



2 Talas / Serie 596

7596.04.64.0000

EAN4003474235639

Nickel-matt /

Nickel matt finished



4 x LED / 5 W incl.
3000 K / 4 x 420 lm

Energieeffizienzklasse /
energy efficiency class:

A+

Markenleuchtmittel inkl.
branded lamp incl.

↓ 150 cm, ↔ 75 cm, ↗ 37 cm

Glas: opal weiß / Glass: opal white
Glas / Glass: 6312, ↔ 7 cm



5W
420
Lumen

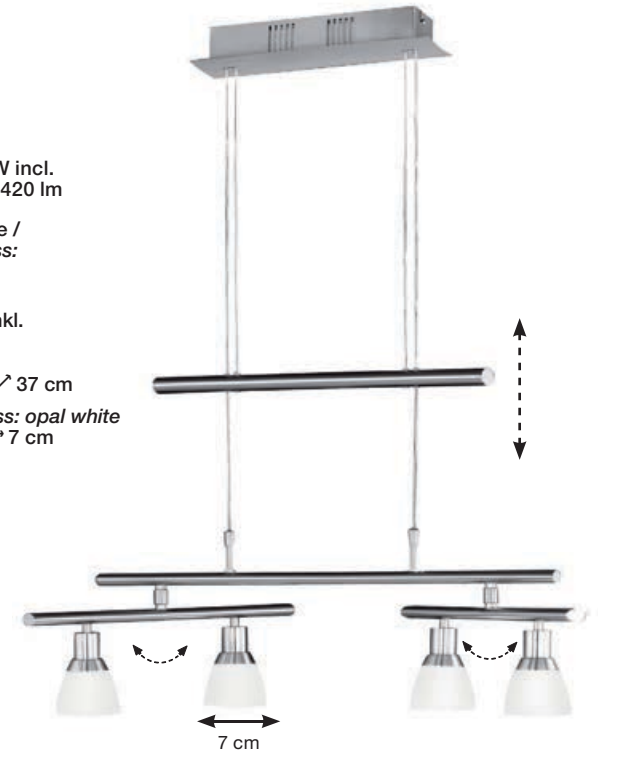

3 Talas / Serie 596

7596.06.64.0000

EAN4003474235509

Nickel-matt /

Nickel matt finished



6 x LED / 5 W incl.
3000 K / 6 x 420 lm

Energieeffizienzklasse /
energy efficiency class:

A+

Markenleuchtmittel inkl.
branded lamp incl.

↓ 150 cm, ↔ 115 cm, ↗ 37 cm

Glas: opal weiß / Glass: opal white
Glas / Glass: 6312, ↔ 7 cm

Dimmbar mittels geeignetem
Wanddimmer / dimmable by
suitable wall dimmer



5W
420
Lumen

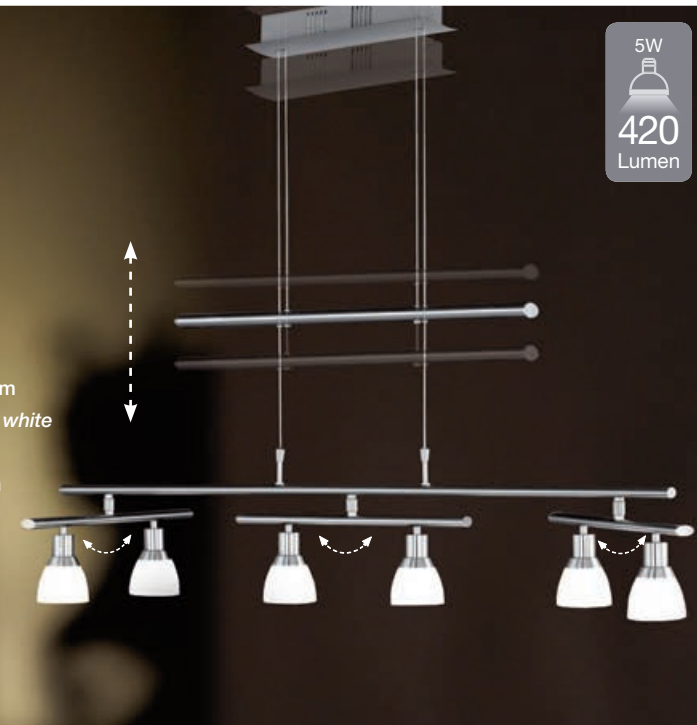

1 Ava / Serie 270
7270.04.64.0000
 EAN4003474268804
 Nickel-matt / *Nickel matt finished*

LED Light
 by **WOFI**

 4 x LED / 4,8 W incl.
 3000 K / 4 x 410 lm

Energieeffizienzklasse /
energy efficiency class:

A+

Markenleuchtmittel inkl.
branded lamp incl.

↑ 150 cm, ↔ 80 cm

Glas: opal weiß /
Glass: opal white
 Glas / *Glass:* 6232, ↔ 13,5 cm

Dimmbar mittels geeignetem Wand-
 dimmer / *dimnable by suitable wall*
dimmer



4,8W

410
 Lumen



2 Madison / Serie 942
7942.04.64.0100
 EAN4003474183510
 Nickel-matt / *Nickel matt*
finished

 4 x GY6,35 / 12 V /
 35 W incl.
 2900 K / 4 x 580 lm

Energieeffizienzklasse /
energy efficiency class:

C

Markenleuchtmittel inkl.
branded lamp incl.

↑ 150 cm, ↔ 73 cm

Glas: weiß satiniert /
Glass: white satin
 Glas / *Glass:* 7633, ↔ 9 cm



35W

580
 Lumen

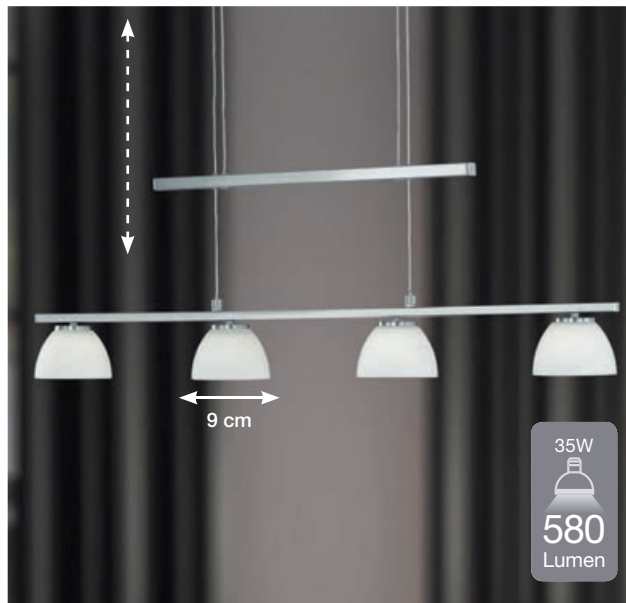

3 Parker / Serie 988
7988.04.01.0100
 EAN4003474251660
 Chrom / *Chrome*

 4 x GY6,35 / 12 V / 35 W incl.
 2900 K / 4 x 580 lm

Energieeffizienzklasse /
energy efficiency class:

C

Markenleuchtmittel inkl. /
branded lamp incl.

↑ 150 cm, ↔ 72 cm

Glas: weiß gewischt /
Glass: white wipe-technique
 Glas / *Glass:* 7811,
 Ø 9 cm, ↑ 7,5 cm



35W

580
 Lumen



Leuchten für mehr Behaglichkeit

...Lamps to increase your comfort



1 Georgia / Serie 664
7664.04.64.0000
 EAN4003474201443
 Nickel-matt / Nickel matt finished

 4 x GY6,35 / 12 V / 35 W incl.
 2900 K / 4 x 860 lm

Energieeffizienzklasse /
 energy efficiency class:

B

Markenleuchtmittel inkl.
 branded lamp incl.



↓ 150 cm, ↔ 110 cm

Glas: opal weiß / Glass: opal white
 Glas / Glass: 7766, Ø 14 cm
 6045, Ø 2,6 cm



6045
 innen / inside

35W

860
 Lumen

2 Georgia / Serie 664
7664.02.64.0000
 EAN4003474201405
 Nickel-matt /
 Nickel matt finished

 2 x GY6,35 / 12 V /
 35 W incl.
 2900 K / 2 x 860 lm

Energieeffizienzklasse /
 energy efficiency class:

B

Markenleuchtmittel inkl.
 branded lamp incl.



↓ 150 cm, ↔ 45 cm

Glas: opal weiß / Glass: opal white
 Glas / Glass: 7766, Ø 14 cm
 6045, Ø 2,6 cm



3 Georgia / Serie 664
7664.03.64.0000
 EAN4003474201429
 Nickel-matt /
 Nickel matt finished

 3 x GY6,35 / 12 V /
 35 W incl.
 2900 K / 3 x 860 lm

Energieeffizienzklasse /
 energy efficiency class:

B

Markenleuchtmittel inkl.
 branded lamp incl.



↓ 150 cm, ↔ 80 cm

Glas: opal weiß /
 Glass: opal white
 Glas / Glass: 7766, Ø 14 cm
 6045, Ø 2,6 cm





LED Light
by WOFI®

1 Savannah / Serie 722
7722.02.64.0006
EAN4003474209203
Nickel-matt /
Nickel matt finished
2 x E14 LED / 4 W incl.
3000 K / 2 x 320 lm

Energieeffizienzklasse /
energy efficiency class:

A+

Markenleuchtmittel inkl. /

branded lamp incl.

∓ 150 cm, ↔ 60 cm

Glas: weiß gewischt /
Glass: white wipe-technique
Glas / Glass: 7724, ↔ 18 cm



2 Savannah / Serie 722
6722.01.64.0006
EAN4003474209173
Nickel-matt /
Nickel matt finished

1 x E14 LED / 4 W incl.
3000 K / 1 x 320 lm

Energieeffizienzklasse /
energy efficiency class:

A+

Markenleuchtmittel inkl. /
branded lamp incl.

∅ 18 cm, ∓ 150 cm

Glas: weiß gewischt /
Glass: white wipe-technique
Glas / Glass: 7724, ↔ 18 cm

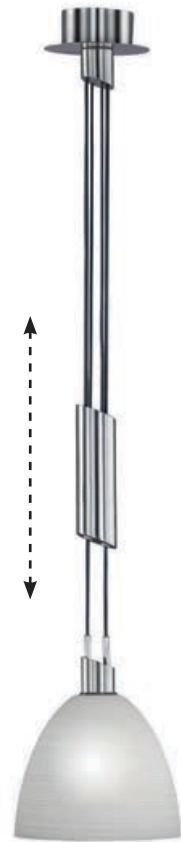

*Der Materialmix
macht's
...Its all in the mix*

3 Savannah / Serie 722
7722.03.64.0006
EAN4003474209234
Nickel-matt / Nickel matt finished

3 x E14 LED / 4 W incl.
3000 K / 3 x 320 lm

Energieeffizienzklasse /
energy efficiency class:

A+

Markenleuchtmittel inkl. /
branded lamp incl.

∓ 150 cm, ↔ 100 cm

Glas: weiß gewischt /
Glass: white wipe-technique
Glas / Glass: 7724, ↔ 18 cm



4W
320
Lumen



33W
460
Lumen

1 Santa Fee / Serie 399
7399.04.64.0000
EAN4003474180830
Nickel-matt /
Nickel matt finished

4 x G9 / 33 W incl.
2700 K / 4 x 460 lm

Energieeffizienzklasse /
energy efficiency class:

D

Markenleuchtmittel inkl.
branded lamp incl.

HALOGEN
EGD

↑ 150 cm, ↔ 90 cm, ↗ 34 cm

Glas: Alabasterfarbig /
Glass: Alabaster coloured
7170, Ø 18 cm, ↑ 3,7 cm
7171, Ø 8 cm, ↑ 7,5 cm

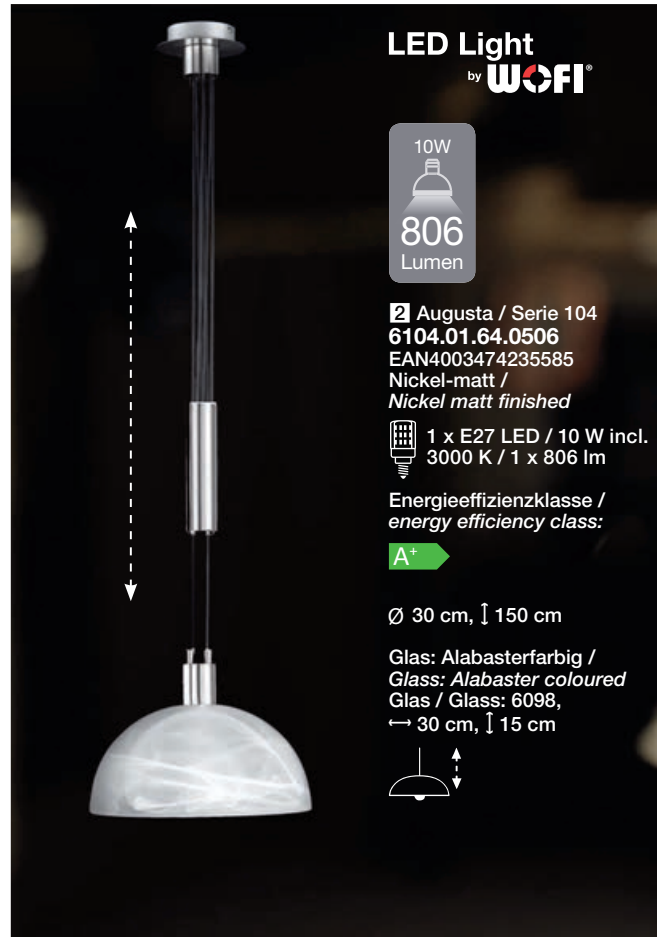

LED Light
by **WOFI**

10W
806
Lumen

2 Augusta / Serie 104
6104.01.64.0506
EAN4003474235585
Nickel-matt /
Nickel matt finished

1 x E27 LED / 10 W incl.
3000 K / 1 x 806 lm

Energieeffizienzklasse /
energy efficiency class:

A+

Ø 30 cm, ↑ 150 cm

Glas: Alabasterfarbig /
Glass: Alabaster coloured
Glas / Glass: 6098,
↔ 30 cm, ↑ 15 cm



3 Sacramento / Serie 744
7744.03.64.0000
EAN4003474195698
Nickel-matt /
Nickel matt finished

3 x G9 / 48 W incl.
2800 K / 3 x 740 lm

Energieeffizienzklasse /
energy efficiency class:

D

Markenleuchtmittel inkl.
branded lamp incl.

HALOGEN
EGD

↑ 150 cm, ↔ 100 cm

Glas: weiß satiniert / Glass: white satin
Glas / Glass: 7642, ↔ 25 cm



48W
740
Lumen



1 Point / Serie 248
6248.01.64.0200
 EAN4003474128733
 Nickel-matt /
Nickel matt finished
 geeignet für / suitable for /
 Energieeffizienzklasse /
 energy efficiency class:



Fit for LED

Ø 20 cm, ↓ 160 cm

Glas: opal weiß /
 Glass: opal white
 Glas / Glass: 1621

2 Point / Serie 248
6248.01.64.0250
 EAN4003474128740
 Nickel-matt /
Nickel matt finished
 geeignet für / suitable for /
 Energieeffizienzklasse /
 energy efficiency class:



Fit for LED

Ø 25 cm, ↓ 160 cm

Glas: opal weiß /
 Glass: opal white
 Glas / Glass: 1625

3 Point / Serie 248
6248.01.64.0300
 EAN4003474128757
 Nickel-matt /
Nickel matt finished
 geeignet für / suitable for /
 Energieeffizienzklasse /
 energy efficiency class:



Fit for LED

Ø 30 cm, ↓ 160 cm

Glas: opal weiß /
 Glass: opal white
 Glas / Glass: 1631

4 Point / Serie 248
6248.01.64.0350
 EAN4003474131450
 Nickel-matt /
Nickel matt finished
 geeignet für / suitable for /
 Energieeffizienzklasse /
 energy efficiency class:



Fit for LED

Ø 35 cm, ↓ 160 cm

Glas: opal weiß /
 Glass: opal white
 Glas / Glass: 1633



1 Zoon / Serie 192
6192.01.01.0000
 EAN4003474269436
 Chrom / *Chrome*
 geeignet für / *suitable for* /
 Energieeffizienzklasse /
 energy efficiency class:

Fit for LED
 Ø 30 cm, ↑ 150 cm,
 Glas weiß mit Spiraldekor /
*Glass white with spiral
 decoration*
 Glas / Glass: 6173

A++ **E**

1 x E27 /
 max.60 W



3 Clara / Serie 804
6804.01.64.0000
 EAN4003474152752
 Nickel-matt / *Nickel matt
 finished*
 geeignet für / *suitable for* /
 Energieeffizienzklasse /
 energy efficiency class:

Fit for LED
 Ø 20 cm, ↑ 150 cm
 Glas / Glass: 7376,
 ↔ 20 cm

A++ **E**

1 x E27 /
 max.60 W



2 Flame / Serie 141
6141.01.64.0000
 EAN4003474169200
 Nickel-matt /
Nickel matt finished
 geeignet für / *suitable for* /
 Energieeffizienzklasse /
 energy efficiency class:

Fit for LED
 Ø 12 cm, ↑ 150 cm
 Glas: opal weiß /
Glass: opal white
 Glas / Glass: 7054
 ↔ 11 cm, ↑ 20,5 cm,

A++ **E**

1 x E27 /
 max.60 W



4 Chateau / Serie 494
6494.01.01.0000
 EAN4003474259550
 Chrom / *Chrome*
 geeignet für / *suitable for* /
 Energieeffizienzklasse /
 energy efficiency class:

Fit for LED
 Ø 26 cm, ↑ 150 cm
 Glas: weiß glänzend
Glass: white shiny
 Glas / Glass: 6078,
 Ø 25 cm

A++ **E**

1 x E27 /
 max.60 W

Eine perfekte Silhouette
 ...A perfect silhouette



1 Mali / Serie 204
7204.04.64.0000
 EAN4003474140162
 Nickel-matt /
Nickel matt finished
 geeignet für / suitable for /
 Energieeffizienzklasse /
 energy efficiency class:

A++  **E**

  4 x E14 /
 max. 40 W

Fit for LED

↑ 150 cm, ↔ 81 cm

Glas: opal weiß /
 Glass: opal white
 Glas / Glass: 6424,
 Ø 11,5 cm, ↑ 10 cm



2 Mali / Serie 204
7204.05.64.0000
 EAN4003474140179
 Nickel-matt /
Nickel matt finished
 geeignet für / suitable for /
 Energieeffizienzklasse /
 energy efficiency class:

  5 x E14 /
 max. 40 W

Fit for LED

↑ 150 cm, ↔ 105 cm,

Glas: opal weiß /
 Glass: opal white
 Glas / Glass: 6424,
 Ø 11,5 cm, ↑ 10 cm

3 Mali / Serie 204
7204.03.64.0000
 EAN4003474140155
 Nickel-matt /
Nickel matt finished
 geeignet für / suitable for /
 Energieeffizienzklasse /
 energy efficiency class:

A++  **E**

  3 x E14 /
 max. 40 W

Fit for LED

↑ 150 cm, ↔ 57 cm

Glas: opal weiß /
 Glass: opal white
 Glas / Glass: 6424,
 Ø 11,5 cm, ↑ 10 cm



Weitere attraktive Pendelleuchten finden Sie unter der Kategorie „Produktfamilien“ auf folgenden Seiten:
 Additional attractive pendants please find in the category „product families“ on the following pages:



Vannes / Serie 625
7625.01.01.0000
 Seite / Page 011 / 012



Colmar / Serie 234
7234.01.01.0000
 Seite / Page 015



Louvre / Serie 825
7825.01.54.0000
 Seite / Page 017



Louvre / Serie 825
7825.01.54.1000
 Seite / Page 017

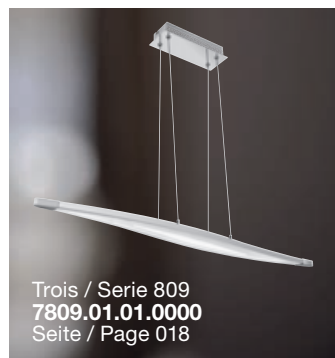

Trois / Serie 809
7809.01.01.0000
 Seite / Page 018



Avignon / Serie 275
7275.01.64.0000
 Seite / Page 019



Galax / Serie 587
7587.01.01.0000
 Seite / Page 020

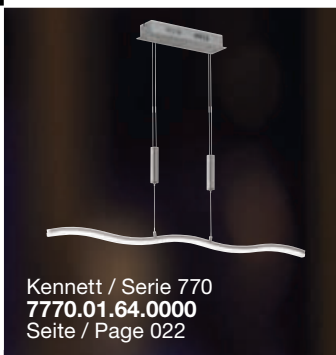

Kennett / Serie 770
7770.01.64.0000
 Seite / Page 022



Sorel / Serie 524
6524.01.01.0000
 Seite / Page 023



Napa / Serie 666
6666.01.64.0000
 Seite / Page 024



Horton / Serie 786
7786.01.54.0000
 Seite / Page 025

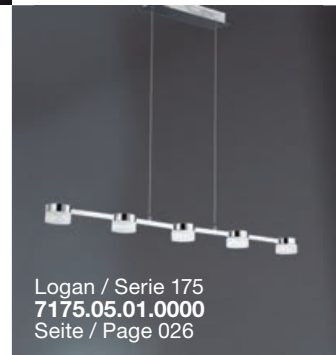

Logan / Serie 175
7175.05.01.0000
 Seite / Page 026



Hook / Serie 893
7893.06.54.0000
 Seite / Page 027

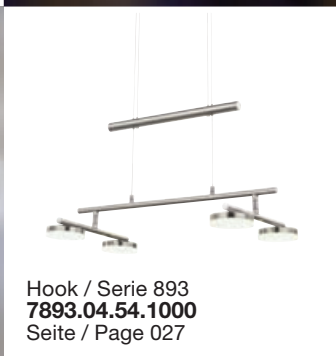

Hook / Serie 893
7893.04.54.1000
 Seite / Page 027



Davis / Serie 507
7507.04.54.1000
 Seite / Page 028



Segura / Serie 162
7162.03.76.0000
 Seite / Page 029

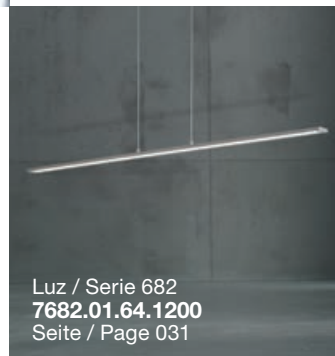

Luz / Serie 682
7682.01.64.1200
 Seite / Page 031



Mercur / Serie 313
7313.01.01.0000
 Seite / Page 031



Banks / Serie 404
7404.02.76.0000
 Seite / Page 032



Maar / Serie 806
7806.05.01.0000
 Seite / Page 043



Astro / Serie 360
7360.04.01.0000
 Seite / Page 054



Astro / Serie 360
7360.07.01.0000
 Seite / Page 055



Stand- und Tischleuchten

...Floor and table lamps

Solisten für intensive Lichtmomente

Klassisches Design trifft auf die Technologie von Morgen: Mit stilvollen Leuchten, ausgestattet mit neuester Technik, lassen sich einzelne Lichtzonen perfekt gestalten.

Soloists for intense lighting moments

Time-honoured design meets tomorrow's technology: These stylish lights are equipped with the latest technology and allow you to design individual lighting zones within your rooms.

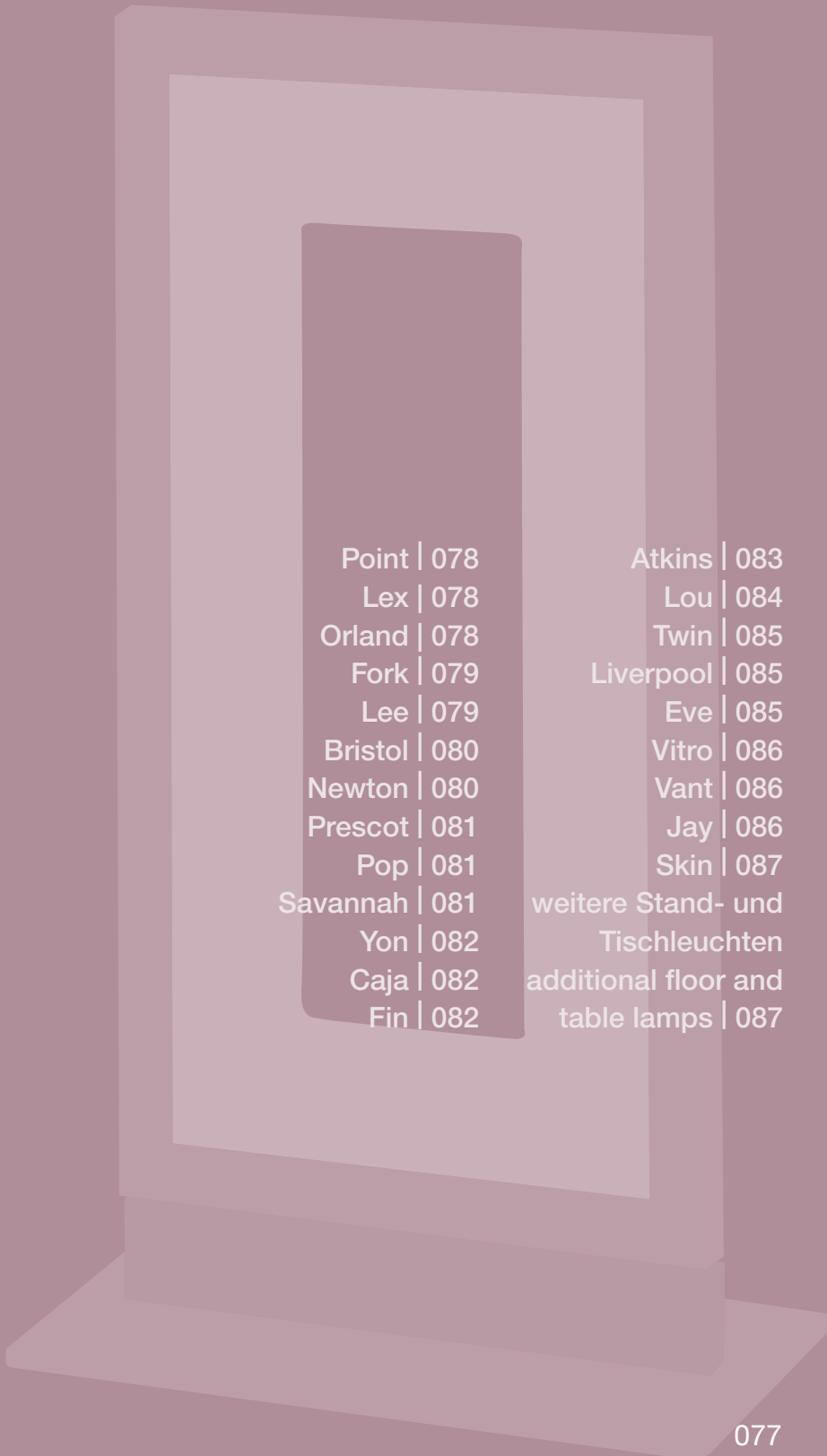

Point 078	Atkins 083
Lex 078	Lou 084
Orland 078	Twin 085
Fork 079	Liverpool 085
Lee 079	Eve 085
Bristol 080	Vitro 086
Newton 080	Vant 086
Prescot 081	Jay 086
Pop 081	Skin 087
Savannah 081	weitere Stand- und Tischleuchten
Yon 082	additional floor and table lamps 087
Caja 082	
Fin 082	



Dazugehörige
Pendel finden Sie
auf Seite 72

You'll find matching
pendants on page 72

1 Point / Serie 248
8248.01.06.0250
EAN4003474128481
Weiß / White
geeignet für / suitable for /
Energieeffizienzklasse /
energy efficiency class:

A++ E

1 x E27 /
max. 60 W

Fit for LED

Ø 25 cm

Glas: opal weiß /
Glass: opal white



2 Point / Serie 248
8248.01.06.0200
EAN4003474128474
Weiß / White
geeignet für / suitable for /
Energieeffizienzklasse /
energy efficiency class:

A++ E

1 x E27 /
max. 40 W

Fit for LED

Ø 20 cm

Glas: opal weiß /
Glass: opal white



3 Point / Serie 248
8248.01.06.0300
EAN4003474128498
Weiß / White
geeignet für / suitable for /
Energieeffizienzklasse /
energy efficiency class:

A++ E

1 x E27 /
max. 60 W

Fit for LED

Ø 30 cm

Glas: opal weiß /
Glass: opal white



Rundum gelungen

...A well-rounded beauty

LED Light
by **WOFI**

4 Lex / Serie 024
8024.01.01.0000
EAN4003474286129
Chrom / Chrome

1 x LED / 11 W incl.
3000 K / 1 x 800 lm

Energieeffizienzklasse /
energy efficiency class:

A

Markenleuchtmittel inkl.
branded lamp incl.

↔ 70 cm, ↓ 35 cm

3-Stufen dimmbar
3-step dimmable

11W
800
Lumen



Neu!

Neu!

5 Orland / Serie 510
8510.01.01.0000
EAN4003474301891
Chrom / Chrome

1 x LED / 10 W incl.
3000 K / 1 x 700 lm

Energieeffizienzklasse /
energy efficiency class:

A

Markenleuchtmittel inkl.
branded lamp incl.

↔ 37 cm, ↓ 40 cm



10W
700
Lumen

New!

New!

1 Fork / Serie 593
8593.01.54.0000
EAN4003474302102
Nickel-matt/Chrom /
Nickel-matt finished/Chrome

 1 x LED / 7 W incl.
3000 K / 1 x 400 lm

Energieeffizienzklasse /
energy efficiency class:

A

Markenleuchtmittel inkl.
branded lamp incl.

┆ 25 cm, ↔ 14 cm, ↗ 8 cm



7W

400
Lumen

6W

385
Lumen

2 Lee / Serie 592
8592.01.54.0200
EAN4003474301969
Nickel-matt/Chrom /
Nickel-matt finished/Chrome

 1 x LED / 6 W incl.
3000 K / 1 x 385 lm

Energieeffizienzklasse /
energy efficiency class:

A

Markenleuchtmittel inkl.
branded lamp incl.

┆ 23 cm, ↔ 20 cm, ↗ 10 cm



3,5W

205
Lumen

3 Lee / Serie 592
8592.01.54.0120
EAN4003474301952
Nickel-matt/Chrom /
Nickel-matt finished/Chrome

 1 x LED / 3,5 W incl.
3000 K / 1 x 205 lm

Energieeffizienzklasse /
energy efficiency class:

A

Markenleuchtmittel inkl.
branded lamp incl.

┆ 15 cm, ↔ 12 cm, ↗ 5 cm



Zeitlose Accessoires
...timeless accessories



Es gibt Formen, die kann man nicht verbessern
 ...Some shapes can't be improved

1 Newton / Serie 112
8112.02.32.0010
 EAN4003474235561
 Messing-matt /
Brass matt finished
 geeignet für / suitable for /
 Energieeffizienzklasse /
 energy efficiency class:

A++ 

 2 x E14 / max. 40 W

2 Bristol / Serie 111
8111.02.64.0510
 EAN4003474235554
 Nickel-matt /
Nickel matt finished
 geeignet für / suitable for /
 Energieeffizienzklasse /
 energy efficiency class:

A++ 

 2 x E14 / max. 40 W



3 Newton / Serie 112
8112.02.64.0010
 EAN4003474236308
 Nickel-matt /
Nickel matt finished
 geeignet für / suitable for /
 Energieeffizienzklasse /
 energy efficiency class:

A++ 

 2 x E14 / max. 40 W

Fit for LED

↑ 39 cm, ↔ 32 cm

Glas: weiß lackiert /
Glass: white lacquered
 Glas / Glass: 6314,
 ↔ 32 cm, ↓ 10 cm





4 Bristol / Serie 111
8111.02.32.0510
 EAN4003474236285
 Messing-matt /
Brass matt finished
 geeignet für / suitable for /
 Energieeffizienzklasse /
 energy efficiency class:

A++ 

 2 x E14 / max. 40 W

Fit for LED

Ø 25,5 cm, ↑ 37 cm

Glas: Alabasterfarbig /
Glass: Alabaster coloured
 Glas / Glass: 1360,
 Ø 25,5 cm, ↓ 8,5 cm





1 Prescott / Serie 747
8747.02.64.0000
 EAN4003474179568
 Nickel-matt /
Nickel matt finished
 geeignet für / suitable for
 / Energieeffizienzklasse /
 energy efficiency class:

A++ E

2 x E14 / max. 40 W

Ø 27,5 cm, ↑ 42 cm

Glas: weiß lackiert /
Glass: white lacquered
 Glas / Glass: 7550,
 Ø 27,5 cm, ↑ 9 cm



2 Pop / Serie 865
8865.02.64.0000
 EAN4003474156378
 Nickel-matt /
Nickel matt finished
 geeignet für / suitable for
 / Energieeffizienzklasse /
 energy efficiency class:

A++ E

2 x E14 / max. 40 W

Ø 19 cm, ↑ 38 cm

Glas: opal weiß /
Glass: opal white
 Glas / Glass: 7377,
 Ø 19 cm, ↑ 10 cm



3 Savannah / Serie 722
8722.01.64.0006
 EAN4003474228334
 Nickel-matt /
Nickel matt finished

1 x E14 / max. 4 W incl.
 3000 K / 1 x 320 lm

Energieeffizienzklasse /
 energy efficiency class:

A+

Markenleuchtmittel inkl. /
 branded lamp incl.

↑ 45 cm

Glas: weiß gewischt /
Glass: white wipe-
technique
 Glas / Glass: 7724,
 Ø 18 cm, ↑ 14 cm



LED Light
 by **WOFI**



4 Prescott / Serie 747
8747.02.01.0000
 EAN4003474196268
 Chrom / *Chrome*
 geeignet für / suitable for
 / Energieeffizienzklasse /
 energy efficiency class:

A++ E

2 x E14 / max. 40 W

Ø 27,5 cm, ↑ 42 cm

Glas: weiß lackiert /
Glass: white lacquered
 Glas / Glass: 7550,
 Ø 27,5 cm, ↑ 9 cm



5 Pop / Serie 865
8865.02.32.0000
 EAN4003474156361
 Messing-matt /
Brass matt finished
 geeignet für / suitable for
 / Energieeffizienzklasse /
 energy efficiency class:

A++ E

2 x E14 / max. 40 W

Ø 19 cm, ↑ 38 cm

Glas: opal weiß /
Glass: opal white
 Glas / Glass: 7377,
 Ø 19 cm, ↑ 10 cm





5,5W
420
Lumen

LED Light
by WOFI

1 Yon / Serie 025
8025.01.06.0000
EAN4003474287652
Weiß / White

1 x LED / 5,5 W incl.
3000 K / 1 x 420 lm

Energieeffizienzklasse /
energy efficiency class:

A+

Markenleuchtmittel inkl.
branded lamp incl.

Ø 17 cm, ↑ 37,5 cm, ↳ 22 cm

3-Stufen dimmbar
3-step dimmable

2 Yon / Serie 025
8025.01.70.0000
EAN4003474287676
Silber / Silver

1 x LED / 5,5 W incl.
3000 K / 1 x 420 lm

Energieeffizienzklasse /
energy efficiency class:

A+

Markenleuchtmittel inkl.
branded lamp incl.

Ø 17 cm, ↑ 37,5 cm, ↳ 22 cm

3-Stufen dimmbar
3-step dimmable

3 Yon / Serie 025
8025.01.10.0000
EAN4003474287669
Schwarz / Black

1 x LED / 5,5 W incl.
3000 K / 1 x 420 lm

Energieeffizienzklasse /
energy efficiency class:

A+

Markenleuchtmittel inkl.
branded lamp incl.

Ø 17 cm, ↑ 37,5 cm, ↳ 22 cm

3-Stufen dimmbar
3-step dimmable

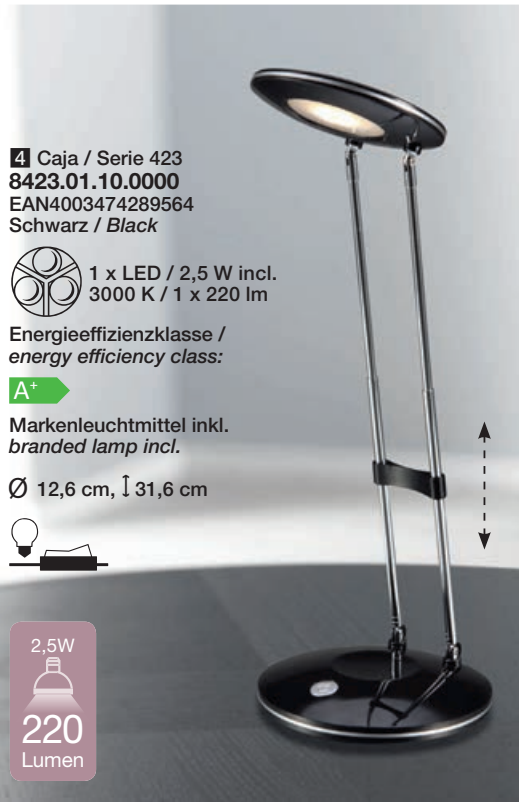

4 Caja / Serie 423
8423.01.10.0000
EAN4003474289564
Schwarz / Black

1 x LED / 2,5 W incl.
3000 K / 1 x 220 lm

Energieeffizienzklasse /
energy efficiency class:

A+

Markenleuchtmittel inkl.
branded lamp incl.

Ø 12,6 cm, ↑ 31,6 cm



2,5W
220
Lumen



5 Caja / Serie 423
8423.01.06.0000
EAN4003474270418
Weiß / White

1 x LED / 2,5 W incl.
3000 K / 1 x 220 lm

Energieeffizienzklasse /
energy efficiency class:

A+

Markenleuchtmittel inkl.
branded lamp incl.

Ø 12,6 cm, ↑ 31,6 cm



6 Fin / Serie 472
8472.01.06.0000
EAN4003474290386
Weiß / White

1 x LED / 2,9 W incl.
5500 K / 1 x 117 lm

Energieeffizienzklasse /
energy efficiency class:

A

Markenleuchtmittel inkl.
branded lamp incl.



2,9W
117
Lumen



↑ 38 cm, ↳ 30 cm

Steckernetzteil mittels USB /
Power supply with USB

Aufladbare Akkubatterie /
Rechargeable battery

Touch Dimmer /
touch dimmer





5W
400
Lumen

14W
1020
Lumen

2 Atkins / Serie 729
3729.01.01.0000
EAN4003474306124
Chrom / Chrome



1 x LED / 14 W incl.
3000 K / 1 x 1020 lm

Energieeffizienzklasse /
energy efficiency class:

A

Markenleuchtmittel inkl. /
branded lamp incl.

Ø 25 cm, ↓ 100 cm

Glas / Glass: 6295,
↑ 65 cm, ↔ 5 cm



1 Atkins / Serie 729
3729.03.01.0000
EAN4003474306131
Chrom / Chrome



3 x LED / 5 W incl.
3000 K / 3 x 400 lm

Energieeffizienzklasse /
energy efficiency class:

A+

Markenleuchtmittel inkl. /
branded lamp incl.

Ø 22 cm, ↓ 143 cm

Glas / Glass: 6293,
↑ 10 cm, ↔ 3,6 cm



Neu!
Neu!



5W
400
Lumen

3 Atkins / Serie 729
8729.01.01.0000
EAN4003474306186
Chrom / Chrome



1 x LED / 5 W incl.
3000 K / 1 x 400 lm

Energieeffizienzklasse /
energy efficiency class:

A+

Markenleuchtmittel inkl. /
branded lamp incl.

Ø 10 cm, ↓ 25 cm

Glas / Glass: 6294
↑ 16 cm, ↔ 3,6 cm



Weitere Leuchten zu
dieser Serie finden Sie
auf Seite 117

You'll find matching
products on page 117



1 Lou / Serie 468
3468.01.32.0000
 EAN4003474285924
 Messing-matt /
 Brass matt finished

 1 x LED / 6 W incl.
 1 x 540 lm

Energieeffizienzklasse /
 energy efficiency class:

A⁺

Markenleuchtmittel inkl. /
 branded lamp incl.

Ø 25 cm, ↑ 138 cm, ⇨ 62 cm

Glas / Glass: 6584, Ø 17 cm



stufenlos dimmbar /
 infinitely dimmable
 Memory Funktion /
 memory function
 inkl. Farbtemperaturwechsler /
 incl. Colour temperature
 changer

2 Lou / Serie 468
3468.01.64.0000
 EAN4003474271798
 Nickel-matt /
 Nickel matt finished

 1 x LED / 6 W incl.
 1 x 540 lm

Energieeffizienzklasse /
 energy efficiency class:

A⁺

Markenleuchtmittel inkl. /
 branded lamp incl.

Ø 25 cm, ↑ 138 cm, ⇨ 62 cm,

Glas / Glass: 6584, Ø 17 cm



stufenlos dimmbar /
 infinitely dimmable
 Memory Funktion /
 memory function
 inkl. Farbtemperaturwechsler /
 incl. Colour temperature
 changer

3 Lou / Serie 468
8468.01.32.0000
 EAN4003474069524
 Messing-matt /
 Brass matt finished

 1 x LED / 6 W incl.
 1 x 540 lm

Energieeffizienzklasse /
 energy efficiency class:

A⁺

Markenleuchtmittel inkl. /
 branded lamp incl.

↑ 50 cm, ⇨ 56 cm,

Glas / Glass: 6584, Ø 17 cm



stufenlos dimmbar / infinitely dimmable
 Memory Funktion / memory function
 inkl. Farbtemperaturwechsler /
 incl. Colour temperature
 changer



4 Lou / Serie 468
8468.01.64.0000
 EAN4003474271804
 Nickel-matt /
 Nickel matt finished

 1 x LED / 6 W incl.
 1 x 540 lm

Energieeffizienzklasse /
 energy efficiency class:

A⁺

Markenleuchtmittel inkl. /
 branded lamp incl.

↑ 50 cm, ⇨ 56 cm,

Glas / Glass: 6584, Ø 17 cm



stufenlos dimmbar /
 infinitely dimmable
 Memory Funktion /
 memory function
 inkl. Farbtemperaturwechsler /
 incl. Colour temperature
 changer



LED Light
 by **WOFI**

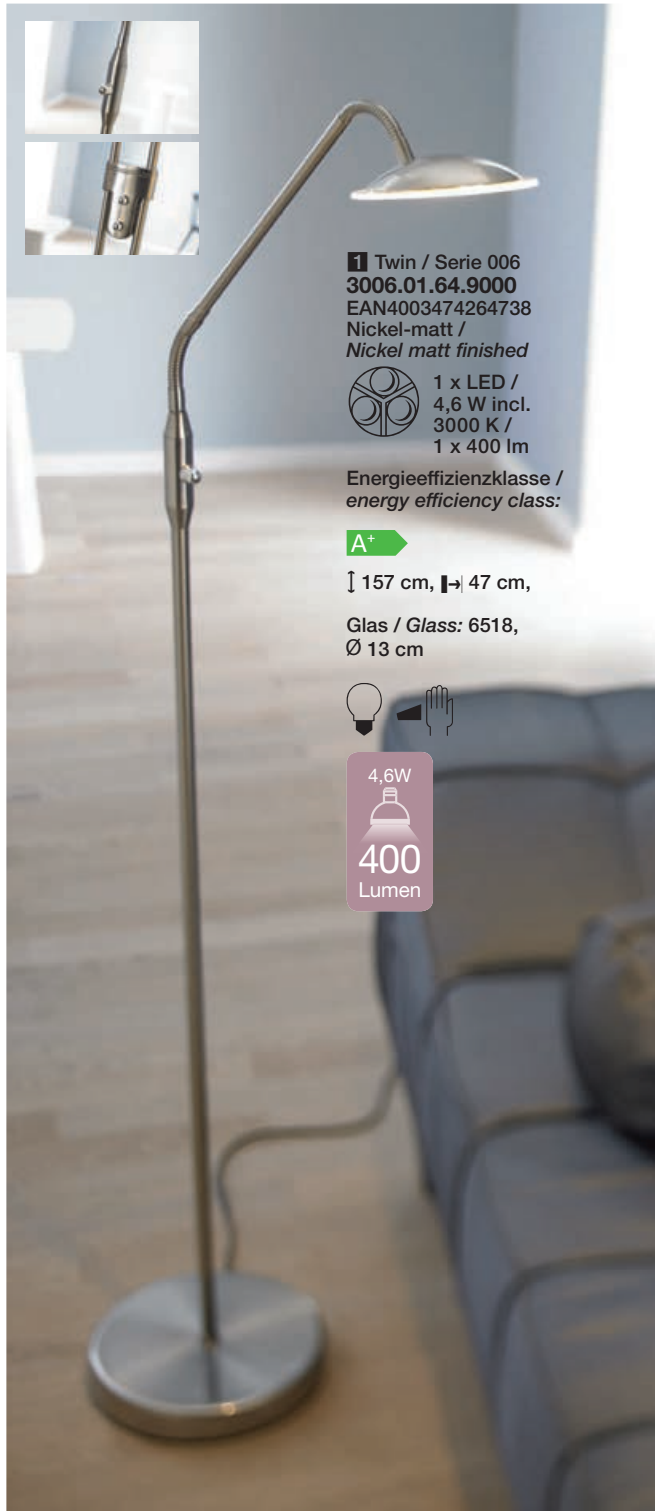

1 Twin / Serie 006
3006.01.64.9000
 EAN4003474264738
 Nickel-matt /
 Nickel matt finished



1 x LED /
 4,6 W incl.
 3000 K /
 1 x 400 lm

Energieeffizienzklasse /
 energy efficiency class:



↑ 157 cm, ↳ 47 cm,

Glas / Glass: 6518,
 Ø 13 cm

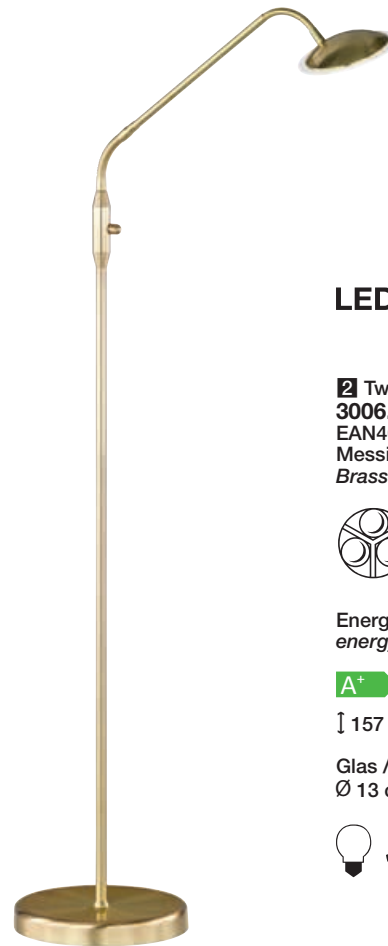

4,6W

400
 Lumen



LED Light
 by **WOFI**

2 Twin / Serie 006
3006.01.32.9000
 EAN4003474261898
 Messing-matt /
 Brass matt finished



1 x LED /
 4,6 W incl.
 3000 K /
 1 x 400 lm

Energieeffizienzklasse /
 energy efficiency class:



↑ 157 cm, ↳ 47 cm,

Glas / Glass: 6518,
 Ø 13 cm



3 Liverpool / Serie 343
8343.01.64.0000
 EAN4003474207490
 Nickel-matt /
 Nickel matt finished



1 x G9 / 48 W incl.
 2800 K / 1 x 740 lm

Energieeffizienzklasse /
 energy efficiency class:



Markenleuchtmittel inkl. /
 branded lamp incl.



↑ 70 cm, ↳ 40 cm

Glas / Glass: 7950, Ø 12,7 cm



48W

740
 Lumen

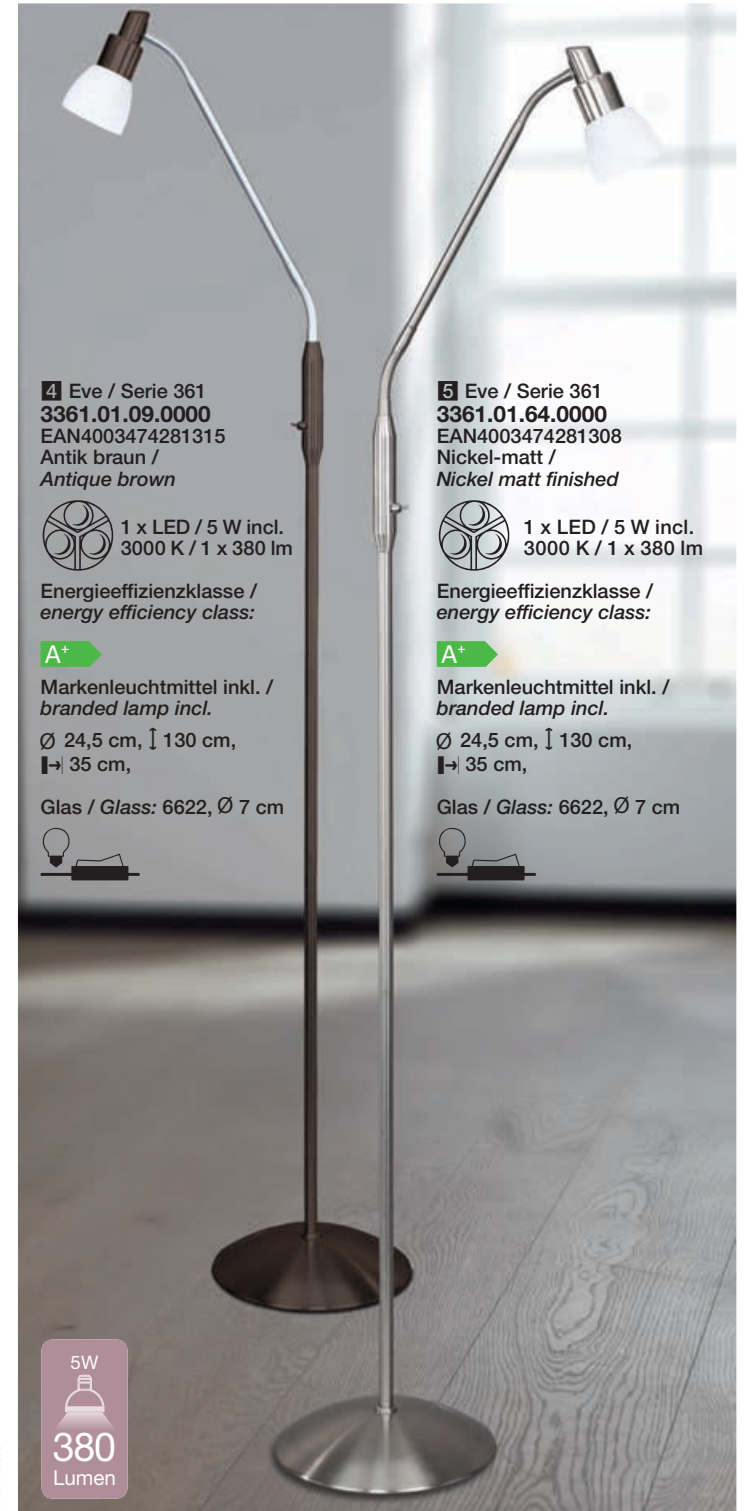

4 Eve / Serie 361
3361.01.09.0000
 EAN4003474281315
 Antik braun /
 Antique brown



1 x LED / 5 W incl.
 3000 K / 1 x 380 lm

Energieeffizienzklasse /
 energy efficiency class:



Markenleuchtmittel inkl. /
 branded lamp incl.

Ø 24,5 cm, ↑ 130 cm,
 ↳ 35 cm,

Glas / Glass: 6622, Ø 7 cm



5W

380
 Lumen

5 Eve / Serie 361
3361.01.64.0000
 EAN4003474281308
 Nickel-matt /
 Nickel matt finished



1 x LED / 5 W incl.
 3000 K / 1 x 380 lm

Energieeffizienzklasse /
 energy efficiency class:



Markenleuchtmittel inkl. /
 branded lamp incl.

Ø 24,5 cm, ↑ 130 cm,
 ↳ 35 cm,

Glas / Glass: 6622, Ø 7 cm



LED Light
by **WOFI**

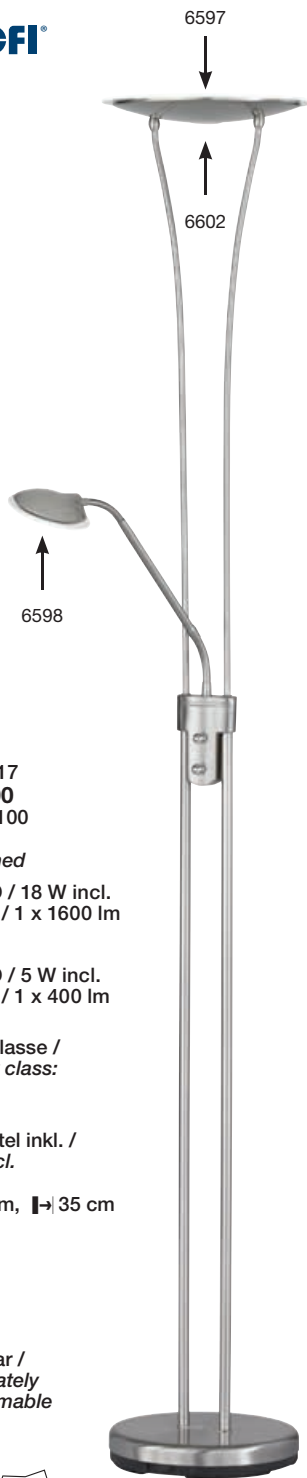

18W
1600
Lumen

5W
400
Lumen

1 Vitro / Serie 317
3317.02.64.0000
EAN4003474281100
Nickel-matt /
Nickel matt finished

1 x LED / 18 W incl.
3000 K / 1 x 1600 lm

1 x LED / 5 W incl.
3000 K / 1 x 400 lm

Energieeffizienzklasse /
energy efficiency class:

A+

Markenleuchtmittel inkl. /
branded lamp incl.

∅ 28 cm, ↑ 180 cm, ⇨ 35 cm

Glas / Glass:

6597, ∅ 28 cm

6598, ∅ 10 cm

6602, ∅ 4,5 cm

getrennt schaltbar /
dimmbar / separately
switchable / dimmable



2 Vant / Serie 807
3807.03.64.0000
EAN4003474281650
Nickel-matt /
Nickel matt finished

1 x LED / 18 W incl.
3000 K / 1 x 1600 lm

1 x LED / 5 W incl.
3000 K / 1 x 400 lm

1 x LED / 3 W incl.
3000 K / 1 x 320 lm

Energieeffizienzklasse /
energy efficiency class:

A+

Markenleuchtmittel inkl. /
branded lamp incl.

↑ 180 cm, ⇨ 36 cm

Glas / Glass:

6599, ∅ 30 cm

6600, ∅ 5,6 cm

6601, ∅ 12 cm

getrennt schaltbar /
dimmbar / separately
switchable / dimmable



18W
1600
Lumen

5W
400
Lumen

3W
320
Lumen

18W
1600
Lumen

4W
400
Lumen



Neu!
Neu!

3 Jay / Serie 658
3658.02.64.0000
EAN4003474295237
Nickel-matt /
Nickel matt finished

1 x LED / 18 W incl.
3000 K / 1 x 1600 lm

1 x LED / 4 W incl.
3000 K / 1 x 400 lm

Energieeffizienzklasse /
energy efficiency class:

A+

Markenleuchtmittel inkl. /
branded lamp incl.

↑ 180 cm, ⇨ 25 cm, ⇨ 39 cm

Glas / Glass:

3043, ⇨ 25 cm

3044, ⇨ 10 cm





1 Skin / Serie 389
3389.02.64.0000
 EAN4003474168265
 Nickel-matt /
 Nickel matt finished

1 x R7S / 230 W incl.
 2950 K / 1 x 5000 lm

Energieeffizienzklasse /
 energy efficiency class:

C

1 x G9 / 33 W incl.
 2700 K / 1 x 460 lm

Energieeffizienzklasse /
 energy efficiency class:

D

Markenleuchtmittel inkl. /
 branded lamp incl.



∓ 180 cm, ⇨ 45 cm

Glas: Alabasterfarbig
 Glass: Alabaster coloured

Glas / Glass:
 7378 / 7353 / 7352 / 7178

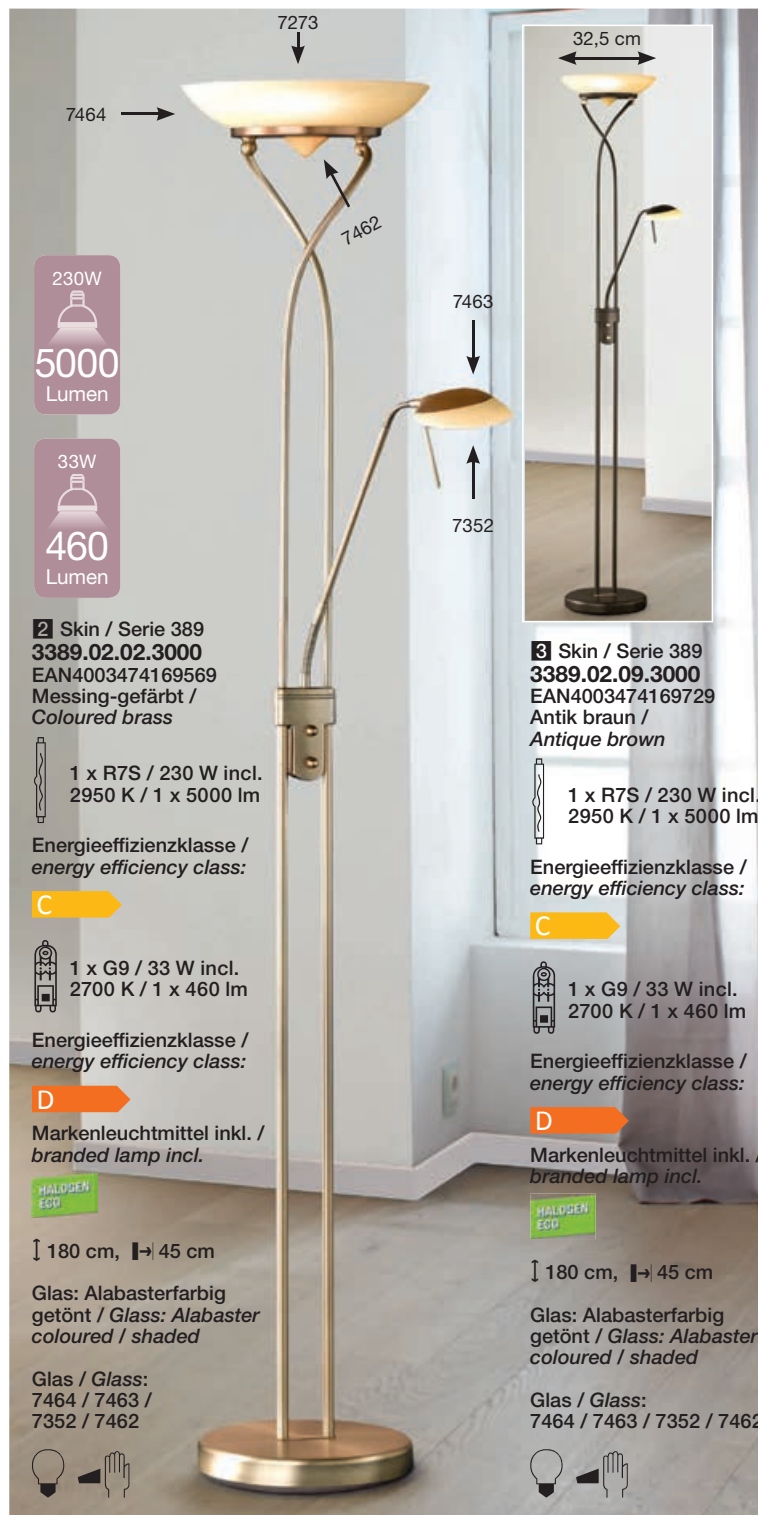

230W

5000
 Lumen

33W

460
 Lumen

2 Skin / Serie 389
3389.02.02.3000
 EAN4003474169569
 Messing-gefärbt /
 Coloured brass

1 x R7S / 230 W incl.
 2950 K / 1 x 5000 lm

Energieeffizienzklasse /
 energy efficiency class:

C

1 x G9 / 33 W incl.
 2700 K / 1 x 460 lm

Energieeffizienzklasse /
 energy efficiency class:

D

Markenleuchtmittel inkl. /
 branded lamp incl.



∓ 180 cm, ⇨ 45 cm

Glas: Alabasterfarbig
 getönt / Glass: Alabaster
 coloured / shaded

Glas / Glass:
 7464 / 7463 /
 7352 / 7462

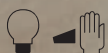

3 Skin / Serie 389
3389.02.09.3000
 EAN4003474169729
 Antik braun /
 Antique brown

1 x R7S / 230 W incl.
 2950 K / 1 x 5000 lm

Energieeffizienzklasse /
 energy efficiency class:

C

1 x G9 / 33 W incl.
 2700 K / 1 x 460 lm

Energieeffizienzklasse /
 energy efficiency class:

D

Markenleuchtmittel inkl. /
 branded lamp incl.



∓ 180 cm, ⇨ 45 cm

Glas: Alabasterfarbig
 getönt / Glass: Alabaster
 coloured / shaded

Glas / Glass:
 7464 / 7463 / 7352 / 7462



Weitere attraktive Stand- und Tischleuchten finden Sie unter der Kategorie „Produktfamilien“ auf folgenden Seiten:
 Additional attractive floor and table lamps please find in the category „product families“ on the following pages:

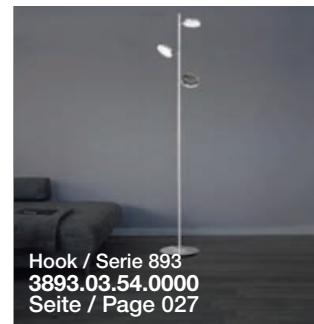

Hook / Serie 893
3893.03.54.0000
 Seite / Page 027

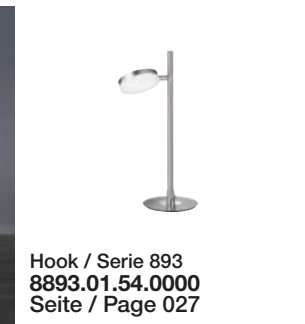

Hook / Serie 893
8893.01.54.0000
 Seite / Page 027



Luz / Serie 682
3682.01.01.0500
 Seite / Page 030



Luz / Serie 682
3682.01.01.0000
 Seite / Page 030 / 031



Luz / Serie 682
8682.01.01.0000
 Seite / Page 030 / 031



Mercur / Serie 313
8313.01.01.0000
 Seite / Page 031

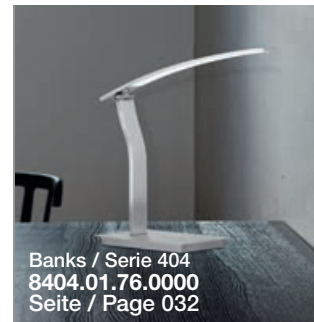

Banks / Serie 404
8404.01.76.0000
 Seite / Page 032



Banks / Serie 404
3404.01.76.0000
 Seite / Page 032

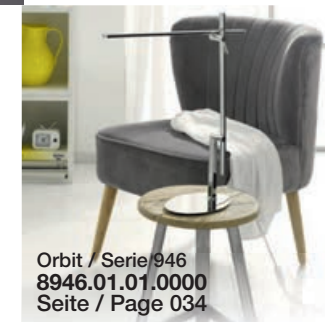

Orbit / Serie 946
8946.01.01.0000
 Seite / Page 034

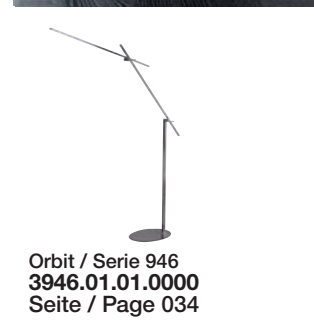

Orbit / Serie 946
3946.01.01.0000
 Seite / Page 034

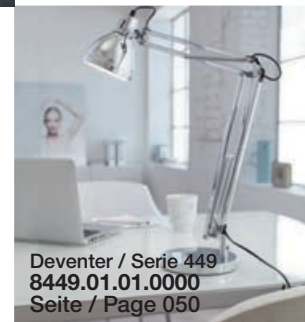

Deventer / Serie 449
8449.01.01.0000
 Seite / Page 050



Deventer / Serie 449
3449.01.01.0000
 Seite / Page 050



Wand- und Deckenleuchten

...Wall and ceiling lights

Leuchten mit Vision

Sie lassen Räume größer wirken oder Flure breiter: Das Licht unserer Wand- und Deckenleuchten beeinflusst die räumliche Wahrnehmung. In moderner, klassischer oder avantgardistischer Ausführung.

Lamps with a vision

They make rooms seem bigger and hallways seem wider: the light from our wall and ceiling lights influences depth perception. Available in modern, classic and avant-garde styles.

Kiana 090	Lilian 098	Jil 106
Ceres 090	Chloe 099	Luv 107
Jaden 091	Midu 100	Kanpur 107
Sila 091	Kent 100	Figgo 107
Liv 092	Delmar 101	Zibo 108
Clay 093	Glam 101	Eddy 108
Soul 094	Atkins 102	Aqaba 108
Estera 095	Everett 102	
Noemi 095	Reims 103	
Surrey 095	Lore 103	
Rondo 096	Bois 104	
Space 096	Dora 104	weitere Wand- und
Modo 097	Mira 104	Deckenleuchten/
Nancy 097	Sphinx 105	additional wall and
Cholet 098	Braez 106	ceiling lamps 109

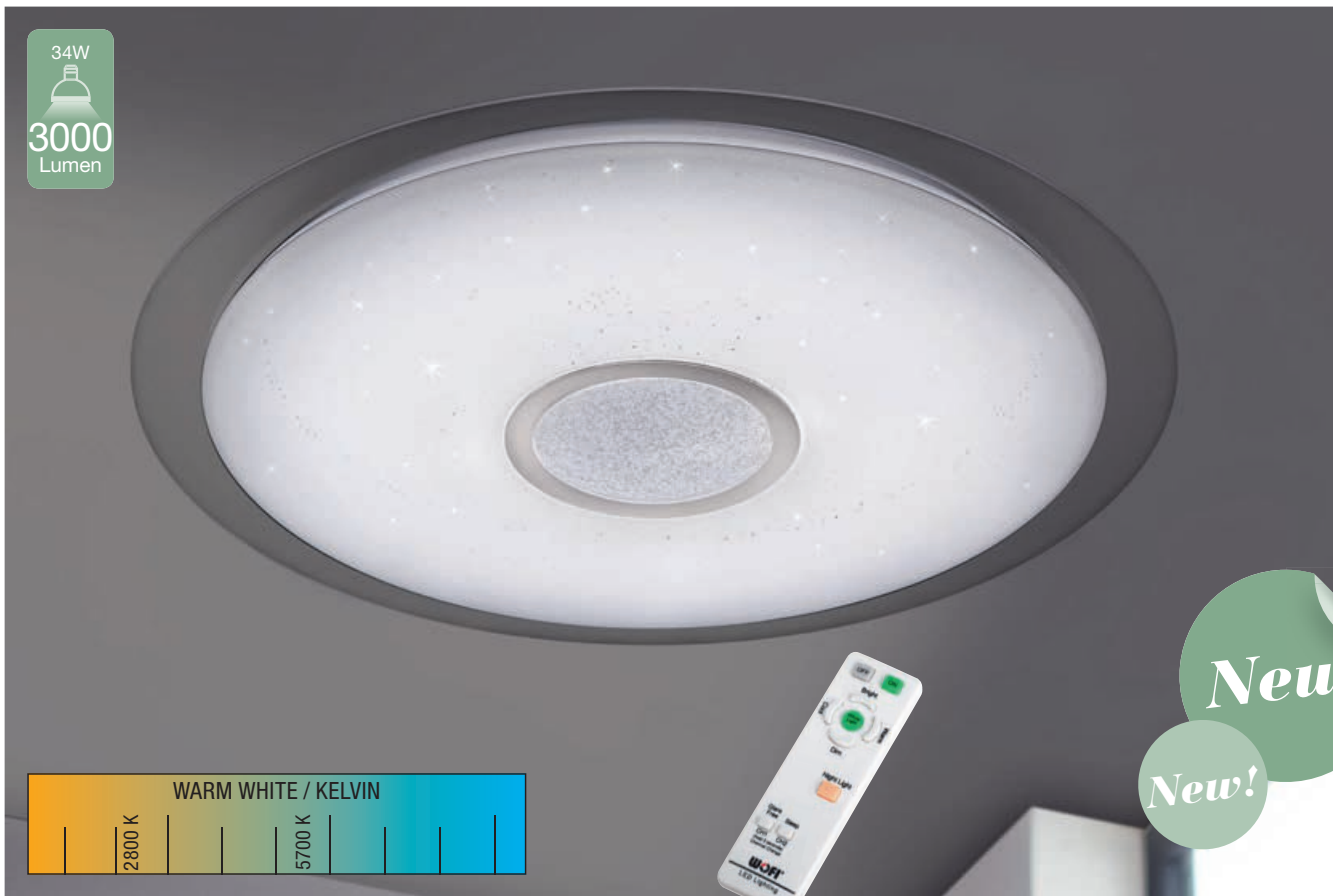

34W
3000
Lumen



Neu!
New!



1 Kiana / Serie 540
9540.01.06.0600
EAN4003474297736
Weiß / White

1 x LED / 34 W incl.
1 x 3000 lm

Energieeffizienzklasse /
energy efficiency class:

A+

Markenleuchtmittel inkl. /
branded lamp incl.

Ø 56,5 cm, H 11 cm



6-Stufen dimmbar
6-step dimmable

inkl. Farbtemperaturwechsler
2800 - 5700 K
incl. colour temperature changer
2800 - 5700 K
inkl. Nachtlicht und Schlafmodus
incl. night light and sleep mode

LED Light
by **WOFI**

**Diese Leuchte
ist besonders gut
gelingen**

Die flache, runde Form lässt KIANA ultramodern wirken. Das weiße Gehäuse verbreitet ein angenehmes Licht. Die Fernbedienung ermöglicht eine Regulierung der Farbtemperatur und der Helligkeit.

**This lamp turned
out especially well**

The flat round shape gives KIANA an ultra modern appearance. Its white case spreads a pleasant, soft light. And the remote control enables you to regulate light and the brightness at the push of a button.

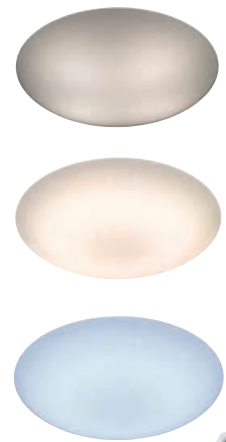

34W
3000
Lumen

2 Ceres / Serie 545
9545.01.06.0000
EAN4003474297866
Weiß / White

1 x LED / 34 W incl.
1 x 3000 lm

Energieeffizienzklasse /
energy efficiency class:

A+

Markenleuchtmittel inkl. /
branded lamp incl.

Ø 53 cm, H 13,5 cm



inkl. Farbtemperaturwechsler
2800 - 5700 K
incl. colour temperature changer
2800 - 5700 K
inkl. Nachtlicht und Schlafmodus
incl. night light and sleep mode

1 Jaden / Serie 662
9662.01.06.0510
 EAN4003474287829
 Weiß / White



1 x LED / 37 W incl.
 1 x 2800 lm

Energieeffizienzklasse /
 energy efficiency class:

A

Markenleuchtmittel inkl. /
 branded lamp incl.

Ø 51 cm, 9 cm



inkl. Farbtemperaturwechsler /
 incl. colour temperature changer
 inkl. Nachtlicht und Schlaf-modus /
 incl. night light and sleep mode



2 Sila / Serie 350
9350.01.64.0000
 EAN4003474263533
 Nickel-matt /
 Nickel matt finished



1 x LED / 72 W incl.
 1 x 5100 lm

Energieeffizienzklasse /
 energy efficiency class:

A

Ø 60 cm, 6 cm



72W
 5100
 Lumen



6000 K



5000 K



4200 K



3000 K



40W
 2500
 Lumen

3 Sila / Serie 350
9350.01.64.0400
 EAN4003474263854
 Nickel-matt /
 Nickel matt finished



1 x LED / 40 W incl.
 1 x 2500 lm

Energieeffizienzklasse /

energy efficiency class:

A

Ø 45 cm, 9,5 cm



inkl. Wechselblende Messing-matt /
 exchangeable cover Brass matt finished

Jede Farbtemperatur ist zusätzlich in 4-Stufen dimmbar
 (25%, 50%, 75%, 100%). Zusatzfunktion: Nachtlicht!

Each color temperature can be additionally dimmed in 4 steps
 (25%, 50%, 75%, 100%). Additional function: nightlight!

LED Light
by **WOFI**

1 Liv / Serie 693
9693.01.70.5200
EAN4003474286235
Silber / Silver

50W
4000 Lumen

1 x LED / 50 W incl.
1 x 4000 lm

Energieeffizienzklasse /
energy efficiency class:
A

Markenleuchtmittel inkl. /
branded lamp incl.

inkl. Farbtemperaturwechsler
stufenlos 2800 - 6800 K /
incl. colour temperature
changer infinitely 2800 - 6800 K

↑ 60 cm, ↔ 120 cm, ↓ 5,5 cm

2 Liv / Serie 693
9693.01.70.1200
EAN4003474265643
Silber / Silver

75W
5600 Lumen

1 x LED / 75 W incl.
3000 K / 1 x 5600 lm

Energieeffizienzklasse /
energy efficiency class:
A

Markenleuchtmittel inkl. /
branded lamp incl.

↑ 60 cm, ↔ 120 cm, ↓ 5,5 cm

Variante ohne Farbtemperatur-
wechsler / Version without colour
temperature changer

↑ 60 cm, ↔ 60 cm, ↓ 5,5 cm

↑ 60 cm, ↔ 120 cm, ↓ 5,5 cm

WARM WHITE / KELVIN

2800 K 6800 K

4 Liv / Serie 693
9693.01.70.5600
EAN4003474286228
Silber / Silver

1 x LED / 44 W incl.
1 x 3400 lm

Energieeffizienzklasse /
energy efficiency class:
A

↑ 60 cm, ↔ 60 cm, ↓ 5,5 cm

inkl. Farbtemperaturwechsler
stufenlos 2800 - 6800 K /
incl. colour temperature
changer infinitely 2800 - 6800 K

Variante ohne Farbtemperatur-
wechsler / Version without
colour temperature changer

5 Liv / Serie 693
9693.01.70.0600
EAN4003474265636
Silber / Silver

1 x LED / 64 W incl.
3000 K / 1 x 4630 lm

Energieeffizienzklasse /
energy efficiency class:
A

↑ 60 cm, ↔ 60 cm, ↓ 5,5 cm

3 Liv / Serie 693
9693.01.70.9000
EAN4003474300177
Silber / Silver

42W
3200 Lumen

1 x LED / 42 W incl.
1 x 3200 lm

Energieeffizienzklasse /
energy efficiency class:
A

Markenleuchtmittel inkl. /
branded lamp incl.

↑ 30 cm, ↔ 120 cm, ↓ 5,5 cm

Farbtemperaturwechsler
2800K-6800K /
Colour temperature changer
2800K-6800K

↑ 30 cm, ↔ 120 cm, ↓ 5,5 cm

Neu!
New!

LED Light
by **WOFI**

6 Liv / Serie 693
9693.01.70.5300
EAN4003474286211
Silber / Silver

31W
2070 Lumen

1 x LED / 24 W incl.
1 x 1500 lm

Energieeffizienzklasse /
energy efficiency class:
A

↑ 30 cm, ↔ 30 cm, ↓ 5,5 cm

inkl. Farbtemperaturwechsler
stufenlos 2800 - 6800 K /
incl. colour temperature
changer infinitely 2800 - 6800 K

Variante ohne Farbtemperatur-
wechsler / Version without
colour temperature changer

7 Liv / Serie 693
9693.01.70.0300
EAN4003474265629
Silber / Silver

1 x LED / 31 W incl.
3000 K / 1 x 2070 lm

Energieeffizienzklasse /
energy efficiency class:
A

↑ 30 cm, ↔ 30 cm, ↓ 5,5 cm

64W
4630 Lumen

44W
3400 Lumen

LED Light
by WOFI®

10W
820
Lumen

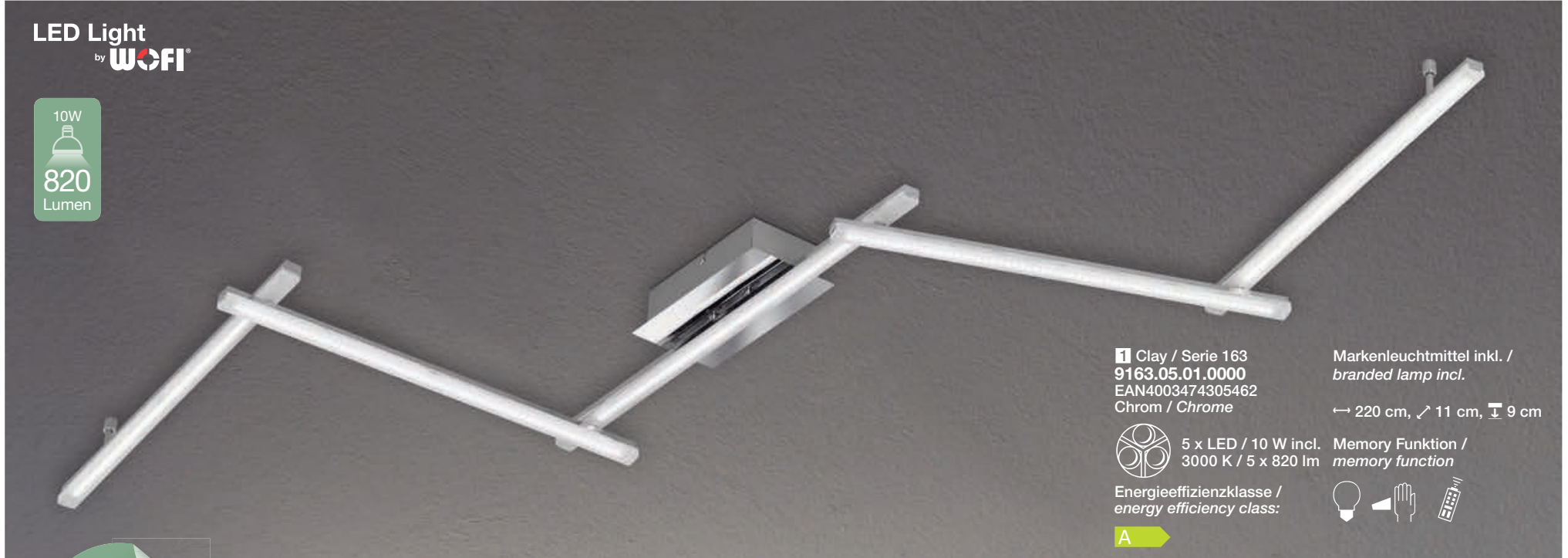

1 Clay / Serie 163
9163.05.01.0000
EAN4003474305462
Chrom / Chrome

Markenleuchtmittel inkl. /
branded lamp incl.

↔ 220 cm, ↗ 11 cm, ⊥ 9 cm



5 x LED / 10 W incl.
3000 K / 5 x 820 lm

Memory Funktion /
memory function

Energieeffizienzklasse /
energy efficiency class:

A



Neu!
New!

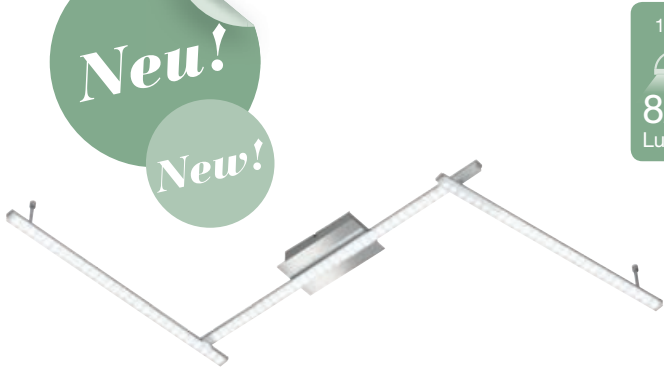

10W
820
Lumen

2 Clay / Serie 163
9163.03.01.0000
EAN4003474299938
Chrom / Chrome

Energieeffizienzklasse /
energy efficiency class:

A

Markenleuchtmittel inkl. /
branded lamp incl.

↔ 180 cm, ↗ 11 cm, ⊥ 9 cm



3 x LED / 10 W incl.
3000 K / 3 x 820 lm



20W
1640
Lumen

3 Clay / Serie 163
9163.01.01.1000
EAN4003474306285
Chrom / Chrome

Energieeffizienzklasse /
energy efficiency class:

A

Markenleuchtmittel inkl. /
branded lamp incl.

↔ 120 cm, ↗ 11 cm, ⊥ 9 cm



1 x LED / 20 W incl.
3000 K / 1 x 1640 lm



10W
820
Lumen

4 Clay / Serie 163
9163.02.01.0000
EAN4003474301402
Chrom / Chrome

Energieeffizienzklasse /
energy efficiency class:

A

Markenleuchtmittel inkl. /
branded lamp incl.

↔ 125 cm, ↗ 11 cm, ⊥ 9 cm



2 x LED / 10 W incl.
3000 K / 2 x 820 lm



1 Soul / Serie 117
9117.01.54.0000
 EAN4003474291031
 Nickel-matt / Chrom /
 Nickel matt finished / Chrome



1 x LED / 44 W incl.
 3000 K / 1 x 3000 lm

Energieeffizienzklasse /
 energy efficiency class:

A

↔ 61 cm, ↗ 55 cm,
 ↓ 6,5 cm

Dimmbar mittels geeignetem
 Wanddimmer /
 dimmable by suitable wall
 dimmer



Ein Allround-Talent mit
 innovativer Technologie

An allrounder with
 innovative technology

LED Light
 by **WOFI**



2 Soul / Serie 117
9117.01.54.0CLC
 EAN4003474305882
 Nickel-matt / Chrom /
 Nickel matt finished / Chrome



1 x LED / 44 W incl.
 3000 K / 1 x 3000 lm

Energieeffizienzklasse /
 energy efficiency class:

A

↔ 61 cm, ↗ 55 cm, ↓ 6,5 cm

per App steuerbar /
 operable by App



clc

collective
 light
 control
 powered by
 HomeMatic

Licht in Balance: flache Optik – runder Gesamteindruck

...Balanced lighting: a flat look for
 a well-rounded impression

Neu!

New!



LED Light
by **WOFI**



1 Estera / Serie 093
9093.06.01.0000
EAN4003474301600
Chrom / Chrome

Energieeffizienzklasse /
energy efficiency class:
A+

Markenleuchtmittel inkl. /
branded lamp incl.

6 x LED / 5 W incl.
3000 K / 6 x 400 lm

↑ 35 cm, ↔ 35 cm, ⊥ 9,5 cm
Glas / Glass: 6118, ↔ 9 cm



2 Estera / Serie 093
4093.01.01.0000
EAN4003474301341
Chrom / Chrome

5W
400 Lumen

Markenleuchtmittel inkl. /
branded lamp incl.

↑ 16 cm, ↳ 8,5 cm, ↗ 5,5 cm,
Glas / Glass: 6118, ↔ 9 cm

1 x LED / 5 W incl.
3000 K / 1 x 400 lm

Energieeffizienzklasse /
energy efficiency class:
A+



3 Estera / Serie 093
7093.02.01.0000
EAN4003474301358
Chrom / Chrome

Energieeffizienzklasse /
energy efficiency class:
A+

Markenleuchtmittel inkl. /
branded lamp incl.

2 x LED / 5 W incl.
3000 K / 2 x 400 lm

↔ 34 cm, ↗ 7 cm, ⊥ 9,5 cm
Glas / Glass: 6118, ↔ 9 cm

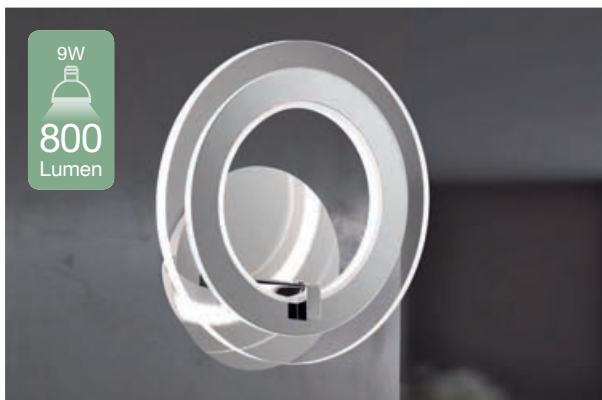

4 Noemi / Serie 146
4146.01.01.0000
EAN4003474304717
Chrom / Chrome

9W
800 Lumen

Markenleuchtmittel inkl. /
branded lamp incl.

Ø 23 cm, ↗ 11 cm, ↳ 12 cm,

1 x LED / 9 W incl.
3000 K / 1 x 800 lm

Energieeffizienzklasse /
energy efficiency class:
A+



5 Surrey / Serie 815
9815.04.54.0000
EAN4003474301761
Nickel-matt / Chrom /
Nickel matt finished / Chrome

6W
410 Lumen

9W
540 Lumen

Markenleuchtmittel inkl. /
branded lamp incl.

↔ 62 cm, ↗ 42 cm,
⊥ 14 cm,

2 x LED / 9 W incl.
3000 K / 2 x 540 lm

2 x LED / 6 W incl.
3000 K / 2 x 410 lm

Dimmbar mittels geeignetem
Wanddimmer / dimmable by
suitable wall dimmer

Energieeffizienzklasse /
energy efficiency class:
A



6 Noemi / Serie 146
9146.03.01.0000
EAN4003474304823
Chrom / Chrome

9W
800 Lumen

Energieeffizienzklasse /
energy efficiency class:
A+

Markenleuchtmittel inkl. /
branded lamp incl.

3 x LED / 9 W incl.
3000 K / 3 x 800 lm

Ø 55 cm, ⊥ 11,5 cm

LED Light
by WOFI®

13W
750
Lumen



1 Rondo / Serie 671
9671.01.06.0000
EAN4003474287102
Weiß / White

Energieeffizienzklasse /
energy efficiency class:

A

Markenleuchtmittel inkl. /
branded lamp incl.



1 x LED / 13 W incl.
3000 K / 1 x 750 lm

∅ 30 cm, ↓ 6 cm



2 Rondo / Serie 671
9671.01.06.0500
EAN4003474287119
Weiß / White

Energieeffizienzklasse /
energy efficiency class:

A

Markenleuchtmittel inkl. /
branded lamp incl.



1 x LED / 19 W incl.
3000 K / 1 x 1170 lm

∅ 50 cm, ↓ 6 cm

19W
1170
Lumen



3 Space / Serie 216
4216.01.01.0000
EAN4003474110004
Chrom / Chrome

Energieeffizienzklasse /
energy efficiency class:

A+

Markenleuchtmittel inkl. /
branded lamp incl.



1 x LED / 6 W incl.
3000 K / 1 x 550 lm

↑ 14 cm, ↔ 14 cm, ↓ 6 cm



4 Space / Serie 216
9216.04.01.0000
EAN4003474289793
Chrom / Chrome

Markenleuchtmittel inkl. /
branded lamp incl.

↑ 30 cm, ↔ 30 cm, ↓ 7,5 cm



4 x LED / 6 W incl.
3000 K / 4 x 550 lm

Dimmbar mittels geeignetem
Wanddimmer /
dimmable by suitable wall
dimmer

Energieeffizienzklasse /
energy efficiency class:

A+



5 Space / Serie 216
7216.02.01.0000
EAN4003474289762
Chrom / Chrome

Energieeffizienzklasse /
energy efficiency class:

A+

Markenleuchtmittel inkl. /
branded lamp incl.



2 x LED / 6 W incl.
3000 K / 2 x 550 lm

↑ 14 cm, ↔ 30 cm, ↓ 6 cm



6W
550
Lumen



6 Space / Serie 216
7216.04.01.0000
EAN4003474289786
Chrom / Chrome

Energieeffizienzklasse /
energy efficiency class:

A+

Markenleuchtmittel inkl. /
branded lamp incl.



4 x LED / 6 W incl.
3000 K / 4 x 550 lm

↑ 15 cm, ↔ 61,5 cm, ↓ 9 cm

Dimmbar mittels geeignetem
Wanddimmer /
dimmable by suitable wall dimmer





1 Modo / Serie 547
9547.01.64.0400
 EAN4003474284415
 Nickel-matt / Nickel matt finished

Markenleuchtmittel inkl. branded lamp incl.
 Ø 50 cm, 13,5 cm

1 x LED / 27 W incl. 3000 K / 1 x 2160 lm
 Glas / Glass: 1424

Dimmbar mittels geeignetem Wanddimmer / dimmable by suitable wall dimmer

Energieeffizienzklasse / energy efficiency class: **A**

LED Light
 by **WOFI**



3 Nancy / Serie 276
9276.01.01.0200
 EAN4003474280820
 Chrom / Chrome

Markenleuchtmittel inkl. branded lamp incl.
 Ø 20 cm, 7,2 cm



1 x LED / 7,5 W incl. 3000 K / 1 x 650 lm

Glas / Glass: 6589, Ø 20 cm
 6590, Ø 15 cm

Energieeffizienzklasse / energy efficiency class:



7,5W

650
 Lumen



5 Nancy / Serie 276
9276.01.01.1300
 EAN4003474280943
 Chrom / Chrome

Markenleuchtmittel inkl. branded lamp incl.
 28 cm, 28 cm, 7,2 cm

1 x LED / 17,5 W incl. 3000 K / 1 x 1550 lm
 Glas / Glass: 6595, 28 x 28 cm
 6596, 22 x 22 cm

Energieeffizienzklasse / energy efficiency class:

A+



2 Modo / Serie 547
9547.01.64.0300
 EAN4003474284408
 Nickel-matt / Nickel matt finished

Markenleuchtmittel inkl. branded lamp incl.
 Ø 38 cm, 12 cm

1 x LED / 18 W incl. 3000 K / 1 x 1440 lm
 Glas / Glass: 1423

Energieeffizienzklasse / energy efficiency class: **A**



4 Nancy / Serie 276
9276.01.01.0300
 EAN4003474280844
 Chrom / Chrome

Markenleuchtmittel inkl. branded lamp incl.
 Ø 30 cm, 7,2 cm

1 x LED / 17,5 W incl. 3000 K / 1 x 1550 lm
 Glas / Glass: 6591, Ø 30 cm
 6592, Ø 24 cm

Energieeffizienzklasse / energy efficiency class:

A+

Leuchten für Generationen

Zukunftsweisende Technologie verknüpft mit schlichter und klassischer Eleganz.

Lighting for generations

Cutting edge technology combined with simple and classic elegance.

6 Nancy / Serie 276
9276.01.01.1200
 EAN4003474280929
 Chrom / Chrome



1 x LED / 7,5 W incl. 3000 K / 1 x 650 lm

Energieeffizienzklasse / energy efficiency class:



Markenleuchtmittel inkl. branded lamp incl.

18 cm, 18 cm, 7,2 cm

Glas / Glass: 6593, 18 x 18 cm
 6594, 13 x 13 cm

7,5W

650
 Lumen

LED Light
by **WOFI**



5W
300
Lumen

4,5W
300
Lumen

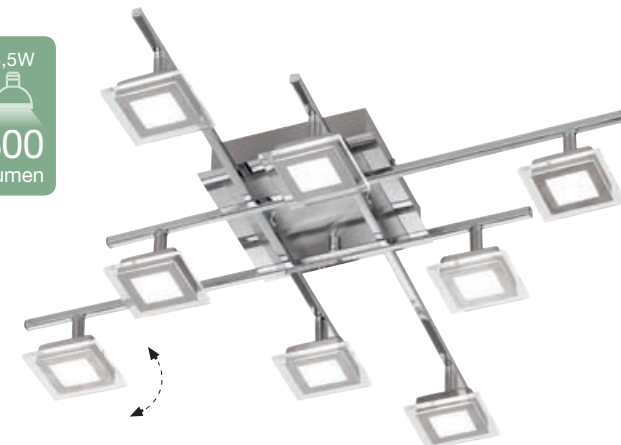

3 Lilian / Serie 244
9244.08.54.0000
EAN4003474304830
Nickel-matt / Chrom /
Nickel matt finished / Chrome

 8 x LED / 4,5 W incl.
3000 K / 8 x 300 lm

Energieeffizienzklasse /
energy efficiency class:

A+

Markenleuchtmittel inkl. /
branded lamp incl.

↔ 66 cm, ↓ 66 cm, ⊥ 14 cm

New!

New!

1 Cholet / Serie 197
9197.09.64.0000
EAN4003474281155
Nickel-matt /
Nickel matt finished

 9 x LED / 5 W incl.
3000 K / 9 x 300 lm

Energieeffizienzklasse /
energy efficiency class:

A

Markenleuchtmittel inkl. /
branded lamp incl.

↓ 35 cm, ↔ 35 cm, ⊥ 11,5 cm

Glas / Glass: 6503,
↓ 8 cm, ↔ 8 cm



2 Cholet / Serie 197
9197.05.64.0000
EAN4003474281148
Nickel-matt /
Nickel matt finished

 5 x LED / 5 W incl.
3000 K / 5 x 300 lm

Energieeffizienzklasse /
energy efficiency class:

A

Markenleuchtmittel inkl. /
branded lamp incl.

↓ 28 cm, ↔ 28 cm, ⊥ 11,5 cm

Glas / Glass: 6503,
↓ 8 cm, ↔ 8 cm





4,5W
300
Lumen

1 Chloe / Serie 195
9195.08.01.0000
EAN4003474304786
Chrom / Chrome

8 x LED / 4,5 W incl.
3000 K / 8 x 300 lm

Energieeffizienzklasse /

energy efficiency class:

A

Markenleuchtmittel inkl. /
branded lamp incl.

↔ 66 cm, ↗ 66 cm, ⊥ 14 cm

Neu!

Neu!



4,5W
300
Lumen

2 Chloe / Serie 195
9195.05.01.0000
EAN4003474303963
Chrom / Chrome

5 x LED / 4,5 W incl.
3000 K / 5 x 300 lm

Energieeffizienzklasse /
energy efficiency class:

A

Markenleuchtmittel inkl. /
branded lamp incl.

⊥ 35,5 cm, ↔ 53 cm, ↗ 53 cm

5W
300
Lumen



3 Chloe / Serie 195
9195.06.01.0000
EAN4003474281599
Chrom / Chrome

6 x LED / 5 W incl.
3000 K / 6 x 300 lm

Energieeffizienzklasse /
energy efficiency class:

A

Markenleuchtmittel inkl. /
branded lamp incl.

Ø 35 cm, ⊥ 10 cm



4 Chloe / Serie 195
9195.04.01.0000
EAN4003474283746
Chrom / Chrome

4 x LED / 5 W incl.
3000 K / 4 x 300 lm

Energieeffizienzklasse /
energy efficiency class:

A

Markenleuchtmittel inkl. /
branded lamp incl.

Ø 30 cm, ⊥ 10 cm



1 Midu / Serie 193
9193.03.01.0000
 EAN4003474280738
 Chrom / Chrome

 3 x LED / 5 W incl.
 3000 K / 3 x 430 lm

Energieeffizienzklasse /
 energy efficiency class:

A⁺

Markenleuchtmittel inkl. /
 branded lamp incl.

Ø 43,5 cm, \downarrow 14,6 cm,

Glas / Glass: 6609,
 Ø 3,5 cm, \downarrow 8 cm

2 Midu / Serie 193
9193.06.01.0000
 EAN4003474281124
 Chrom / Chrome

 6 x LED / 5 W incl.
 3000 K / 6 x 430 lm

Energieeffizienzklasse /
 energy efficiency class:

A⁺

Markenleuchtmittel inkl. /
 branded lamp incl.

Ø 45,6 cm, \downarrow 14,5 cm,

Glas / Glass: 6609,
 Ø 3,5 cm, \downarrow 8 cm

5W

430
 Lumen



LED Light
 by **WOFI**

4 Kent / Serie 060
9060.06.01.0000
 EAN4003474283272
 Chrom / Chrome

 6 x LED / 5 W incl.
 3000 K / 6 x 380 lm

Energieeffizienzklasse /
 energy efficiency class:

A⁺

Markenleuchtmittel inkl. /
 branded lamp incl.

Ø 25 cm, \downarrow 16 cm,

Glas / Glass: 1406,
 Ø 4 cm, \downarrow 9 cm

5W

380
 Lumen

3 Midu / Serie 193
4193.01.01.0000
 EAN4003474280714
 Chrom / Chrome

 1 x LED / 5 W incl.
 3000 K / 1 x 430 lm

Energieeffizienzklasse /
 energy efficiency class:

A⁺

Markenleuchtmittel inkl. /
 branded lamp incl.

\downarrow 23 cm, \leftrightarrow 8,5 cm, \rightarrow 14 cm,

Glas / Glass: 6609,
 Ø 3,5 cm, \downarrow 8 cm



5W

430
 Lumen

1 Glam/ Serie 445
9445.04.01.0000
 EAN4003474293103
 Chrom / Chrome



4 x LED / 4,5 W incl.
 3000 K / 4 x 320 lm

Energieeffizienzklasse /
 energy efficiency class:

A+

Markenleuchtmittel inkl. /
 branded lamp incl.

Ø 30 cm, ↓ 17 cm

Glas / Glass:
 3022, Ø 3,9 cm, ↓ 23 cm
 3049, Ø 3,9 cm, ↓ 16,5 cm
 3050, Ø 3,9 cm, ↓ 13 cm



4,5W

320
 Lumen

2 Glam/ Serie 445
9445.05.01.0000
 EAN4003474293165
 Chrom / Chrome

Energieeffizienzklasse /
 energy efficiency class:

A+

Markenleuchtmittel inkl. /
 branded lamp incl.

Ø 40 cm, ↓ 17 cm

Glas / Glass:
 3022, Ø 3,9 cm, ↓ 23 cm
 3049, Ø 3,9 cm, ↓ 16,5 cm
 3050, Ø 3,9 cm, ↓ 13 cm

4,5W

320
 Lumen

LED Light
 by **WOFI**

3 Delmar / Serie 674
9674.16.01.0000
 EAN4003474302553
 Chrom / Chrome

16 x LED / 2 W incl.
 3000 K / 16 x 160 lm

Energieeffizienzklasse /
 energy efficiency class:

A+

Markenleuchtmittel inkl. /
 branded lamp incl.

↓ 64 cm, ↔ 60,5 cm, ↓ 18,5 cm,
 Glas / Glass: 1162

4,5W

320
 Lumen

Neu!

4 Delmar / Serie 674
9674.12.01.0000
 EAN4003474300412
 Chrom / Chrome

12 x LED / 2 W incl.
 3000 K / 12 x 160 lm

Energieeffizienzklasse /
 energy efficiency class:

A

Markenleuchtmittel inkl. /
 branded lamp incl.

↓ 40 cm, ↔ 40 cm, ↓ 16 cm
 Glas / Glass: 1162

5 Delmar / Serie 674
4674.04.01.0000
 EAN4003474302386
 Chrom / Chrome

4 x LED / 2 W incl.
 3000 K / 4 x 160 lm

Energieeffizienzklasse /
 energy efficiency class:

A+

Markenleuchtmittel inkl. /
 branded lamp incl.

↓ 30 cm, ↔ 30 cm, ↗ 10 cm,
 Glas / Glass: 1162

Neu!



1 Everett / Serie 067
9067.08.64.0000
 EAN4003474291024
 Nickel-matt /
 Nickel matt finished

 8 x LED / 3 W incl.
 3000 K / 8 x 270 lm

Energieeffizienzklasse /
 energy efficiency class:
A+

Markenleuchtmittel inkl. /
 branded lamp incl.

↓ 66,5 cm, ↔ 66,5 cm,
 ↓ 10,5 cm

Glas / Glass: 8023,
 Ø 10,5 cm

3W

270
 Lumen

3 Atkins / Serie 729
9729.06.01.0500
 EAN4003474306278
 Chrom / Chrome

 6 x LED / 5 W incl.
 3000 K / 6 x 400 lm

Energieeffizienzklasse /
 energy efficiency class:
A+

Markenleuchtmittel inkl.
 branded lamp incl.

Ø 45,5 cm, ↓ 15 cm

Glas / Glass: 6293
 ↓ 10 cm, ↔ 3,6 cm



LED Light
 by **WOFI**



2 Everett / Serie 067
9067.06.64.0000
 EAN4003474291000
 Nickel-matt /
 Nickel matt finished

 6 x LED / 3 W incl.
 3000 K / 6 x 270 lm

3W

270
 Lumen

Energieeffizienzklasse /
 energy efficiency class:
A+

Markenleuchtmittel inkl. /
 branded lamp incl.

↓ 57 cm, ↔ 57 cm,
 ↓ 10 cm

Glas / Glass: 8023,
 Ø 10,5 cm

New!



4 Atkins / Serie 729
9729.03.01.0000
 EAN4003474306261
 Chrom / Chrome

 3 x LED / 5 W incl.
 3000 K / 3 x 400 lm

Energieeffizienzklasse /
 energy efficiency class:
A+

Markenleuchtmittel inkl.
 branded lamp incl.

Ø 44 cm, ↓ 15 cm

Glas / Glass: 6293
 ↓ 10 cm, ↔ 3,6 cm

5W

400
 Lumen

LED Light
by **WOFI**



1 Reims / Serie 272
9272.09.01.0000
EAN4003474281971
Chrom / Chrome

9 x LED / 3 W incl.
3000 K / 9 x 200 lm

Energieeffizienzklasse /
energy efficiency class:
A+

Markenleuchtmittel inkl. /
branded lamp incl.

∟ 40 cm, ↔ 40 cm, ⊥ 8 cm,
Glas / Glass: 6577, ∟ 36 cm, ↔ 36 cm

3W
200
Lumen

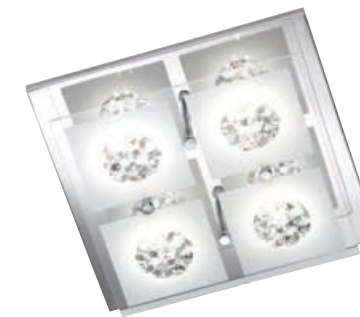

2 Reims / Serie 272
9272.04.01.0000
EAN4003474281964
Chrom / Chrome

4 x LED / 3 W incl.
3000 K / 4 x 200 lm

Energieeffizienzklasse /
energy efficiency class:
A+

Markenleuchtmittel inkl. /
branded lamp incl.

∟ 25 cm, ↔ 25 cm, ⊥ 8 cm,
Glas / Glass: 6576, ∟ 22 cm, ↔ 22 cm

5 Lore / Serie 624
9624.05.01.0320
EAN4003474290379
Chrom / Chrome

5 x LED / 3 W incl.
3000 K / 5 x 260 lm

Energieeffizienzklasse /
energy efficiency class:

A+

Markenleuchtmittel inkl. /
branded lamp incl.

∅ 32 cm, ⊥ 9 cm,

Glas / Glass: 3002, ∅ 30 cm



3W
260
Lumen

Kristallene Lichtspiele

...Light effects filled with magic

3 Reims / Serie 272
4272.01.01.0000
EAN4003474303741
Chrom / Chrome

1 x LED / 4 W incl.
3000 K / 1 x 320 lm

Energieeffizienzklasse /
energy efficiency class:

A+

Markenleuchtmittel inkl. /
branded lamp incl.

∟ 12 cm, ↔ 12 cm, ⇨ 7 cm

Glas / Glass: 1152



4W
320
Lumen

Neu!
New!

4 Reims / Serie 272
4272.02.01.0000
EAN4003474303758
Chrom / Chrome

2 x LED / 4 W incl.
3000 K / 2 x 320 lm

Energieeffizienzklasse /
energy efficiency class:

A+

Markenleuchtmittel inkl. /
branded lamp incl.

∟ 12 cm, ↔ 24 cm, ⇨ 7 cm

Glas / Glass: 1154



3W
280
Lumen

1 Bois / Serie 854
9854.04.01.0000
EAN4003474282626
Chrom / Chrome

 4 x LED / 3 W incl.
3000 K / 4 x 280 lm

Energieeffizienzklasse /
energy efficiency class:

A+

Markenleuchtmittel inkl. /
branded lamp incl.

↓ 25 cm, ↔ 25 cm, ⊥ 9 cm

Glas / Glass: 1163



5,2W
400
Lumen

2 Dora / Serie 278
9278.04.01.0000
EAN4003474305325
Chrom / Chrome

 4 x LED / 5,2 W incl.
3000 K / 4 x 400 lm

Energieeffizienzklasse /
energy efficiency class:

A

Markenleuchtmittel inkl. /
branded lamp incl.

↓ 30 cm, ↔ 30 cm, ⊥ 11 cm

Glas / Glass: 3066



Neu!

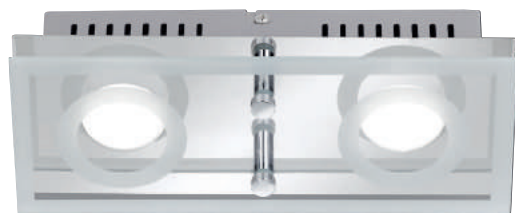

4 Mira / Serie 475
9475.04.01.0000
EAN4003474277738
Chrom / Chrome

 4 x LED / 4 W incl.
3000 K / 4 x 300 lm

Energieeffizienzklasse /
energy efficiency class:

A+

Markenleuchtmittel inkl. /
branded lamp incl.

↓ 25 cm, ↔ 25 cm, ⊥ 7 cm,

Glas / Glass: 6562

3 Mira / Serie 475
7475.02.01.0000
EAN4003474277721
Chrom / Chrome

 2 x LED / 4 W incl.
3000 K / 2 x 300 lm

Energieeffizienzklasse /
energy efficiency class:

A+

Markenleuchtmittel inkl. /
branded lamp incl.

↔ 25 cm, ↓ 10 cm, ⊥ 7 cm

Glas / Glass: 6561



4W
300
Lumen

5 Mira / Serie 475
4475.01.01.0000
EAN4003474277714
Chrom / Chrome

 1 x LED / 4 W incl.
3000 K / 1 x 300 lm

Energieeffizienzklasse /
energy efficiency class:

A+

Markenleuchtmittel inkl. /
branded lamp incl.

↔ 15 cm, ↓ 15 cm, ⊥ 6 cm

Glas / Glass: 6560



LED Light
by **WOLFF**



1 Sphinx / Serie 102
9102.05.01.0000
EAN4003474280691
Chrom / Chrome

 5 x LED / 5 W incl.
3000 K / 5 x 420 lm

Energieeffizienzklasse /
energy efficiency class:

A+

Markenleuchtmittel inkl. /
branded lamp incl.

↓ 30 cm, ↔ 30 cm, ⊥ 7,5 cm,

Glas / Glass: 6300,
↔ 30 cm, ↓ 30 cm



Modernes Design, verbunden mit innovativer
LED-Technologie – die Deckenleuchten der
Serie SPHINX.

Modern design, combined with modern LED
technology: that's the essence of the SPHINX
series.

2 Sphinx / Serie 102
9102.09.01.0000
EAN4003474283876
Chrom / Chrome

 9 x LED / 5 W incl.
3000 K / 9 x 420 lm

Energieeffizienzklasse /
energy efficiency class:

A+

Markenleuchtmittel inkl. /
branded lamp incl.

↓ 39 cm, ↔ 39 cm, ⊥ 7,5 cm

Glas / Glass: 6301,
↔ 39 cm, ↓ 39 cm



**LED-Technologie
im Quadrat**
... LED technology, squared



33W
460
Lumen

1 Braez / Serie 581
4581.02.06.0000
EAN4003474259376
Weiß / White

 2 x G9 / 33 W incl.
2700 K / 2 x 460 lm

Energieeffizienzklasse /
energy efficiency class:
D

Markenleuchtmittel inkl.
branded lamp incl.



↑ 22 cm, ↔ 7,5 cm, ⇨ 7,5 cm

LED Light
by **WOFI**

Neu!
New!



3 Jil / Serie 835
4835.01.54.1000
4003474305974
Nickel-matt / Chrom /
Nickel matt finished / Chrome

 1 x LED / 16 W incl.
3000 K / 1 x 1400 lm

Energieeffizienzklasse /
energy efficiency class:
A

Markenleuchtmittel inkl.
branded lamp incl.

↑ 10 cm, ↔ 40 cm, ⇨ 10,5 cm

Glas / Glass: 6297



16W
1400
Lumen



2 Braez / Serie 581
4581.02.64.0000
EAN4003474259352
Nickel-matt /
Nickel matt finished

 2 x G9 / 33 W incl.
2700 K / 2 x 460 lm

Energieeffizienzklasse /
energy efficiency class:
D

Markenleuchtmittel inkl.
branded lamp incl.



↑ 22 cm, ↔ 7,5 cm, ⇨ 7,5 cm



4 Jil / Serie 835
4835.01.54.0000
EAN4003474304151
Nickel-matt / Chrom /
Nickel matt finished / Chrome

 1 x LED / 8 W incl.
3000 K / 1 x 700 lm

Energieeffizienzklasse /
energy efficiency class:
A+

Markenleuchtmittel inkl.
branded lamp incl.

↑ 8,5 cm, ↔ 20 cm, ⇨ 10,5 cm

Glas / Glass: 6296



8W
700
Lumen

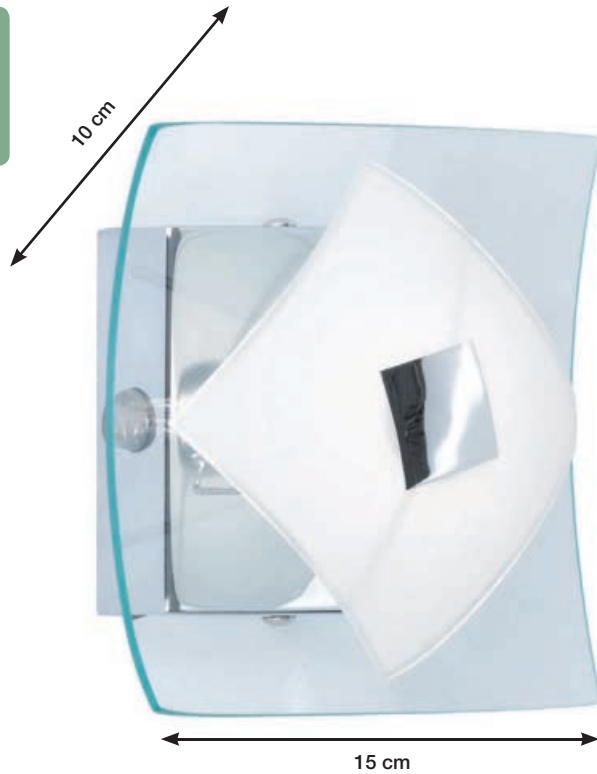

1 Luv / Serie 641
4641.01.01.0000
 EAN4003474269290
 Chrom / Chrome

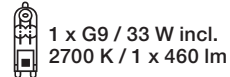

1 x G9 / 33 W incl.
 2700 K / 1 x 460 lm

Energieeffizienzklasse /
 energy efficiency class:



Markenleuchtmittel inkl.
 branded lamp incl.



↓ 15 cm, ↔ 15 cm, ⇨ 8 cm

Glas / Glass:
 6154: 15 x 15 cm
 6155: 10 x 10 cm



3 Kanpur / Serie 419
9419.02.64.0280
 EAN4003474182452
 Nickel-matt / Nickel matt finished
 geeignet für / suitable for /
 Energieeffizienzklasse / energy
 efficiency class:



2 x E14 /
 max.40 W

Fit for LED

↓ 28 cm, ↔ 28 cm, ⇨ 8 cm

Glas / Glass:
 7615: 28 x 28 cm
 7616: 21 x 21 cm



2 Luv / Serie 641
7641.02.01.0000
 EAN4003474269306
 Chrom / Chrome



2 x G9 / 33 W incl.
 2700 K / 2 x 460 lm

Energieeffizienzklasse /
 energy efficiency class:



Markenleuchtmittel inkl.
 branded lamp incl.



↓ 15 cm, ↔ 32 cm, ⇨ 8 cm

Glas / Glass:
 6154: 15 x 15 cm
 6155: 10 x 10 cm



*Das richtige Glas
 macht das richtige Licht*
 ...Perfect glass for perfect light



4 Figo / Serie 637
9637.01.64.0210
 EAN4003474168821
 Nickel-matt / Nickel matt finished
 geeignet für / suitable for /
 Energieeffizienzklasse / energy
 efficiency class:



1 x E14 /
 max.60 W

Fit for LED

↓ 21 cm, ↔ 19 cm, ⇨ 6,5 cm

Glas / Glass: 7041, 21 x 19 cm



1 Zibo / Serie 172
4172.02.06.0000
EAN4003474206417
Weiß / White

2 x G 9 / 33 W incl.
2700 K / 2 x 460 lm

Energieeffizienzklasse /
energy efficiency class:
D

Markenleuchtmittel inkl. /
branded lamp incl.

HALOGEN
ECO

↑ 32,5 cm, ↔ 16 cm,
↳ 8 cm

Glas: opal weiß /
Glass: opal white
Glas / Glass: 7730



2 Zibo / Serie 172
4172.01.06.0000
EAN4003474206424
Weiß / White

1 x G 9 / 33 W incl.
2700 K / 1 x 460 lm

Energieeffizienzklasse /
energy efficiency class:
D

Markenleuchtmittel inkl. /
branded lamp incl.

HALOGEN
ECO

↑ 20 cm, ↔ 16 cm,
↳ 8 cm

Glas: opal weiß /
Glass: opal white
Glas / Glass: 7729

33W
460
Lumen



3 Eddy / Serie 931
4931.02.64.0000
EAN4003474158440
Nickel-matt /
Nickel matt finished
geeignet für / suitable for /
Energieeffizienzklasse /
energy efficiency class:
A++

2 x E 14 /
max.40 W

Fit for LED

↑ 40 cm, ↔ 5 cm, ↳ 8 cm

Glas: opal weiß-matt /
Glass: opal white-matt
Glas / Glass: 7369



4 Aqaba / Serie 451
4451.01.64.0000
EAN4003474207155
Nickel-matt /
Nickel matt finished

1 x G9 / 33 W incl.
2700 K / 1 x 460 lm

Energieeffizienzklasse /
energy efficiency class:
D

Markenleuchtmittel inkl. /
branded lamp incl.

HALOGEN
ECO

↑ 9 cm, Ø 8 cm,
↳ 10 cm

Glas: opal weiß /
Glass: opal white
Glas / Glass: 7932

33W
460
Lumen



5 Aqaba / Serie 451
4451.01.64.0500
EAN4003474218724
Nickel-matt /
Nickel matt finished

1 x G9 / 33 W incl.
2700 K / 1 x 460 lm

Energieeffizienzklasse /
energy efficiency class:
D

Markenleuchtmittel inkl. /
branded lamp incl.

HALOGEN
ECO

↑ 9 cm, Ø 8 cm, ↳ 10 cm

Glas: opal weiß /
Glass: opal white
Glas / Glass: 7932

33W
460
Lumen

Weitere attraktive Wand- und Deckenleuchten finden Sie unter der Kategorie „Produktfamilien“ auf folgenden Seiten:
 Additional attractive wall and ceiling lamps please find in the category „product families“ on the following pages:



Vannes / Serie 625
Seite / Page 013



Colmar / Serie 234
Seite / Page 014 / 015



Kelton / Serie 017
Seite / Page 016



Louvre / Serie 825
Seite / Page 017



Trois / Serie 809
Seite / Page 018



Avignon / Serie 275
Seite / Page 019



Galax / Serie 587
Seite / Page 021

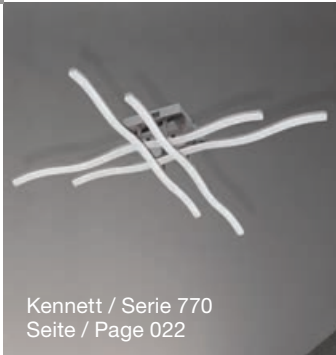

Kennett / Serie 770
Seite / Page 022

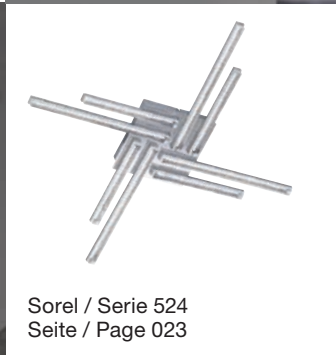

Sorel / Serie 524
Seite / Page 023



Napa / Serie 666
Seite / Page 024



Horton / Serie 786
Seite / Page 025



Logan / Serie 175
Seite / Page 026



Hook / Serie 893
Seite / Page 027



Davis / Serie 507
Seite / Page 028



Segura / Serie 161
Seite / Page 029



Mercur / Serie 313
Seite / Page 031



Montreal / Serie 394
Seite / Page 033



Orbit / Serie 946
Seite / Page 034



Troy / Serie 777
Seite / Page 035



Benett / Serie 557
Seite / Page 036-038



Toulouse / Serie 997
Seite / Page 047



Troja / Serie 973
Seite / Page 049

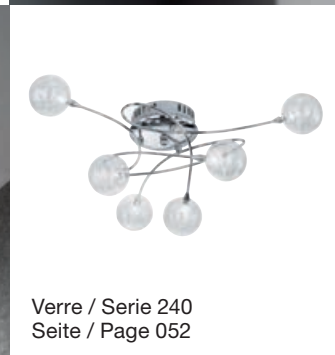

Verre / Serie 240
Seite / Page 052

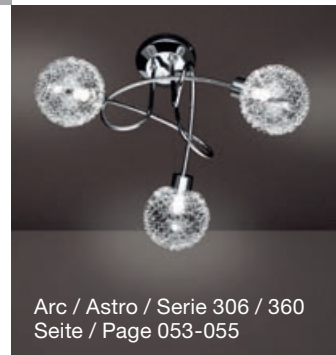

Arc / Astro / Serie 306 / 360
Seite / Page 053-055



Strahlerserien

...Spotlight range

Bringen Licht auf den Punkt

Pures Design und eine effiziente Technologie lassen unsere Spots – im wahrsten Sinne des Wortes – erstrahlen! Optimal für punktuelle Lichtquellen im Wohnraum.

Focused lighting

Pure designs and efficient technology quite literally make our spotlights shine. Ideal if you need focused light sources in your home.

Hook	112
Morris	113
Fulton	114
Chloe	115
Vileta	116
Atkins	117
Antibes	118
Maar	119
Colo	120
Steele	121
Cameron	122
Eve	123
Quincy	124
Marco	125
Angola	126
Nini	128

LED Light
by WOFI®

8W
600
Lumen



1 Hook / Serie 893
9893.06.54.0000
EAN4003474306094
Nickel-matt / Chrom /
Nickel matt finished / Chrome

6 x LED / 8 W incl.
3000 K / 6 x 600 lm

Energieeffizienzklasse /
energy efficiency class:

A+

Markenleuchtmittel inkl.
branded lamp incl.

↔ 180 cm, ↗ 10 cm, ⊥ 18,5 cm

Glas / Glass: 6316, Ø 10 cm

Dimmbar mittels geeignetem
Wanddimmer / dimmable by
suitable wall dimmer



Weitere Leuchten zu
dieser Serie finden Sie
auf Seite 027

You'll find matching
products on page 027

Neu!

Neu!

Kein Widerspruch
mehr: Licht an, Spot an
...No opposition: Lights on, Spots on



3 Hook / Serie 893
7893.02.54.0000
EAN4003474306087
Nickel-matt / Chrom /
Nickel matt finished / Chrome

2 x LED / 8 W incl.
3000 K / 2 x 600 lm

Energieeffizienzklasse /
energy efficiency class:

A+

Markenleuchtmittel inkl.
branded lamp incl.

↔ 38 cm, ↗ 10 cm, ⊥ 20 cm

Glas / Glass: 6316, Ø 10 cm



4 Hook / Serie 893
9893.04.54.0000
EAN4003474304021
Nickel-matt / Chrom /
Nickel matt finished / Chrome

4 x LED / 8 W incl.
3000 K / 4 x 600 lm

Energieeffizienzklasse /
energy efficiency class:

A

Markenleuchtmittel inkl.
branded lamp incl.

↔ 76 cm, ↗ 10 cm, ⊥ 18,5 cm

Glas / Glass: 6316, Ø 10 cm

Dimmbar mittels geeignetem
Wanddimmer /
dimmable by suitable wall
dimmer



6316

2 Hook / Serie 893
4893.01.54.0000
EAN4003474306070
Nickel-matt / Chrom /
Nickel matt finished / Chrome

1 x LED / 8 W incl.
3000 K / 1 x 600 lm

Energieeffizienzklasse /
energy efficiency class:

A

Markenleuchtmittel inkl.
branded lamp incl.

↔ 10 cm, ⊥ 10 cm, ⊥ 17 cm

Glas / Glass: 6316, Ø 10 cm



1 Morris / Serie 224
4224.01.01.0000
 EAN4003474301464
 Chrom / Chrome

 1 x LED / 5 W incl.
 3000 K / 1 x 400 lm

Energieeffizienzklasse /
 energy efficiency class:

A+

Markenleuchtmittel inkl.
 branded lamp incl.

Ø 10 cm, | 16 cm



5W

 400
 Lumen



Neu!
New!



2 Morris / Serie 224
7224.04.01.0000
 EAN4003474301457
 Chrom / Chrome

 4 x LED / 5 W incl.
 3000 K / 4 x 400 lm

Energieeffizienzklasse /
 energy efficiency class:

A

Markenleuchtmittel inkl.
 branded lamp incl.

↔ 71,5 cm, ↗ 12 cm, ⊥ 21 cm

3 Morris / Serie 224
7224.02.01.0000
 EAN4003474301440
 Chrom / Chrome

 2 x LED / 5 W incl.
 3000 K / 2 x 400 lm

Energieeffizienzklasse /
 energy efficiency class:

A

Markenleuchtmittel inkl.
 branded lamp incl.

↔ 36,5 cm, ↗ 13 cm, ⊥ 20,5 cm

4 Morris / Serie 224
9224.06.01.0000
 EAN4003474299976
 Chrom / Chrome

 6 x LED / 5 W incl.
 3000 K / 6 x 400 lm

Energieeffizienzklasse /
 energy efficiency class:

A

Markenleuchtmittel inkl.
 branded lamp incl.

↔ 80 cm, ↗ 27,5 cm, ⊥ 20 cm



5 Morris / Serie 224
9224.06.01.3000
 EAN4003474300801
 Chrom / Chrome

 6 x LED / 5 W incl.
 3000 K / 6 x 400 lm

Energieeffizienzklasse /
 energy efficiency class:

A

Markenleuchtmittel inkl.
 branded lamp incl.

↔ 180 cm, ↗ 13 cm, ⊥ 22,5 cm



LED Light
by **WOFI**



Macht Räumlichkeiten lebendig

...Brings rooms to life

1 Fulton / Serie 740
9740.06.01.0000
EAN4003474306063
Chrom / Chrome



6 x LED / 6 W incl.
3000 K / 6 x 500 lm

Energieeffizienzklasse /
energy efficiency class:

A+

Markenleuchtmittel inkl.
branded lamp incl.

↔ 177 cm, ↗ 7,5 cm,
⏚ 20,5 cm

Glas / Glass: 8021, Ø 7,4 cm



8021



3 Fulton / Serie 740
9740.03.01.0000
EAN4003474304120
Chrom / Chrome



3 x LED / 6 W incl.
3000 K / 3 x 500 lm

Energieeffizienzklasse /
energy efficiency class:

A+

Markenleuchtmittel inkl.
branded lamp incl.

Ø 30 cm, ⏚ 19 cm

Glas / Glass: 8021, Ø 7,4 cm



6W

500
Lumen



4 Fulton / Serie 740
7740.02.01.1000
EAN4003474304106
Chrom / Chrome



2 x LED / 6 W incl.
3000 K / 2 x 500 lm

Energieeffizienzklasse /
energy efficiency class:

A+

Markenleuchtmittel inkl.
branded lamp incl.

↔ 32 cm, ↗ 7 cm, ⏚ 19 cm

Glas / Glass: 8021, Ø 7,4 cm

5 Fulton / Serie 740
7740.04.01.1000
EAN4003474306223
Chrom / Chrome



4 x LED / 6 W incl.
3000 K / 4 x 500 lm

Energieeffizienzklasse /
energy efficiency class:

A+

Markenleuchtmittel inkl.
branded lamp incl.

↔ 80 cm, ↗ 7,5 cm, ⏚ 19 cm

Glas / Glass: 8021, Ø 7,4 cm

2 Fulton / Serie 740
4740.01.01.0000
EAN4003474304090
Chrom / Chrome



1 x LED / 6 W incl.
3000 K / 1 x 500 lm

Energieeffizienzklasse /
energy efficiency class:

A+

Markenleuchtmittel inkl.
branded lamp incl.

↔ 17 cm, ⏚ 16 cm

Glas / Glass: 8021, Ø 7,4 cm



Weitere Leuchten zu dieser Serie finden Sie auf Seite 041
You'll find matching products on page 041

1 Chloe / Serie 195
9195.06.01.0500
 EAN4003474289236
 Chrom / Chrome

 6 x LED / 5 W incl.
 3000 K / 6 x 300 lm

Energieeffizienzklasse /
 energy efficiency class:

A

Markenleuchtmittel inkl.
 branded lamp incl.

↔ 180 cm, ⊥ 15 cm



**Viel Licht auf
 kleinem Raum**
 ...lot of light in a little space

2 Chloe / Serie 195
7195.02.01.0000
 EAN4003474289212
 Chrom / Chrome

 2 x LED / 5 W incl.
 3000 K / 2 x 300 lm

Energieeffizienzklasse /
 energy efficiency class:

A

Markenleuchtmittel inkl.
 branded lamp incl.

↔ 36,5 cm, ⊥ 10 cm



5 Chloe / Serie 195
4195.01.01.0000
 EAN4003474289205
 Chrom / Chrome

 1 x LED / 5 W incl.
 3000 K / 1 x 300 lm

Energieeffizienzklasse /
 energy efficiency class:

A

Markenleuchtmittel inkl.
 branded lamp incl.

Ø 9 cm, ⊥ 15 cm



3 Chloe / Serie 195
9195.04.01.0500
 EAN4003474289229
 Chrom / Chrome

 4 x LED / 5 W incl.
 3000 K / 4 x 300 lm

Energieeffizienzklasse /
 energy efficiency class:

A

Markenleuchtmittel inkl.
 branded lamp incl.

↔ 92 cm, ⊥ 15 cm

4 Chloe / Serie 195
9195.06.01.0000
 EAN4003474281599
 Chrom / Chrome

 6 x LED / 5 W incl.
 3000 K / 6 x 300 lm

Energieeffizienzklasse /
 energy efficiency class:

A

Markenleuchtmittel inkl.
 branded lamp incl.

Ø 35 cm, ⊥ 10 cm



6 Chloe / Serie 195
9195.04.01.0000
 EAN4003474283746
 Chrom / Chrome

 4 x LED / 5 W incl.
 3000 K / 4 x 300 lm

Energieeffizienzklasse /
 energy efficiency class:

A

Markenleuchtmittel inkl.
 branded lamp incl.

Ø 30 cm, ⊥ 10 cm



LED Light
by WOFI®

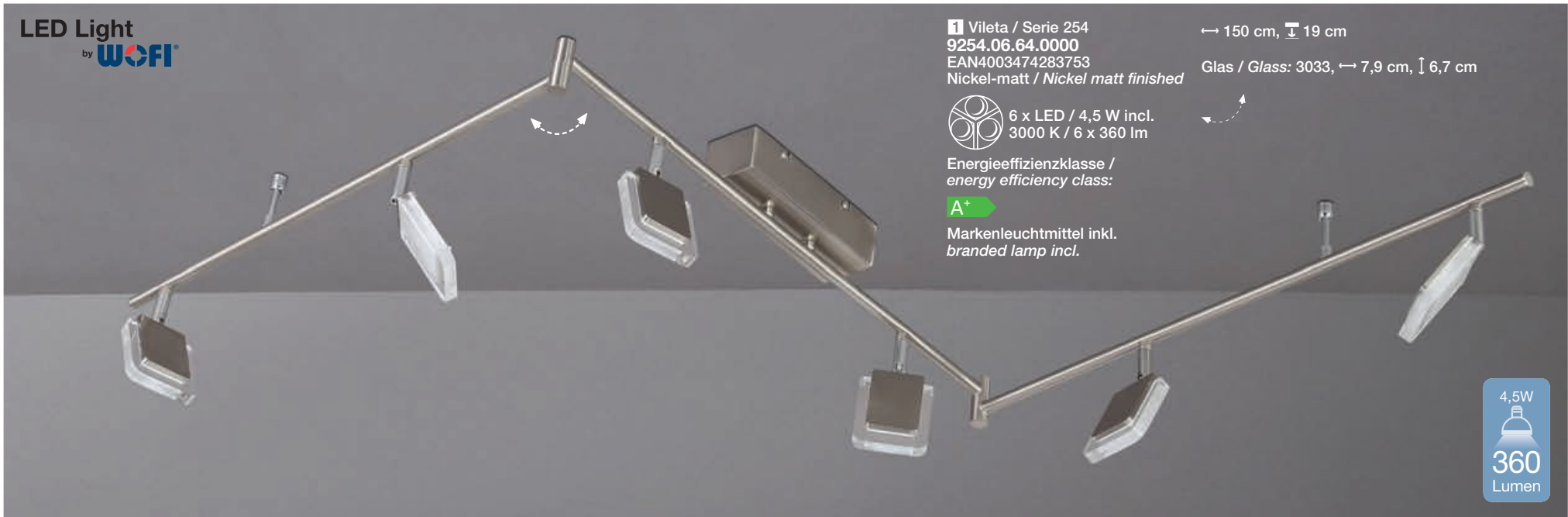

1 Vileta / Serie 254
9254.06.64.0000
EAN4003474283753
Nickel-matt / Nickel matt finished

↔ 150 cm, ↓ 19 cm

Glas / Glass: 3033, ↔ 7,9 cm, ↓ 6,7 cm

 6 x LED / 4,5 W incl.
3000 K / 6 x 360 lm

Energieeffizienzklasse /
energy efficiency class:

A+

Markenleuchtmittel inkl.
branded lamp incl.

4,5W

360
Lumen



3033



2 Vileta / Serie 254
4254.01.64.0000
EAN4003474132662
Nickel-matt /
Nickel matt finished

Markenleuchtmittel inkl.
branded lamp incl.

↓ 8,5 cm, ↔ 8,5 cm,
↔ 16,5 cm

 1 x LED / 4,5 W incl.
3000 K / 1 x 360 lm

Glas / Glass: 3033,
↔ 7,9 cm, ↓ 6,7 cm

Energieeffizienzklasse /
energy efficiency class:

A+



3 Vileta / Serie 254
4254.01.64.0500
EAN4003474281933
Nickel-matt /
Nickel matt finished

Markenleuchtmittel inkl.
branded lamp incl.

↓ 8,5 cm, ↔ 8,5 cm,
↔ 31 cm

 1 x LED / 4,5 W incl.
3000 K / 1 x 360 lm

Glas / Glass: 3033,
↔ 7,9 cm, ↓ 6,7 cm

Energieeffizienzklasse /
energy efficiency class:

A+



4 Vileta / Serie 254
9254.04.64.0000
EAN4003474281926
Nickel-matt /
Nickel matt finished

 4 x LED / 4,5 W incl.
3000 K / 4 x 360 lm

Energieeffizienzklasse /
energy efficiency class:

A+

Markenleuchtmittel inkl.
branded lamp incl.

↔ 80 cm, ↓ 19 cm

Glas / Glass: 3033,
↔ 7,9 cm, ↓ 6,7 cm



5 Vileta / Serie 254
7254.02.64.0000
EAN4003474128566
Nickel-matt /
Nickel matt finished

 2 x LED / 4,5 W incl.
3000 K / 2 x 360 lm

Energieeffizienzklasse /
energy efficiency class:

A+

Markenleuchtmittel inkl.
branded lamp incl.

↔ 35 cm, ↓ 19 cm

Glas / Glass: 3033,
↔ 7,9 cm, ↓ 6,7 cm

Weitere
Leuchten zu
dieser Serie
finden Sie auf
Seite 83

You'll find
matching
products on
page 83

Neu!
Neu!



1 Atkins / Serie 729
9729.03.01.0000
EAN4003474306261
Chrom / Chrome

3 x LED / 5 W incl.
3000 K / 3 x 400 lm
Energieeffizienzklasse /
energy efficiency class:
A+

Markenleuchtmittel inkl.
branded lamp incl.
Ø 44 cm, \downarrow 15 cm
Glas / Glass: 6293
 \downarrow 10 cm, \leftrightarrow 3,6 cm

5W

400
Lumen



2 Atkins / Serie 729
9729.06.01.0500
EAN4003474306278
Chrom / Chrome

6 x LED / 5 W incl.
3000 K / 6 x 400 lm

Energieeffizienzklasse /
energy efficiency class:
A+
Markenleuchtmittel inkl.
branded lamp incl.
Ø 45,5 cm, \downarrow 15 cm
Glas / Glass: 6293, \downarrow 10 cm, \leftrightarrow 3,6 cm

3 Atkins / Serie 729
7729.02.01.0000
EAN4003474306155
Chrom / Chrome

2 x LED / 5 W incl.
3000 K / 2 x 400 lm
Energieeffizienzklasse /
energy efficiency class:
A+

Markenleuchtmittel inkl.
branded lamp incl.
 \leftrightarrow 36 cm, \downarrow 18 cm

Glas / Glass: 6293
 \downarrow 10 cm, \leftrightarrow 3,6 cm

4 Atkins / Serie 729
7729.04.01.0000
EAN4003474306162
Chrom / Chrome

4 x LED / 5 W incl.
3000 K / 4 x 400 lm
Energieeffizienzklasse /
energy efficiency class:
A+

Markenleuchtmittel inkl.
branded lamp incl.
 \leftrightarrow 90 cm, \nearrow 9 cm, \downarrow 18,5 cm

Glas / Glass: 6293, \downarrow 10 cm, \leftrightarrow 3,6 cm



LED Light
by **WOFI**

5 Atkins / Serie 729
4729.01.01.0000
EAN4003474306148
Chrom / Chrome

1 x LED / 5 W incl.
3000 K / 1 x 400 lm
Energieeffizienzklasse /
energy efficiency class:
A+

Markenleuchtmittel inkl.
branded lamp incl.
Ø 8 cm, \downarrow 15,5 cm
Glas / Glass: 6293
 \downarrow 10 cm, \leftrightarrow 3,6 cm

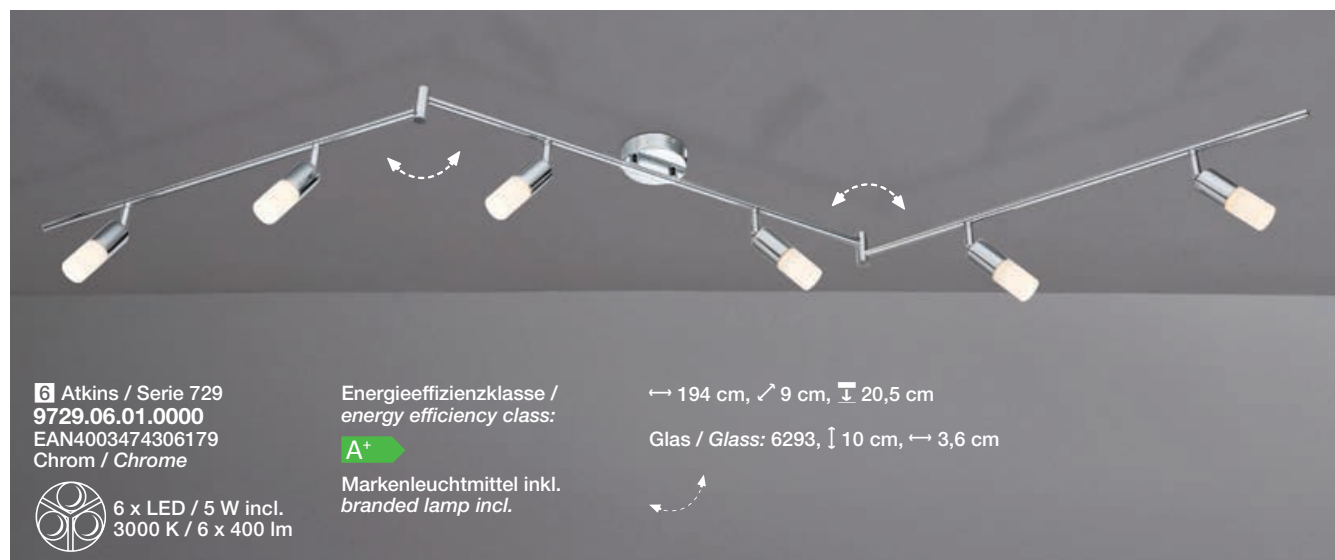

6 Atkins / Serie 729
9729.06.01.0000
EAN4003474306179
Chrom / Chrome

6 x LED / 5 W incl.
3000 K / 6 x 400 lm

Energieeffizienzklasse /
energy efficiency class:
A+
Markenleuchtmittel inkl.
branded lamp incl.

\leftrightarrow 194 cm, \nearrow 9 cm, \downarrow 20,5 cm
Glas / Glass: 6293, \downarrow 10 cm, \leftrightarrow 3,6 cm

LED Light
by WOFI®



1 Antibes / Serie 792
9792.10.01.0000
EAN4003474289410
Chrom / Chrome

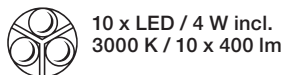

Energieeffizienzklasse /
energy efficiency class:

A+

Markenleuchtmittel inkl. /
branded lamp incl.

↔ 200 cm, ↗ 16 cm, ↓ 17,5 cm

Glas / Glass: 1386, Ø 5 cm, ↓ 4,5 cm

getrennt schaltbar über Wandschal-
ter oder Fernbedienung /
separately switchable by wall switch
or remote control



2 Antibes / Serie 792
9792.06.01.0300
EAN4003474289373
Chrom / Chrome

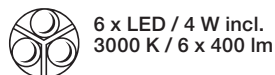

Energieeffizienzklasse /
energy efficiency class:

A+

Markenleuchtmittel inkl. /
branded lamp incl.

Ø 34 cm, ↓ 15 cm

Glas / Glass: 1386,
Ø 5 cm, ↓ 4,5 cm

getrennt schaltbar über
Wandschalter oder
Fernbedienung /
separately switchable by
wall switch
or remote control



4W
400
Lumen

Licht für die Sinne
...Lighting that appeals
to the senses



1 Maar / Serie 806
9806.04.01.0000
 EAN4003474040240
 Chrom / Chrome

4 x LED / 5 W incl.
 3000 K / 4 x 400 lm

Energieeffizienzklasse /
 energy efficiency class:
A+

Markenleuchtmittel inkl. /
 branded lamp incl.

↓ 25 cm, ↔ 25 cm,
 ⊥ 15 cm

Glas / Glass: 3054,
 Ø 5 cm, ↓ 5,9 cm



2 Maar / Serie 806
7806.02.01.0000
 EAN4003474034881
 Chrom / Chrome

2 x LED / 5 W incl.
 3000 K / 2 x 400 lm

Energieeffizienzklasse /
 energy efficiency class:
A+

Markenleuchtmittel inkl. /
 branded lamp incl.

↓ 7,5 cm, ↔ 32 cm, ⊥ 15 cm

Glas / Glass: 3054, Ø 5 cm, ↓ 5,9 cm



4 Maar / Serie 806
4806.01.01.0000
 EAN4003474034843
 Chrom / Chrome

LED Light
 by **WOFI**

1 x LED / 5 W incl.
 3000 K / 1 x 400 lm

Energieeffizienzklasse /
 energy efficiency class:
A+

Markenleuchtmittel inkl. /
 branded lamp incl.

↓ 10 cm, ↔ 10 cm, ⊥ 15 cm

Glas / Glass: 3054,
 Ø 5 cm, ↓ 5,9 cm

Licht und Wasser in perfekter Kombination

...Light and water in perfect combination



5W
 400 Lumen

3 Maar / Serie 806
7806.03.01.0000
 EAN4003474269894
 Chrom / Chrome

3 x LED / 5 W incl.
 3000 K / 3 x 400 lm

Energieeffizienzklasse /
 energy efficiency class:
A+

Markenleuchtmittel inkl. /
 branded lamp incl.

↓ 7,5 cm, ↔ 45,5 cm, ⊥ 15 cm

Glas / Glass: 3054,
 Ø 5 cm, ↓ 5,9 cm



1 Colo / Serie 377
9377.04.64.0000
EAN4003474273341
Nickel-matt /
Nickel matt finished



4 x LED / 5 W incl.
3000 K / 4 x 400 lm

Energieeffizienzklasse /
energy efficiency class:



Markenleuchtmittel inkl.
branded lamp incl.

↔ 93 cm, ⊥ 18,5 cm

Glas: weiß gewischt /
Glass: white wipe
technique
Glas / Glass: 6227
Ø 6 cm, ↔ 9 cm



2 Colo / Serie 377
9377.06.64.0000
EAN4003474273365
Nickel-matt /
Nickel matt finished



6 x LED / 5 W incl.
3000 K / 6 x 400 lm

Energieeffizienzklasse /
energy efficiency class:



Markenleuchtmittel inkl.
branded lamp incl.

↔ 188 cm, ⊥ 23 cm

Glas: weiß gewischt /
Glass: white wipe technique
Glas / Glass: 6227
Ø 6 cm, ↔ 9 cm



3 Colo / Serie 377
4377.01.64.0000
EAN4003474273327
Nickel-matt /
Nickel matt finished



1 x LED / 5 W incl.
3000 K / 1 x 400 lm

Energieeffizienzklasse /
energy efficiency class:



Markenleuchtmittel inkl.
branded lamp incl.

Ø 11 cm, ⊥ 18 cm

Glas: weiß gewischt /
Glass: white wipe technique
Glas / Glass: 6227
Ø 6 cm, ↔ 9 cm



4 Colo / Serie 377
7377.02.64.0000
EAN4003474273334
Nickel-matt /
Nickel matt finished



2 x LED / 5 W incl.
3000 K / 2 x 400 lm

Energieeffizienzklasse /
energy efficiency class:



Markenleuchtmittel inkl.
branded lamp incl.

↔ 44 cm, ⊥ 19 cm

Glas: weiß gewischt /
Glass: white wipe technique
Glas / Glass: 6227
Ø 6 cm, ↔ 9 cm

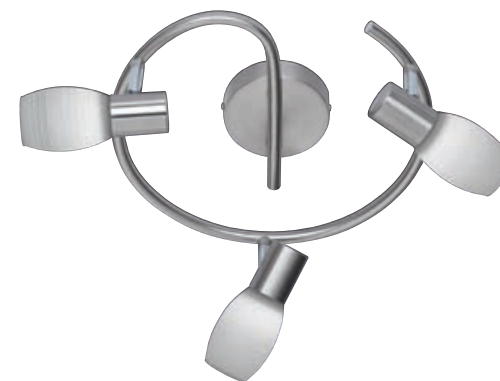

5 Colo / Serie 377
9377.03.64.0000
EAN4003474273358
Nickel-matt /
Nickel matt finished



3 x LED / 5 W incl.
3000 K / 3 x 400 lm

Energieeffizienzklasse /
energy efficiency class:



Markenleuchtmittel inkl.
branded lamp incl.

Ø 38 cm, ⊥ 18,5 cm

Glas: weiß gewischt /
Glass: white wipe technique
Glas / Glass: 6227
Ø 6 cm, ↔ 9 cm



LED Light
by **WOFI**



1 Steele / Serie 346
4346.01.01.0000
EAN4003474301433
Chrom / Chrome

Markenleuchtmittel inkl.
branded lamp incl.

Ø 10 cm, ↗ 10 cm, |↔ 12 cm

Glas / Glass: 6119, ↔ 6,4 cm

1 x LED / 5 W incl.
3000 K / 1 x 460 lm

Energieeffizienzklasse /
energy efficiency class:
A+



Neu!

Neu!



3 Steele / Serie 346
7346.02.01.0000
EAN4003474301655
Chrom / Chrome

 2 x LED / 5 W incl.
3000 K / 2 x 460 lm

Energieeffizienzklasse /
energy efficiency class:

A+

Markenleuchtmittel inkl.
branded lamp incl.

↔ 36,5 cm, ↗ 13 cm, |↔ 20,5 cm

Glas / Glass: 6119, ↔ 6,4 cm

Charmante Spots

...Charming spots

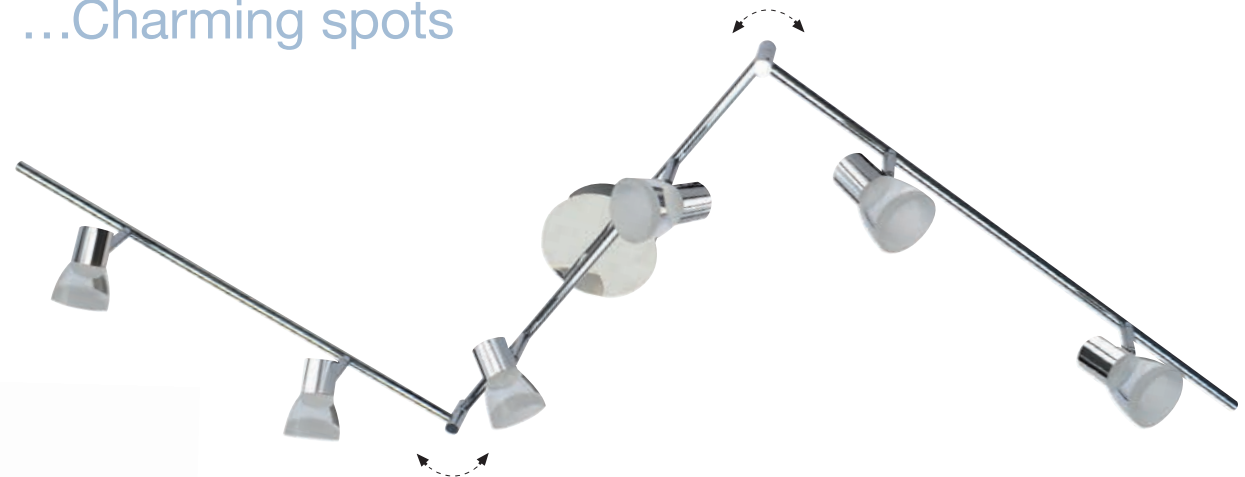

2 Steele / Serie 346
9346.04.01.0000
EAN4003474301662
Chrom / Chrome

 4 x LED / 5 W incl.
3000 K / 4 x 460 lm

Energieeffizienzklasse /
energy efficiency class:

A+

Markenleuchtmittel inkl.
branded lamp incl.

↔ 71,5 cm, ↗ 13 cm, |↔ 21 cm

Glas / Glass: 6119, ↔ 6,4 cm

5W

460
Lumen

LED-Spots in Bestform

Die Serie STEELE überzeugt durch gutes Aussehen und eine intelligente Drehvorrichtung.

LED spots in top shape

The STEELE series combines great look with an intelligent pivoting mechanism.

4 Steele / Serie 346
9346.06.01.0000
EAN4003474306216
Chrom / Chrome

 6 x LED / 5 W incl.
3000 K / 6 x 460 lm

Energieeffizienzklasse /
energy efficiency class:

A+

Markenleuchtmittel inkl.
branded lamp incl.

↔ 180 cm, ↗ 13 cm, |↔ 22,5 cm

Glas / Glass: 6119, ↔ 6,4 cm

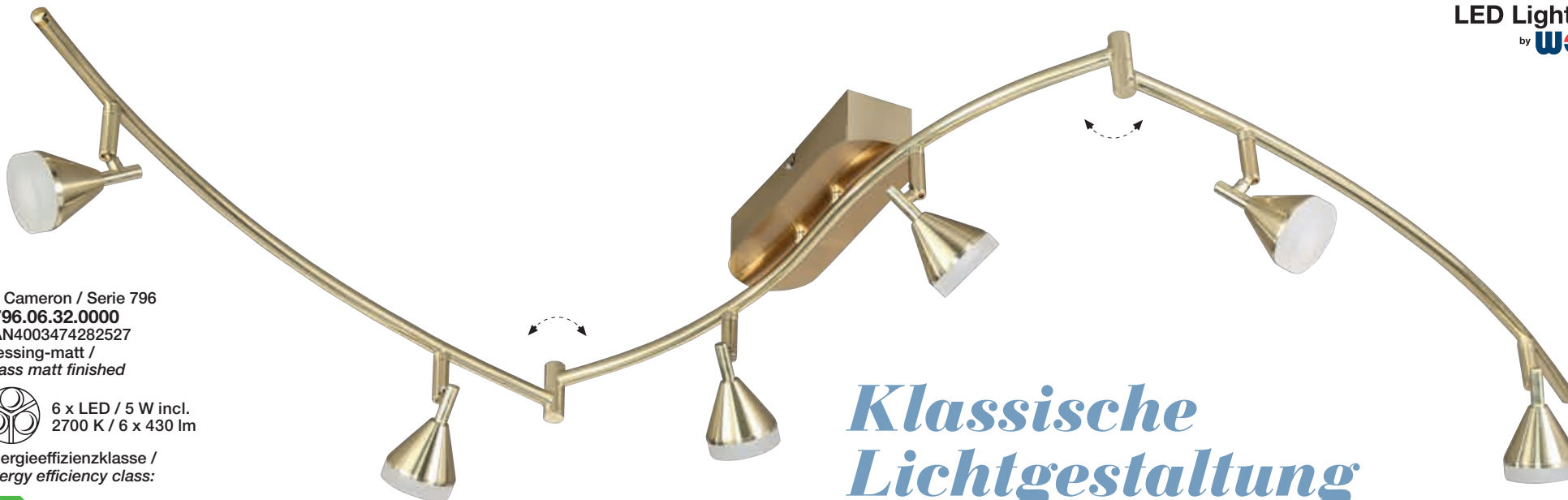

1 Cameron / Serie 796
9796.06.32.0000
EAN4003474282527
Messing-matt /
Brass matt finished

 6 x LED / 5 W incl.
2700 K / 6 x 430 lm

Energieeffizienzklasse /
energy efficiency class:

A+

Markenleuchtmittel inkl. /
branded lamp incl.

↔ 180 cm, ⊥ 16,7 cm

Klassische Lichtgestaltung ...Classical lighting



2 Cameron / Serie 796
7796.02.32.0000
EAN4003474282480
Messing-matt /
Brass matt finished

 2 x LED / 5 W incl.
2700 K / 2 x 430 lm

Energieeffizienzklasse /
energy efficiency class:

A+

Markenleuchtmittel inkl. /
branded lamp incl.

↔ 35,5cm, ⊥ 14,5 cm



3 Cameron / Serie 796
9796.04.32.0000
EAN4003474282503
Messing-matt /
Brass matt finished

 4 x LED / 5 W incl.
2700 K / 4 x 430 lm

Energieeffizienzklasse /
energy efficiency class:

A+

Markenleuchtmittel inkl. /
branded lamp incl.

↔ 70 cm, ⊥ 15 cm, ↗ 39 cm

5W

430
Lumen



4 Cameron / Serie 796
4796.01.32.0000
EAN4003474282466
Messing-matt /
Brass matt finished

 1 x LED / 5 W incl.
2700 K / 1 x 430 lm

Energieeffizienzklasse /
energy efficiency class:

A+

Markenleuchtmittel inkl. /
branded lamp incl.

⊥ 13 cm, ↔ 7,5 cm, ↗ 11 cm

LED Light
by WOFI



1 Eve / Serie 361
9361.06.09.0000
EAN4003474281414
Antik braun / Antique brown

 6 x LED / 5 W incl.
3000 K / 6 x 380 lm

Energieeffizienzklasse /
energy efficiency class: \leftrightarrow 157 cm, \downarrow 21 cm

A+

Markenleuchtmittel inkl. /
branded lamp incl.

Glas / Glass: 6622,
 \varnothing 7 cm

5W

380
Lumen



4 Eve / Serie 361
7361.02.09.0000
EAN4003474281360
Antik braun / Antique brown

 2 x LED / 5 W incl.
3000 K / 2 x 380 lm

Energieeffizienzklasse /
energy efficiency class: **A+**

A+



6 Eve / Serie 361
9361.04.09.0000
EAN4003474281391
Antik braun / Antique brown

 4 x LED / 5 W incl.
3000 K / 4 x 380 lm

Energieeffizienzklasse /
energy efficiency class: **A+**

A+

Markenleuchtmittel inkl. /
branded lamp incl.

\leftrightarrow 72 cm, \downarrow 20 cm

Glas / Glass: 6622, \varnothing 7 cm

3 Eve / Serie 361
4361.01.09.0000
EAN4003474281346
Antik braun / Antique brown

 1 x LED / 5 W incl.
3000 K / 1 x 380 lm

Energieeffizienzklasse /
energy efficiency class: **A+**

A+

Markenleuchtmittel inkl. /
branded lamp incl.

\varnothing 8 cm, \rightarrow 19 cm

Glas / Glass: 6622,
 \varnothing 7 cm



2 Eve / Serie 361
9361.06.64.0000
EAN4003474281421
Nickel-matt /
Nickel matt finished

 6 x LED / 5 W incl.
3000 K / 6 x 380 lm

Energieeffizienzklasse /
energy efficiency class: **A+**

A+

Markenleuchtmittel inkl. /
branded lamp incl.

\leftrightarrow 157 cm, \downarrow 21 cm

Glas / Glass: 6622,
 \varnothing 7 cm

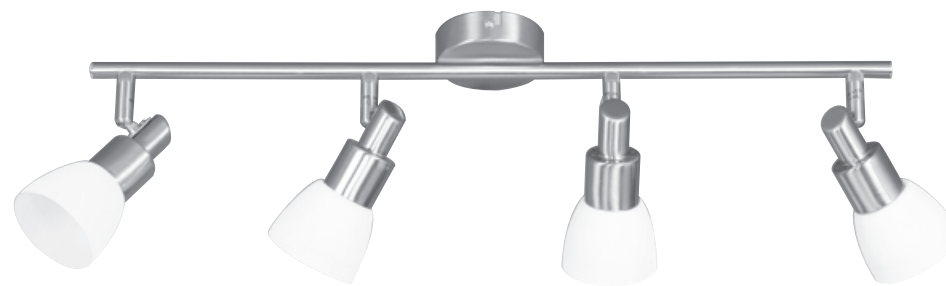

5 Eve / Serie 361
9361.04.64.0000
EAN4003474281407
Nickel-matt /
Nickel matt finished

 4 x LED / 5 W incl.
3000 K / 4 x 380 lm

Energieeffizienzklasse /
energy efficiency class: **A+**

A+

Markenleuchtmittel inkl. /
branded lamp incl.

\leftrightarrow 72 cm, \downarrow 20 cm

Glas / Glass: 6622, \varnothing 7 cm



7 Eve / Serie 361
7361.02.64.0000
EAN4003474281377
Nickel-matt /
Nickel matt finished

 2 x LED / 5 W incl.
3000 K / 2 x 380 lm

Energieeffizienzklasse /

energy efficiency class: **A+**

A+

Markenleuchtmittel inkl. /
branded lamp incl.

\leftrightarrow 40 cm, \downarrow 20 cm

Glas / Glass: 6622, \varnothing 7 cm



8 Eve / Serie 361
4361.01.64.0000
EAN4003474281353
Nickel-matt /
Nickel matt finished

 1 x LED / 5 W incl.
3000 K / 1 x 380 lm

Energieeffizienzklasse /
energy efficiency class: **A+**

A+

Markenleuchtmittel
inkl. / branded lamp
incl.

\varnothing 8 cm, \rightarrow 19 cm

Glas / Glass: 6622,
 \varnothing 7 cm





1 Quincy / Serie 116
9116.06.01.0000
 EAN4003474251134
 Chrom / Chrome

Energieeffizienzklasse /
 energy efficiency class:
A++

Markenleuchtmittel inkl.
 branded lamp incl.

↳ 171 cm, ⊥ 14 cm

1 x GU10 / 3 W incl.
 3000 K / 6 x 250 lm



2 Quincy / Serie 116
4116.01.01.00000
 EAN4003474250991
 Chrom / Chrome

Energieeffizienzklasse /
 energy efficiency class:
A++

Markenleuchtmittel inkl.
 branded lamp incl.

Ø 14 cm, ↳ 14 cm

1 x GU10 / 3 W incl.
 3000 K / 1 x 250 lm



3 Quincy / Serie 116
7116.03.01.0000
 EAN4003474251073
 Chrom / Chrome

Energieeffizienzklasse /
 energy efficiency class:
A++

Markenleuchtmittel inkl.
 branded lamp incl.

↳ 61 cm, ⊥ 14 cm

3 x GU10 / 3 W incl.
 3000 K / 3 x 250 lm



4 Quincy / Serie 116
7116.03.06.0000
 EAN4003474251080
 Weiß / White

Energieeffizienzklasse /
 energy efficiency class:
A++

Markenleuchtmittel inkl.
 branded lamp incl.

↳ 61 cm, ⊥ 14 cm

3 x GU10 / 3 W incl.
 3000 K / 3 x 250 lm



5 Quincy / Serie 116
4116.01.06.0000
 EAN4003474251004
 Weiß / White

Energieeffizienzklasse /
 energy efficiency class:
A++

Markenleuchtmittel inkl.
 branded lamp incl.

Ø 14 cm, ↳ 14 cm

1 x GU10 / 3 W incl.
 3000 K / 1 x 250 lm

LED Light
 by **WOFI**



6 Quincy / Serie 116
7116.02.06.0000
 EAN4003474251059
 Weiß / White

Energieeffizienzklasse /
 energy efficiency class:
A++

Markenleuchtmittel inkl.
 branded lamp incl.

↳ 34 cm, ⊥ 14 cm

2 x GU10 / 3 W incl.
 3000 K / 2 x 250 lm



7 Quincy / Serie 116
7116.02.01.0000
 EAN4003474251042
 Chrom / Chrome

Energieeffizienzklasse /
 energy efficiency class:
A++

Markenleuchtmittel inkl.
 branded lamp incl.

↳ 34 cm, ⊥ 14 cm

2 x GU10 / 3 W incl.
 3000 K / 2 x 250 lm



8 Quincy / Serie 116
9116.06.06.0000
 EAN4003474251141
 Weiß / White

Energieeffizienzklasse /
 energy efficiency class:
A++

Markenleuchtmittel inkl.
 branded lamp incl.

↳ 171 cm, ⊥ 14 cm

6 x GU10 / 3 W incl.
 3000 K / 6 x 250 lm

Energieeffizienzklasse /
 energy efficiency class:
A++

Markenleuchtmittel inkl.
 branded lamp incl.

↳ 171 cm, ⊥ 14 cm



1 Marco / Serie 076
9076.04.01.0000
 EAN4003474248554
 Chrom / Chrome
 geeignet für / suitable for /
 Energieeffizienzklasse /
 energy efficiency class:

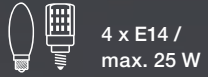

Fit for LED

↑ 42 cm, ↔ 42 cm, ⊥ 19,5 cm

Glas: weiß lackiert mit Klarrand
 Glass: white lacquered with
 clear borde
 Glas / Glass: 6012,
 Ø 4,5 cm, ↔ 10,5 cm,



2 Marco / Serie 076
9076.03.01.0000
 EAN4003474248547
 Chrom / Chrome
 geeignet für / suitable for /
 Energieeffizienzklasse /
 energy efficiency class:

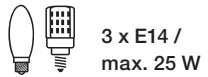

Fit for LED

Ø 36 cm, ⊥ 19,5 cm

Glas: weiß lackiert mit Klarrand
 Glass: white lacquered with
 clear border
 Glas / Glass: 6012,
 Ø 4,5 cm, ↔ 10,5 cm



3 Marco / Serie 076
7076.02.01.0000
 EAN4003474248530
 Chrom / Chrome
 geeignet für / suitable for /
 Energieeffizienzklasse /
 energy efficiency class:



Fit for LED

↑ 12 cm, ↔ 42 cm, ⊥ 19,5 cm

Glas: weiß lackiert mit Klarrand
 Glass: white lacquered with clear
 border
 Glas / Glass: 6012,
 Ø 4,5 cm, ↔ 10,5 cm



4 Marco / Serie 076
4076.01.01.0000
 EAN4003474248523
 Chrom / Chrome
 geeignet für / suitable for /
 Energieeffizienzklasse /
 energy efficiency class:



Fit for LED

↑ 15 cm, ↔ 15 cm, ⇨ 20 cm,

Glas: weiß lackiert mit Klarrand
 Glass: white lacquered with
 clear border
 Glas / Glass: 6012,
 Ø 4,5 cm, ↔ 10,5 cm





1 Angola / Serie 354
7354.03.64.0000
 EAN4003474182803
 Nickel-matt /
 Nickel matt finished

geeignet für / suitable for /
 Energieeffizienzklasse /
 energy efficiency class:

Fit for LED

↔ 60 cm, ⊥ 14 cm

Glas: weiß lackiert /
 Glass: white lacquered
 Glas / Glass: 7505,
 Ø 7 cm, ⊥ 5,6 cm

A++ E

3 x E14 /
 max. 40 W



2 Angola / Serie 354
7354.02.64.0000
 EAN4003474182797
 Nickel-matt /
 Nickel matt finished

geeignet für / suitable for /
 Energieeffizienzklasse /
 energy efficiency class:

Fit for LED

↔ 32 cm, ⊥ 14 cm

Glas: weiß lackiert / Glass: white lacquered
 Glas / Glass: 7505, Ø 7 cm, ⊥ 5,6 cm

A++ E

2 x E14 /
 max. 40 W

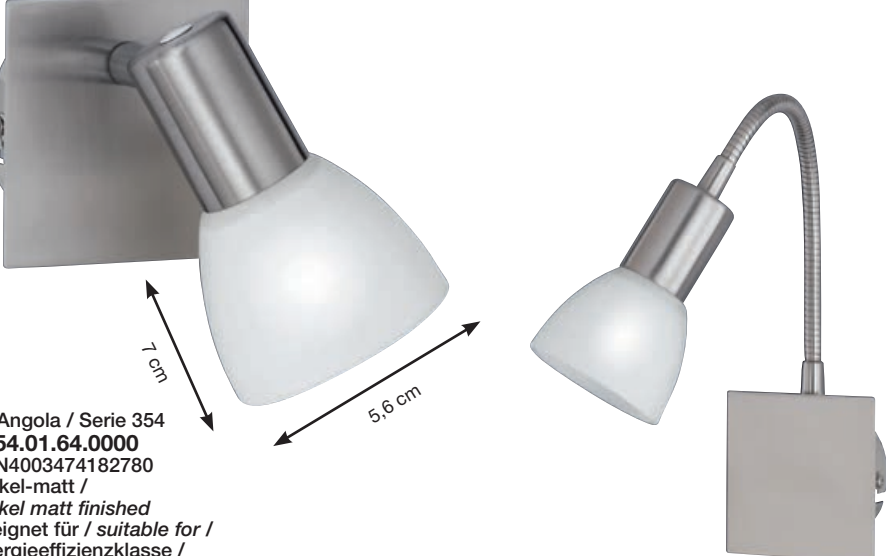

3 Angola / Serie 354
4354.01.64.0000
 EAN4003474182780
 Nickel-matt /
 Nickel matt finished

geeignet für / suitable for /
 Energieeffizienzklasse /
 energy efficiency class:

Fit for LED

↔ 8 cm, ↔ 8 cm, ⊥ 14 cm

Glas: weiß lackiert /
 Glass: white lacquered
 Glas / Glass: 7505, Ø 7 cm, ⊥ 5,6 cm

A++ E

1 x E14 /
 max. 40 W

7 cm

5,6 cm

4 Angola / Serie 354
4354.01.64.0500
 EEAN4003474183381
 Nickel-matt /
 Nickel matt finished

geeignet für / suitable for /
 Energieeffizienzklasse /
 energy efficiency class:

Fit for LED

⊥ 8 cm, ↔ 8 cm, ⊥ 24 cm

Glas: weiß lackiert /
 Glass: white lacquered
 Glas / Glass: 7505, Ø 7 cm, ⊥ 5,6 cm

A++ E

1 x E14 /
 max. 40 W



5 Angola / Serie 354
9354.04.64.0000
 EAN4003474182810
 Nickel-matt /
 Nickel matt finished

geeignet für / suitable for /
 Energieeffizienzklasse /
 energy efficiency class:

Fit for LED

↔ 92 cm, ⊥ 15 cm

Glas: weiß lackiert /
 Glass: white lacquered
 Glas / Glass: 7505,
 Ø 7 cm, ⊥ 5,6 cm

A++ E

4 x E14 /
 max. 40 W



6 Angola / Serie 354
9354.03.64.0000
 EAN4003474183404
 Nickel-matt / Nickel matt finished

geeignet für / suitable for /
 Energieeffizienzklasse /
 energy efficiency class:

Fit for LED

Ø 30 cm, ⊥ 14 cm

Glas: weiß lackiert /
 Glass: white lacquered
 Glas / Glass: 7505, Ø 7 cm, ⊥ 5,6 cm

A++ E

3 x E14 /
 max. 40 W



1 Angola / Serie 354
4354.01.32.1000
 EAN4003474206943
 Messing-matt /
 Brass matt finished
 geeignet für / suitable for /
 Energieeffizienzklasse /
 energy efficiency class:



Fit for LED

↑ 8 cm, ↔ 8 cm, ⇨ 14 cm

Glas: Alabasterfarbig /
 Glass: Alabaster coloured
 Glas / Glass: 7219, Ø 7 cm

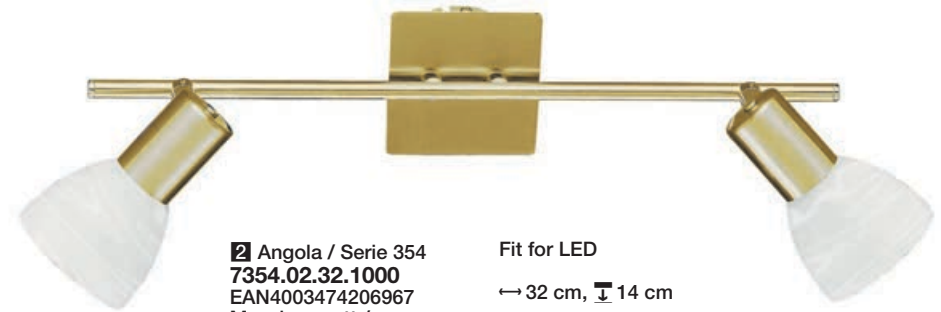

2 Angola / Serie 354
7354.02.32.1000
 EAN4003474206967
 Messing-matt /
 Brass matt finished
 geeignet für / suitable for /
 Energieeffizienzklasse /
 energy efficiency class:



Fit for LED

↔ 32 cm, ↓ 14 cm

Glas: Alabasterfarbig /
 Glass: Alabaster coloured
 Glas / Glass: 7219, Ø 7 cm

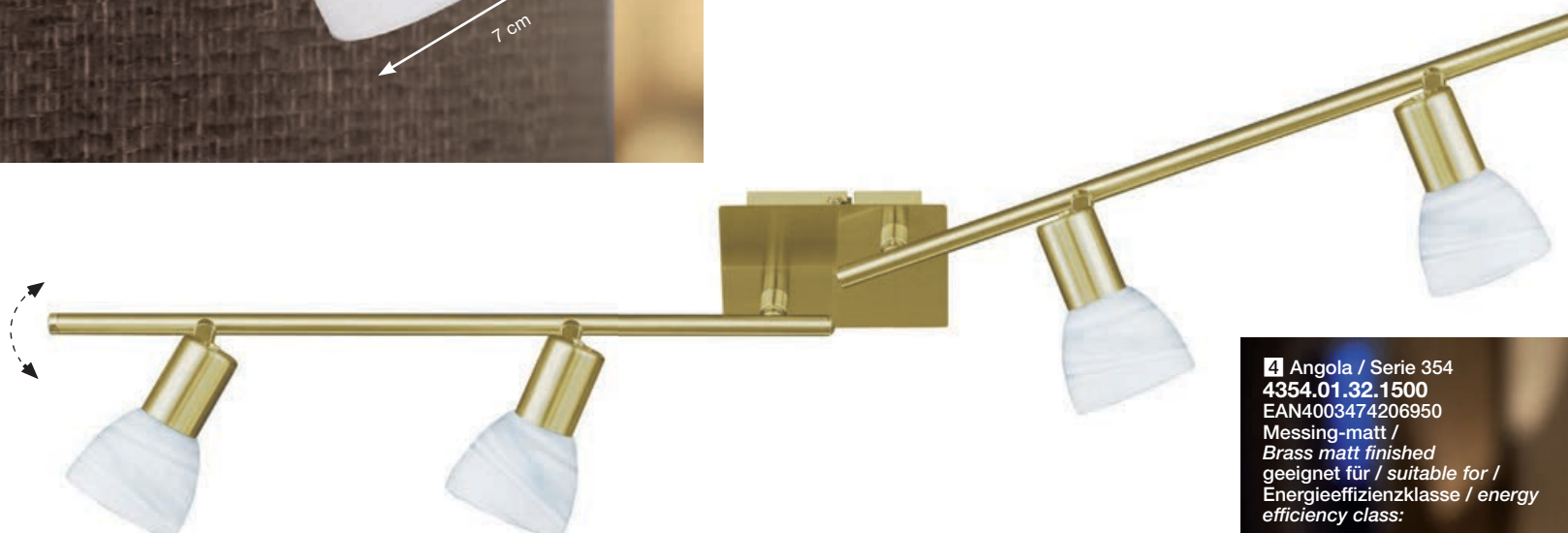

3 Angola / Serie 354
9354.04.32.1000
 EAN4003474206998
 Messing-matt /
 Brass matt finished
 geeignet für / suitable for /
 Energieeffizienzklasse /
 energy efficiency class:



Fit for LED

↔ 92 cm, ↓ 15 cm

Glas: Alabasterfarbig /
 Glass: Alabaster coloured
 Glas / Glass: 7219, Ø 7 cm



4 Angola / Serie 354
4354.01.32.1500
 EAN4003474206950
 Messing-matt /
 Brass matt finished
 geeignet für / suitable for /
 Energieeffizienzklasse /
 energy efficiency class:



Fit for LED

↑ 8 cm, ↔ 8 cm,
 ⇨ 24 cm

Glas: Alabasterfarbig /
 Glass: Alabaster coloured
 Glas / Glass: 7219, Ø 7 cm



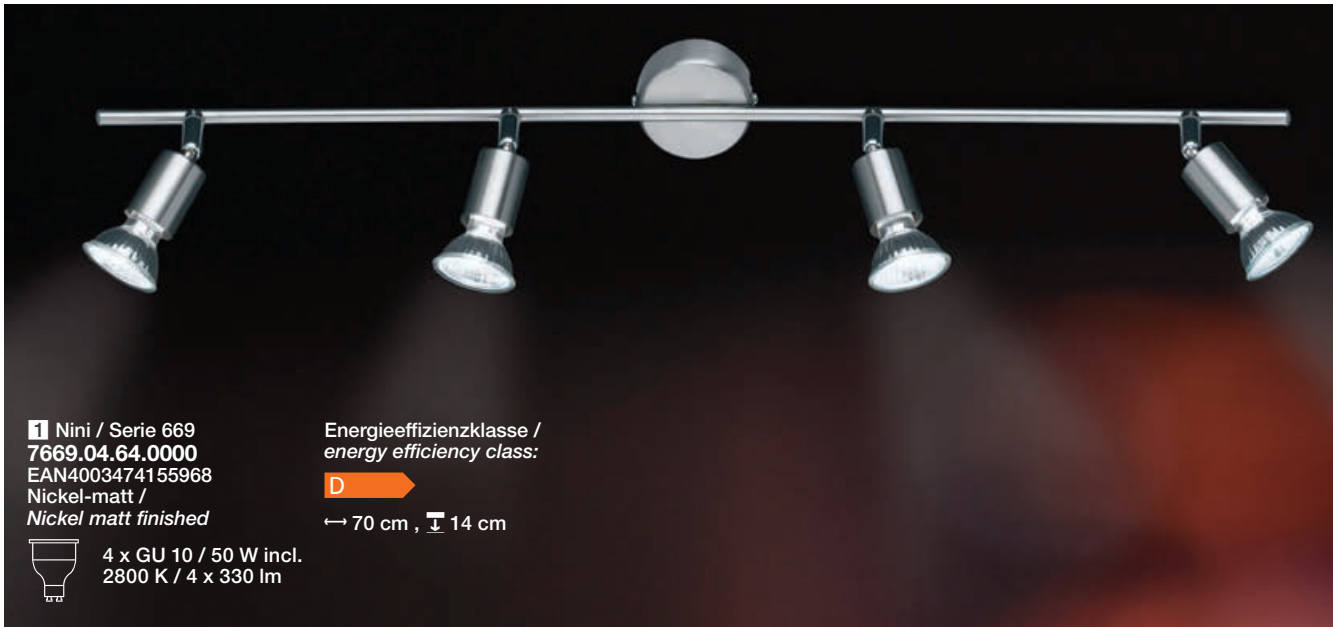

1 Nini / Serie 669
7669.04.64.0000
 EAN4003474155968
 Nickel-matt /
 Nickel matt finished

Energieeffizienzklasse /
 energy efficiency class:



↔ 70 cm, ⊥ 14 cm



4 x GU 10 / 50 W incl.
 2800 K / 4 x 330 lm



2 Nini / Serie 669
4669.01.64.0000
 EAN4003474155920
 Nickel-matt /
 Nickel matt finished

Energieeffizienzklasse /
 energy efficiency class:



Ø 7 cm, ⊥ 14 cm



1 x GU 10 / 50 W incl.
 2800 K / 1 x 330 lm



Minimalismus für Anspruchsvolle

...Minimalism for discerning minds

Vornehme Zurückhaltung

Upscale restraint

Ein Minimum an Design und ein Maximum an Funktionalität bilden die Grundlage der Serie NINI.

Minimal design and utmost practicality are the foundation for the NINI series.



3 Nini / Serie 669
9669.06.64.0000
 EAN4003474150147
 Nickel-matt /
 Nickel matt finished

Energieeffizienzklasse /
 energy efficiency class:



↔ 240 cm, ⊥ 15 cm



6 x GU 10 / 50 W incl.
 2800 K / 6 x 330 lm

50W
330
Lumen



4 Nini / Serie 669
7669.02.64.0000
EAN4003474155944
Nickel-matt /
Nickel matt finished

Energieeffizienzklasse /
energy efficiency class:



↔ 32 cm, ⊥ 14 cm



2 x GU 10 / 50 W incl.
2800 K / 2 x 330 lm

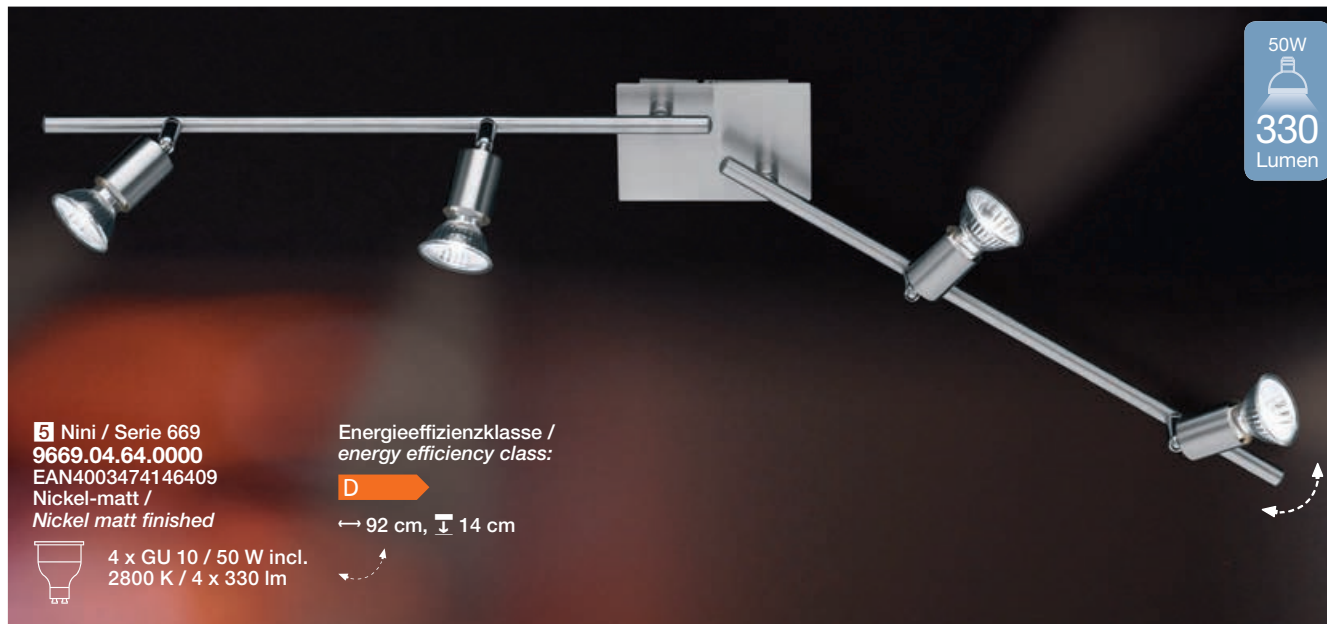

5 Nini / Serie 669
9669.04.64.0000
EAN4003474146409
Nickel-matt /
Nickel matt finished

Energieeffizienzklasse /
energy efficiency class:



↔ 92 cm, ⊥ 14 cm



4 x GU 10 / 50 W incl.
2800 K / 4 x 330 lm

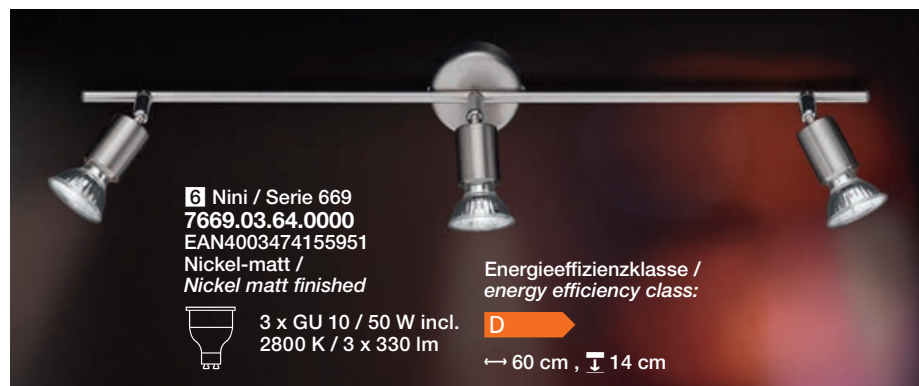

6 Nini / Serie 669
7669.03.64.0000
EAN4003474155951
Nickel-matt /
Nickel matt finished

Energieeffizienzklasse /
energy efficiency class:



↔ 60 cm, ⊥ 14 cm



3 x GU 10 / 50 W incl.
2800 K / 3 x 330 lm



7 Nini / Serie 669
4669.01.64.0500
EAN4003474155937
Nickel-matt /
Nickel matt finished



1 x GU 10 / 50 W incl.
2800 K / 1 x 330 lm

Energieeffizienzklasse /
energy efficiency class:



Ø 7 cm, ↳ 30 cm





SPA *line*

Hoher Wellnessfaktor

Unsere Leuchten der SPA line schaffen eine angenehme Atmosphäre mit hohem Wohlfühlfaktor für Ihren Beauty-Bereich.

Well being on a higher level

Our SPA line collection helps create a pleasant atmosphere with high comfort factor in your beauty area.

Ceres 132	Midu 136
Meran 132	Kent 136
Suri 133	Oasis 136
Pax 133	Maar 137
Luce 133	Antibes 137
Veneta 133	Lorient 138
Sonett 134	Oslo 138
Clayton 135	Halden 138
Fey 135	Mara 139
Artus 135	Mila 139

1 Ceres / Serie 545
9545.01.06.0044
 EAN4003474298900
 Weiß / White

 1 x LED / 34 W incl.
 1 x 3000 lm

Energieeffizienzklasse /
 energy efficiency class:

A+

Markenleuchtmittel inkl.
 branded lamp incl.

Ø 53 cm, ↓ 13,5 cm

Glas / Glass: 1432



inkl. Farbtemperaturwechsler
 2800 - 5700 K /
 incl. colour temperature
 changer 2800 - 5700 K
 inkl. Nachtlicht und Schlafmodus
 incl. night light mode and sleep
 mode

IP23

LED Light
 by **WOFI**

SPA line
 by **WOFI**

Badleuchten - Licht für Körper und Seele

...Bathroom lighting - light
 for body and soul

Neu!

Neu!



2 Meran / Serie 245
9245.02.06.4044
 EAN4003474299570
 Weiß / White

 2 x E27 LED / 10 W incl.
 3000 K / 2 x 806 lm

Energieeffizienzklasse /
 energy efficiency class:

A+

Markenleuchtmittel inkl.
 branded lamp incl.

Ø 40 cm, ↓ 11 cm

IP20



34W

3000
 Lumen

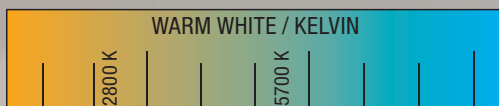

10W

806
 Lumen

3 Meran / Serie 245
9245.01.06.2644
 EAN4003474296098
 Weiß / White

 1 x E27 LED / 10 W incl.
 3000 K / 1 x 806 lm

Energieeffizienzklasse /
 energy efficiency class:

A+

Markenleuchtmittel inkl.
 branded lamp incl.

Ø 24,5 cm, ↓ 9 cm

IP20



SPA line
by WOFI®



LED Light
by WOFI®

6W
430
Lumen

1 Suri / Serie 622
4622.01.01.0044
EAN4003474296388
Chrom / Chrome

 1 x LED / 6 W incl.
3000 K / 1 x 430 lm

Energieeffizienzklasse /
energy efficiency class:

A+

Markenleuchtmittel inkl.
branded lamp incl.

Ø 10 cm, ↓ 3,5 cm, ⇨ 16,5 cm
IP44

4 Luce / Serie 502
4502.03.01.0044
EAN4003474296357
Chrom / Chrome

 3 x LED / 3,6 W incl.
3000 K / 3 x 300 lm

Energieeffizienzklasse /
energy efficiency class:

A+

Markenleuchtmittel inkl.
branded lamp incl.

↓ 11,5 cm, ⇨ 57 cm, ⇨ 12 cm
Glas / Glass: 1427, Ø 7,3 cm
IP23



2 Pax / Serie 621
4621.01.01.0044
EAN4003474296425
Chrom / Chrome

 1 x LED / 5 W incl.
3000 K / 1 x 340 lm

Energieeffizienzklasse /
energy efficiency class:

A+

Markenleuchtmittel inkl.
branded lamp incl.

↓ 3,5 cm, ⇨ 10 cm, ⇨ 16,5 cm
IP44

5W
340
Lumen

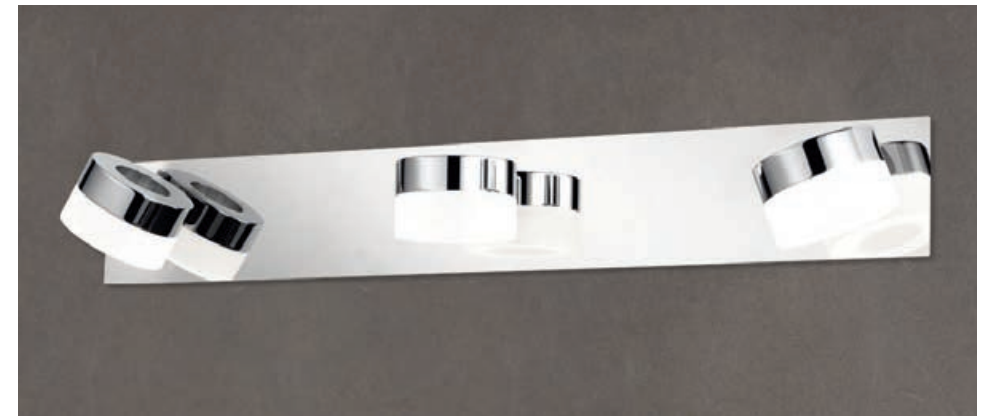

New!
New!

3 Veneta / Serie 871
9871.04.01.0044
EAN4003474296081
Chrom / Chrome

 4 x LED / 3 W incl.
3000 K / 4 x 210 lm

Energieeffizienzklasse /
energy efficiency class:

A+

Markenleuchtmittel inkl.
branded lamp incl.

↓ 25 cm, ⇨ 25 cm, ↓ 4 cm
IP20

3W
210
Lumen

5 Luce / Serie 502
9502.04.01.0044
EAN4003474296333
Chrom / Chrome

 4 x LED / 3,6 W incl.
3000 K / 4 x 300 lm

Energieeffizienzklasse /
energy efficiency class:

A+

Markenleuchtmittel inkl.
branded lamp incl.

↓ 26 cm, ⇨ 26 cm, ↓ 9 cm
Glas / Glass: 1427, Ø 7,3 cm
IP23



6 Luce / Serie 502
4502.01.01.0044
EAN4003474296340
Chrom / Chrome

 1 x LED / 3,6 W incl.
3000 K / 1 x 300 lm

Energieeffizienzklasse /
energy efficiency class:

A+

Markenleuchtmittel inkl.
branded lamp incl.

Ø 12 cm, ↗ 12 cm, ⇨ 12 cm
Glas / Glass: 1427, Ø 7,3 cm
IP23



3,6W
300
Lumen

LED Light
by WOFI®

4W
320
Lumen



1 Sonett / Serie 501
7501.03.01.0044
EAN4003474296302
Chrom / Chrome

3 x LED / 4 W incl.
3000 K / 3 x 320 lm

Energieeffizienzklasse /
energy efficiency class:

A+

Markenleuchtmittel inkl.
branded lamp incl.

↓ 10 cm, ↔ 55 cm, ⇨ 10 cm

Glas / Glass: 3059, ↔ 9 cm, ↓ 6 cm

IP23



2 Sonett / Serie 501
7501.02.01.0044
EAN4003474296296
Chrom / Chrome

2 x LED / 4 W incl.
3000 K / 2 x 320 lm

Energieeffizienzklasse /
energy efficiency class:

A+

Markenleuchtmittel inkl.
branded lamp incl.

↓ 10 cm, ↔ 35 cm, ⇨ 10 cm

Glas / Glass: 3059,
↔ 9 cm, ↓ 6 cm

IP23



3 Sonett / Serie 501
4501.01.01.0044
EAN4003474296289
Chrom / Chrome

1 x LED / 4 W incl.
3000 K / 1 x 320 lm

Energieeffizienzklasse /
energy efficiency class:

A+

Markenleuchtmittel inkl.
branded lamp incl.

↓ 9,5 cm, ↔ 15 cm, ⇨ 10 cm

Glas / Glass: 3059,
↔ 9 cm, ↓ 6 cm

IP23



LED-Badbeleuchten – Eine Investition für die Zukunft

...LED bathroom lighting – an investment in the future



4 Sonett / Serie 501
7501.04.01.0044
EAN4003474296319
Chrom / Chrome

4 x LED / 4 W incl.
3000 K / 4 x 320 lm

Energieeffizienzklasse /
energy efficiency class:

A+

Markenleuchtmittel inkl.
branded lamp incl.

↓ 10 cm, ↔ 75 cm, ⇨ 10 cm

Glas / Glass: 3059,
↔ 9 cm, ↓ 6 cm

IP23



1 Clayton / Serie 513
4513.01.01.0644
EAN4003474296401
Chrom / Chrome

1 x LED / 6 W incl.
3000 K / 1 x 430 lm

Energieeffizienzklasse /
energy efficiency class:
A+

Markenleuchtmittel inkl.
branded lamp incl.

↑ 4,5 cm, ↔ 62 cm, ⇨ 4 cm
IP44

6W
430 Lumen



2 Clayton / Serie 513
4513.01.01.0344
EAN4003474297811
Chrom / Chrome

1 x LED / 4,5 W incl.
3000 K / 1 x 320 lm

Energieeffizienzklasse /
energy efficiency class:
A+

Markenleuchtmittel inkl.
branded lamp incl.

↑ 4,5 cm, ↔ 35 cm, ⇨ 4 cm
IP44

4,5W
320 Lumen



3 Clayton / Serie 513
4513.01.01.0944
EAN4003474297828
Chrom / Chrome

1 x LED / 9 W incl.
3000 K / 1 x 640 lm

Energieeffizienzklasse /
energy efficiency class:
A

Markenleuchtmittel inkl.
branded lamp incl.

↑ 4,5 cm, ↔ 92 cm, ⇨ 4 cm
IP44

9W
640 Lumen

Neu!
Neu!



4 Fey / Serie 514
4514.01.01.0044
EAN4003474296418
Chrom / Chrome

1 x LED / 7 W incl.
3000 K / 1 x 500 lm

Energieeffizienzklasse /
energy efficiency class:
A

Markenleuchtmittel inkl.
branded lamp incl.

↑ 6,5 cm, ↔ 60 cm, ⇨ 8 cm

Steckdose /
electrical socket

IP44

7W
500 Lumen



5 Artus / Serie 623
4623.02.01.0044
EAN4003474296371
Chrom / Chrome

2 x LED / 3,6 W incl.
3000 K / 2 x 280 lm

Energieeffizienzklasse /
energy efficiency class:
A+

Markenleuchtmittel inkl.
branded lamp incl.

↑ 30,5 cm, ↔ 7 cm, ⇨ 12 cm

Glas / Glass: 1453,
Ø 5,5 cm, ↓ 13,5 cm
IP44

3,6W
280 Lumen

LED Light
by WOFI®



6 Artus / Serie 623
4623.01.01.0044
EAN4003474296364
Chrom / Chrome

1 x LED / 3,6 W incl.
3000 K / 1 x 280 lm

Energieeffizienzklasse /
energy efficiency class:
A+

Markenleuchtmittel inkl.
branded lamp incl.

↑ 18,5 cm, ↔ 7 cm, ⇨ 12 cm

Glas / Glass: 1453,
Ø 5,5 cm, ↓ 13,5 cm
IP44

3,6W
280 Lumen

LED Light
by **WOFI**



1 Midu / Serie 193
9193.03.01.0044
EAN4003474296241
Chrom / Chrome

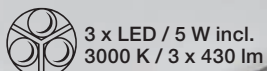

3 x LED / 5 W incl.
3000 K / 3 x 430 lm

Energieeffizienzklasse /
energy efficiency class:



Markenleuchtmittel inkl.
branded lamp incl.

Ø 43,5 cm, ↓ 14,5 cm

Glas / Glass: 6609,
↓ 8 cm, Ø 3,5 cm

IP20

2 Midu / Serie 193
9193.06.01.0044
EAN4003474296326
Chrom / Chrome



6 x LED / 5 W incl.
3000 K / 6 x 430 lm

Energieeffizienzklasse /
energy efficiency class:



Markenleuchtmittel inkl.
branded lamp incl.

Ø 45,5 cm, ↓ 14,5 cm

Glas / Glass: 6609, ↓ 8 cm, Ø 3,5 cm

IP20



5 Kent / Serie 060
9060.06.01.0044
EAN4003474296074
Chrom / Chrome



6 x LED / 5 W incl.
3000 K / 6 x 380 lm

Energieeffizienzklasse /
energy efficiency class:



Markenleuchtmittel inkl.
branded lamp incl.

Ø 25 cm, ↓ 16 cm, ↗ 25 cm

Glas / Glass: 1406,
↓ 9 cm, Ø 4 cm

IP20

Wohlfühlfaktor: Licht im Bad

...Feel good factor: light in the bathroom



SPA line
by **WOFI**

3 Midu / Serie 193
4193.01.01.0044
EAN4003474296234
Chrom / Chrome



1 x LED / 5 W incl.
3000 K / 1 x 430 lm

Energieeffizienzklasse /
energy efficiency class:



Markenleuchtmittel inkl.
branded lamp incl.

↓ 23 cm, ↗ 8,5 cm, ↘ 14 cm

Glas / Glass: 6609,
↓ 8 cm, Ø 3,5 cm

IP20

4 Oasis / Serie 500
4500.02.01.0044
EAN4003474296265
Chrom / Chrome



2 x LED / 5 W incl.
3000 K / 2 x 400 lm

Energieeffizienzklasse /
energy efficiency class:



Markenleuchtmittel inkl.
branded lamp incl.

↓ 32 cm, ↔ 10,5 cm, ↘ 8 cm

Glas / Glass: 3058,
↔ 12,5 cm, Ø 4,5 cm

IP44



6 Oasis / Serie 500
4500.01.01.0044
EAN4003474296258
Chrom / Chrome



1 x LED / 5 W incl.
3000 K / 1 x 400 lm

Energieeffizienzklasse /
energy efficiency class:



Markenleuchtmittel inkl.
branded lamp incl.

↓ 20,5 cm, ↔ 10,5 cm, ↘ 8 cm

Glas / Glass: 3058,
↔ 12,5 cm, Ø 4,5 cm

IP44



1 Maar / Serie 806
4806.01.01.0044
EAN4003474296180
Chrom / Chrome

1 x LED / 5 W incl.
3000 K / 1 x 400 lm

Energieeffizienzklasse /
energy efficiency class:
A+

Markenleuchtmittel inkl.
branded lamp incl.

Glas / Glass: 3054,
↓ 5,9 cm, Ø 5 cm

IP20

↔ 10 cm, ↗ 10 cm, ⊥ 15 cm

2 Maar / Serie 806
7806.03.01.0044
EAN4003474296203
Chrom / Chrome

3 x LED / 5 W incl.
3000 K / 3 x 400 lm

Energieeffizienzklasse /
energy efficiency class:
A+

Markenleuchtmittel inkl.
branded lamp incl.

↔ 45,5 cm, ↗ 7,5 cm, ⊥ 15 cm

Glas / Glass: 3054,
↓ 5,9 cm, Ø 5 cm

IP20

5W
400
Lumen

LED Light
by **WOFI**



6 Antibes / Serie 792
7792.06.01.0044
EAN4003474296111
Chrom / Chrome

6 x LED / 4 W incl.
3000 K / 6 x 400 lm

Energieeffizienzklasse /
energy efficiency class:
A+

Markenleuchtmittel inkl.
branded lamp incl.

↔ 60 cm, ↗ 8 cm, ⊥ 17 cm

Glas / Glass: 1386,
↓ 4,5 cm, Ø 5 cm

IP23

SPA line
by **WOFI**



3 Maar / Serie 806
9806.04.01.0044
EAN4003474296210
Chrom / Chrome

4 x LED / 5 W incl.
3000 K / 4 x 400 lm

Energieeffizienzklasse /
energy efficiency class:
A+

Markenleuchtmittel inkl.
branded lamp incl.

Glas / Glass: 3054,
↓ 5,9 cm, Ø 5 cm

IP20

↔ 25 cm, ↗ 25 cm, ⊥ 15 cm



4 Maar / Serie 806
7806.02.01.0044
EAN4003474296197
Chrom / Chrome

2 x LED / 5 W incl.
3000 K / 2 x 400 lm

Energieeffizienzklasse /
energy efficiency class:
A+

Markenleuchtmittel inkl.
branded lamp incl.

Glas / Glass: 3054,
↓ 5,9 cm, Ø 5 cm

IP20

↔ 32 cm, ↗ 7,5 cm, ⊥ 15 cm

4W
400
Lumen

5 Antibes / Serie 792
9792.06.01.0344
EAN4003474296128
Chrom / Chrome

6 x LED / 4 W incl.
3000 K / 6 x 400 lm

Energieeffizienzklasse /
energy efficiency class:
A+

Markenleuchtmittel inkl.
branded lamp incl.

Ø 34 cm, ⊥ 17 cm

Glas / Glass: 1386,
↓ 4,5 cm, Ø 5 cm

IP23



New!

New!

SPA *line*
by WOFI®

1 Lorient / Serie 848
7848.03.54.0044
EAN4003474296135
Nickel-matt / Chrom /
Nickel matt finished / Chrome

 3 x LED / 4 W incl.
3000 K / 3 x 400 lm

Energieeffizienzklasse /
energy efficiency class:

A+

Markenleuchtmittel inkl.
branded lamp incl.

↔ 36 cm, ↗ 9 cm, ⊥ 7,5 cm

Glas / Glass: 6620, Ø 3,4 cm, ⊥ 2,3 cm

IP23



↑
6620



2 Lorient / Serie 848
4848.01.54.0044
EAN4003474296272
Nickel-matt / Chrom /
Nickel matt finished / Chrome

 1 x LED / 4 W incl.
3000 K / 1 x 400 lm

Energieeffizienzklasse /
energy efficiency class:

A+

Markenleuchtmittel inkl.
branded lamp incl.

⊥ 11 cm, ↔ 11 cm, ⊥ 7 cm

Glas / Glass: 6620, Ø 3,4 cm, ⊥ 2,3 cm

IP23

LED Light
by WOFI®



Neu!
Neu!

4W

400
Lumen

3 Oslo / Serie 670
9670.01.63.3344
EAN4003474298887
Aluminium gebürstet /
Aluminium brushed finished



1 x LED / 20 W incl.
3000 K / 1 x 1600 lm

Energieeffizienzklasse /
energy efficiency class:

A

Markenleuchtmittel inkl.
branded lamp incl.

Ø 34,5 cm, ⊥ 9 cm

Glas / Glass: 1454

IP20

20W

1600
Lumen

4 Halden / Serie 672
9672.01.63.0344
EAN4003474298894
Aluminium gebürstet /
Aluminium brushed finished



1 x LED / 20 W incl.
3000 K / 1 x 1600 lm

Energieeffizienzklasse /
energy efficiency class:

A

Markenleuchtmittel inkl.
branded lamp incl.

⊥ 30 cm, ↔ 30 cm, ⊥ 9 cm

Glas / Glass: 1455

IP20



1 Mila / Serie 376
9376.01.64.3044
EAN4003474296708
Nickel-matt /
Nickel matt finished

 1 x LED / 10 W incl.
3000 K / 1 x 850 lm

Energieeffizienzklasse /
energy efficiency class:

A+

Markenleuchtmittel inkl.
branded lamp incl.

∟ 30 cm, ↔ 30 cm, ⊥ 10 cm

Glas / Glass: 1452

IP20

10W

850
Lumen

New!

New!



18,5W

1130
Lumen

2 Mara / Serie 876
9876.01.63.3344
EAN4003474296722
Aluminium gebürstet /
Aluminium brushed finished

 1 x LED / 18,5 W incl.
3000 K / 1 x 1130 lm

Energieeffizienzklasse /
energy efficiency class:

A

Markenleuchtmittel inkl.
branded lamp incl.

∅ 35 cm, ⊥ 10 cm

Glas / Glass: 1457

IP20

3 Mara / Serie 876
9876.01.63.2644
EAN4003474296715
Aluminium gebürstet /
Aluminium brushed finished

 1 x LED / 12,5 W incl.
3000 K / 1 x 730 lm

Energieeffizienzklasse /
energy efficiency class:

A

Markenleuchtmittel inkl.
branded lamp incl.

∅ 29 cm, ⊥ 9,5 cm

Glas / Glass: 1456

IP20



12,5W

730
Lumen



Outdoor *line*

Garantiert allwettertauglich

Unsere speziell entwickelten
Outdoor-Modelle holen die schönsten
Lichtstimmungen nach draußen.

Suitable for any weather

Our exterior lights are designed to set the per-
fect mood.

Newark	142
Austin	142
Brook	142
Brooklyn	143
Hall	143
Soho	143
Yard	144
Astoria	144
Sutter	145
Harris	145
Lua	146
Bronx	147

Outdoor line



1 Austin / Serie 945
4945.02.50.0000
EAN4003474297040
Grau / Grey

2 x LED / 6,8 W incl.
3000 K / 2 x 500 lm

Energieeffizienzklasse /
energy efficiency class:

A++ } L
A+ } E
A } D
B }
C }
D }
E }
Markenleuchtmittel inkl.
branded lamp incl.

↓ 13,5 cm, ↔ 11 cm, |→ 15,5 cm
IP54



2 Austin / Serie 945
4945.01.50.0000
EAN4003474297033
Grau / Grey

1 x LED / 6,8 W incl.
3000 K / 1 x 500 lm

Energieeffizienzklasse /
energy efficiency class:



Markenleuchtmittel inkl.
branded lamp incl.

↓ 12,5 cm, ↔ 11 cm, |→ 15,5 cm
IP54



5 Newark / Serie 819
3819.01.50.0500
EAN4003474296753
Grau / Grey

1 x LED / 9,5 W incl.
3000 K / 1 x 660 lm

Energieeffizienzklasse /
energy efficiency class:

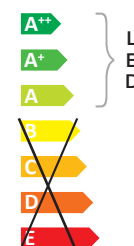

Markenleuchtmittel inkl.
branded lamp incl.

↓ 50 cm, ↔ 10,5 cm, |→ 15,5 cm
IP54



9,5W
660
Lumen

LED Light
by WOFI

3 Brook / Serie 952
4952.02.50.0000
EAN4003474296845
Grau / Grey

2 x LED / 2,5 W incl.
3000 K / 2 x 105 lm

Energieeffizienzklasse /
energy efficiency class:

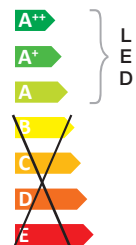

Markenleuchtmittel inkl.
branded lamp incl.

↓ 17,5 cm, ↔ 11 cm, |→ 7 cm
IP54



4 Newark / Serie 819
4819.01.50.0000
EAN4003474296739
Grau / Grey

1 x LED / 9,5 W incl.
3000 K / 1 x 660 lm

Energieeffizienzklasse /
energy efficiency class:



Markenleuchtmittel inkl.
branded lamp incl.

↓ 27,5 cm, ↔ 10 cm, |→ 17 cm
IP54



6 Newark / Serie 819
3819.01.50.0900
EAN4003474296746
Grau / Grey

1 x LED / 9,5 W incl.
3000 K / 1 x 660 lm

Energieeffizienzklasse /
energy efficiency class:

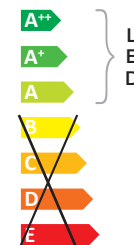

Markenleuchtmittel inkl.
branded lamp incl.

↓ 90 cm, ↔ 10,5 cm, |→ 15,5 cm
IP54

1 Brooklyn / Serie 830

4830.01.88.0000
EAN4003474297118
Anthrazit / Dark grey

1 x LED / 6 W incl.
3000 K / 1 x 430 lm

Energieeffizienzklasse /
energy efficiency class:



Markenleuchtmittel inkl.
branded lamp incl.

↑ 12 cm, ↔ 6 cm, ↗ 15 cm

Bewegungsmelder /
Motion Sensor

IP44

Outdoor line



6W
430
Lumen

LED Light

by **WOFI**

2 Brooklyn / Serie 830

3830.01.88.0400
EAN4003474297095
Anthrazit / Dark grey

1 x LED / 6 W incl.
3000 K / 1 x 430 lm

Energieeffizienzklasse /
energy efficiency class:



Markenleuchtmittel inkl.
branded lamp incl.

↑ 40 cm, ↔ 6 cm, ↗ 15 cm

Bewegungsmelder /
Motion Sensor

IP44



Neu!
New!



4 Soho / Serie 707

4707.01.50.0000
EAN4003474297484
Grau / Grey

1 x LED / 6,5 W incl.
3000 K / 1 x 220 lm

Energieeffizienzklasse /
energy efficiency class:



Markenleuchtmittel inkl.
branded lamp incl.

Ø 18 cm, ↗ 5,5 cm

IP54



6,5W
220
Lumen

5 Hall / Serie 706

4706.01.88.0000
EAN4003474297804
Anthrazit / Dark grey

1 x LED / 6,5 W incl.
3000 K / 1 x 320 lm

Energieeffizienzklasse /
energy efficiency class:



Markenleuchtmittel inkl.
branded lamp incl.

↑ 20 cm, ↔ 16 cm, ↗ 5 cm

inkl. Hausnummern:
3 x Nr. 0-9 / 1 x a-f
incl. house numbers:
3 x No. 0-9 / 1 x a-f

IP54



6,5W
320
Lumen

3 Brooklyn / Serie 830

3830.01.88.0850
EAN4003474297101
Anthrazit / Dark grey

1 x LED / 6 W incl.
3000 K / 1 x 430 lm

Energieeffizienzklasse /
energy efficiency class:

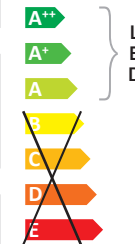

Markenleuchtmittel inkl.
branded lamp incl.

↑ 85 cm, ↔ 6 cm, ↗ 15 cm

Bewegungsmelder /
Motion Sensor

IP44



< 5 sec. - 9 min.



OFF ON
< 10 ~ 2000 Lux

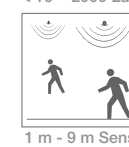

1 m - 9 m Sens

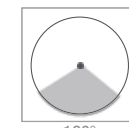

120°



0 - 9 m

6W
430
Lumen

LED Light
by **WOFI**

11W
600 Lumen



1 Astoria / Serie 703
4703.01.88.1300
EAN4003474296975
Anthrazit / Dark grey

 1 x LED / 11 W incl.
3000 K / 1 x 600 lm

Energieeffizienzklasse /
energy efficiency class:

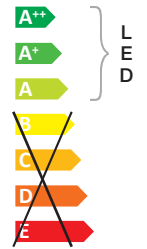

Markenleuchtmittel inkl.
branded lamp incl.

Ø 30 cm, |→ 9,5 cm

Glas / Glass: 1428, Ø 30 cm

IP44

9W
500 Lumen



2 Astoria / Serie 703
4703.01.88.1200
EAN4003474296968
Anthrazit / Dark grey

 1 x LED / 9 W incl.
3000 K / 1 x 500 lm

Energieeffizienzklasse /
energy efficiency class:

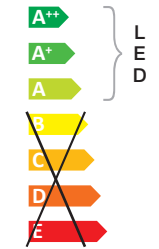

Markenleuchtmittel inkl.
branded lamp incl.

Ø 22 cm, |→ 6,5 cm

Glas / Glass: 1429, Ø 22 cm

IP44

Reine Formsache

...symbolizes the pure form

3 Yard / Serie 611
8611.01.06.0300
EAN4003474297132
Weiß / White
geeignet für / suitable for
Energieeffizienzklasse /
energy efficiency class:



  1 x E27 /
max. 23 W

Fit for LED

┌ 30 cm, ↔ 30 cm

IP65

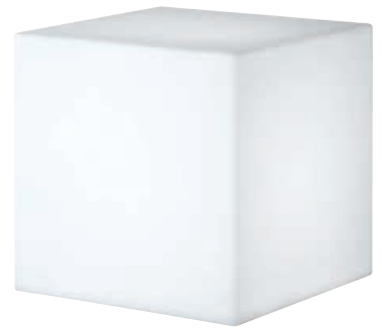

4 Yard / Serie 611
8611.01.06.0400
EAN4003474297149
Weiß / White
geeignet für / suitable for
Energieeffizienzklasse /
energy efficiency class:



  1 x E27 /
max. 23 W

Fit for LED

┌ 38 cm, ↔ 38 cm

IP65

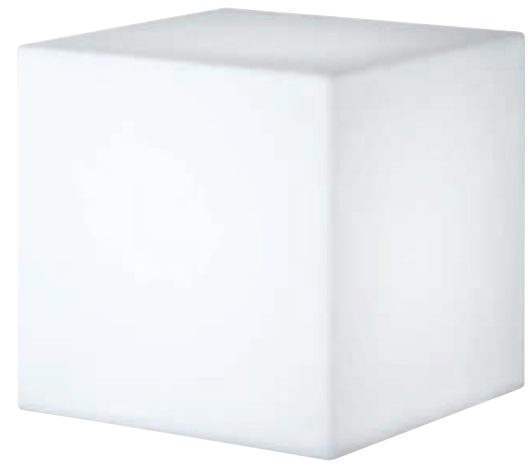

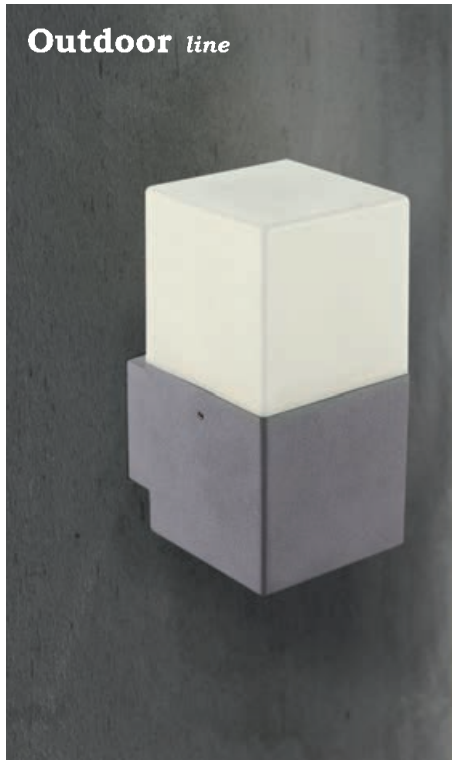

Outdoor line

1 Sutter / Serie 628
4628.01.50.0000
 EAN4003474297774
 Grau / Grey
 geeignet für / suitable for / Energieeffizienzklasse / energy efficiency class:



Fit for LED

↑ 17 cm, ↔ 8,5 cm, ⇨ 11,5 cm

Glas / Glass: 3055
 ↔ 8,5 cm, ↓ 8,5 cm

IP44

3 Sutter / Serie 628
3628.01.50.0300
 EAN4003474297743
 Grau / Grey
 geeignet für / suitable for / Energieeffizienzklasse / energy efficiency class:



Fit for LED

↑ 30 cm, ↔ 12 cm, ↗ 12 cm

Glas / Glass: 3055
 ↔ 8,5 cm, ↓ 8,5 cm

IP44

4 Sutter / Serie 628
3628.01.50.0600
 EAN4003474297750
 Grau / Grey
 geeignet für / suitable for / Energieeffizienzklasse / energy efficiency class:



Fit for LED

↑ 50 cm, ↔ 12 cm, ↗ 12 cm

Glas / Glass: 3055
 ↔ 8,5 cm, ↓ 8,5 cm

IP44

5 Sutter / Serie 628
3628.01.50.0900
 EAN4003474297767
 Grau / Grey
 geeignet für / suitable for / Energieeffizienzklasse / energy efficiency class:



Fit for LED

↑ 70 cm, ↔ 12 cm, ↗ 12 cm

Glas / Glass: 3055
 ↔ 8,5 cm, ↓ 8,5 cm

IP44



LED Light
 by WOFI®



2 Harris / Serie 805
4805.02.63.0000
 EAN4003474297354
 Aluminium gebürstet /
 Aluminium brushed finished



Energieeffizienzklasse /
 energy efficiency class:



Markenleuchtmittel inkl.
 branded lamp incl.

↑ 16 cm, ↔ 7,5 cm, ⇨ 10 cm

IP54





LUA Outdoorleuchten

- Leuchten aus opalweißem und bruchsicherem (PE) Kunststoff
- Glatte Oberfläche, dadurch:
- UV- und Wärmestabil, Wetterfest, unempfindlich gegenüber Schmutz
- Temperaturbeständig -40°C bis +70°C
- 5 Meter lange Gummileitung inkl. Netzstecker
- Schutzklasse 2, Schutzisoliert
- Schutzart IP67, Wasserdicht
- Bestückbar mit Allgebrauchslampen E27
- Lieferung mit beiliegendem Erdspeiß
- Lieferung ohne Leuchtmittel

LUA Outdoor lamps

- opal white and break-proofed plastic (PE)
- plane surface for less sediment
- UV- and heat-stabilised
- temperature-resistant from -40°C to +70°C
- 5 m rubber cable with shaped plug
- protection class 2
- IP67
- E27 GLS socket (bulb excl.)
- spike included

Eine runde und gelungene Erscheinung
 ...A round and successful appearance

Outdoor line

1 Lua / Serie 308
8308.01.06.0300
 EAN4003474179186
 Weiß / White
 geeignet für / suitable for /
 Energieeffizienzklasse /
 energy efficiency class:



1 x E27 /
 max. 25 W

Fit for LED

Ø 30 cm

2 Lua / Serie 308
8308.01.06.0400
 EAN4003474179193
 Weiß / White

geeignet für / suitable for /
 Energieeffizienzklasse /
 energy efficiency class



1 x E27 /
 max. 60 W

Fit for LED

Ø 40 cm

3 Lua / Serie 308
8308.01.06.0500
 EAN4003474179209
 Weiß / White

geeignet für / suitable for /
 Energieeffizienzklasse /
 energy efficiency class



1 x E27 /
 max. 60 W

Fit for LED

Ø 50 cm

Outdoor line



1 Bronx / Serie 802
1802.01.97.0050
 EAN4003474296791
 Edelstahl gebürstet /
 Stainless steel brushed

 1 x LED / 8 W incl.
 3000 K / 1 x 480 lm

Energieeffizienzklasse /
 energy efficiency class:

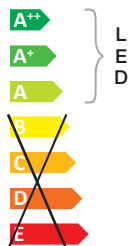

Markenleuchtmittel inkl.
 branded lamp incl.

Ø 15,8 cm, ↓ 9,2 cm

IP67



8W

480
 Lumen



50°

LED Light
 by **WOFI**



5W

350
 Lumen

2 Bronx / Serie 802
8802.01.97.0000
 EAN4003474296814
 Edelstahl gebürstet /
 Stainless steel brushed

 1 x GU10 LED / 5 W incl.
 3500 K / 1 x 350 lm

Energieeffizienzklasse /
 energy efficiency class:

A+

Markenleuchtmittel inkl.
 branded lamp incl.

↓ 32 cm, ↳ 6 cm

IP44

3 Bronx / Serie 802
1802.01.97.0100
 EAN4003474296807
 Edelstahl gebürstet /
 Stainless steel brushed

 1 x LED / 4 W incl.
 3000 K / 1 x 240 lm

Energieeffizienzklasse /
 energy efficiency class:

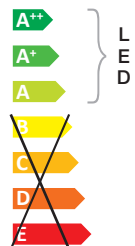

Markenleuchtmittel inkl.
 branded lamp incl.

Ø 12 cm, ↓ 7,1 cm

IP67



4W

240
 Lumen



50°

Neu!
Neu!

UNSER AUSSENDIENST

OUR SALES REPRESENTATIVES



NORDDEUTSCHLAND

JENS GEBERS
Löwenzahnstr. 13
D - 29643 Neuenkirchen

Phone 05195 / 453
Fax 05195 / 437
Mobile 0171 / 6938950
Email Jens.Gebers@wofi.de



WESTDEUTSCHLAND

FRITZ BLOME
Wintrop 19
D - 59846 Sundern-Dörnholthausen

Phone 02933 / 2316
Fax 02933 / 77126
Mobile 0171 / 4178100
Email Fritz.Blome@wofi.de



SÜD-WESTDEUTSCHLAND

DIETMAR BERTUS
Neustr. 12
D - 56237 Deesen

Phone 02626 / 923728
Fax 02626 / 924650
Mobile 0171 / 6236008
Email Dietmar.Bertus@wofi.de



AUSTRIA

HERMANN THONHAUSER
Franz Weigand Weg 18
A- 9431 St. Stefan

Fax + 49 (0) 2903 / 449 48 133
Mobile + 43 (0) 664 / 4 05 09 55
Email hermann.thonhauser@wofi.de



BELGIUM LUXEMBOURG

DIRK FRANCK
Light Things Benelux
LT Coppens / Ruiterschool 14
B-2930 Brasschaat

Phone + 32 3 455 93 59
Fax + 32 3 455 33 59
Email info@lightthings.be

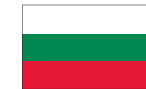

BULGARIA

ALEXANDER MISHEV
Wofi jsc
39 Industrialna
Primo Center, 1/F
BG-8000 Burgas

Phone + 359 895 30 40 40
Email a.mishev@wofi.de



SÜDDEUTSCHLAND BADEN-WÜRTTEMBERG

THOMAS KRAUSS
Mühlbachstr. 36
D - 88662 Überlingen

Phone 07551 / 838765
Fax 07551 / 972787
Mobile 0171 / 8010777
Email Thomas.Krauss@wofi.de



SÜDDEUTSCHLAND BAYERN

MAXIMILIAN REINER
CHRISTIAN HUBER
Arbeostr. 5a
D - 85386 Eching

Phone 089 / 3195766-65
Fax 089 / 3195764
Mobile 0172 / 9310554 (M. Reiner)
Mobile 0172 / 9310555 (C. Huber)
Email Maximilian.Reiner@wofi.de



CROATIA / SLOVENIA / BOSNIA-HERZEGOVINA

ZELJKO CONDRCIC
Management Service
Billrothstr. 2/42
A-1190 Wien

Mobile + 385 9 17 89 06 69
Email condric-rev@hotmail.de



FRANCE

XAVIER LIEBL
LX France Sarl
119 Rue Grenette
F-69400 Villefranche-Sur-Saône

Est / Rhone Alpes / Centre / Sud-Est:

Phone + 33 (0) 4 69 17 60 01

Ouest / Sud-Ouest:

Phone + 33 (0) 4 69 17 60 02

Paris / Nord:

Phone + 33 (0) 4 69 17 60 03

Centrales d'Achats:

Phone + 33 (0) 4 69 17 60 04

Fax + 33 (0) 4 74 09 99 27

Email wofi@lxfrance.com



CZECHIA / SLOVAKIA

RADEK MOTYKA
AULIX Lighting s.r.o.
U Náměstí 708
CZ-25241 Dolní Břežany
(Praha západ)

Phone + 420 241 402 565
Mobile + 420 702 053 063
Email info@aulix.cz
Web www.aulix.cz



DENMARK / NORWAY

KRISTEN BYRHOLT DARØ
KBD Nordic
Ketting Parkvej 53
DK-8462 Harlev J

Mobile + 45 7120 1420
Email kd@wofi.dk



OSTDEUTSCHLAND

JÜRGEN RUSCHER
Ferdinand-Schumann-Str. 10
D - 08141 Reinsdorf

Fax 0375 / 3909952
Mobile 0171 / 6236005
Email Juergen.Ruscher@wofi.de



OSTDEUTSCHLAND

UDO SCHMIDT
Schillerstr. 12
D - 01454 Radeberg

Fax 03528 / 446212
Mobile 0171 / 6236017
Email Udo.Schmidt@wofi.de



GREAT BRITAIN / IRELAND

IAN DORMER
Luminess Ltd.
17 Wye Estate, London Road
High Wycombe
HP11 1LH, UK

Phone + 44 (0) 14 94 44 22 64
Email office@luminess-ltd.co.uk
www.luminess-ltd.co.uk



HUNGARY

TIBOR UNTERBERGER

Hetven Barack KFT
Barackvirág u. 70
H-2000 Szentendre

Phone + 36 26 31 59 07

Fax + 36 26 31 59 07

Mobile + 36 30 93 17 226

Email utibor@mail.datanet.hu



ITALY

VINCENZA SCACCIAFERRO

Fhc srl
Via Stazione 94
I-26013 Crema (CR)

Phone + 39 0 373 20 48 39

Fax + 39 0 373 20 48 45

Email

vincenza.scacciaferro@teamwings.com



MALTA

SYLVAN MICALLEF

MF Electrix
245, S.Psaila
MT-B'Kara BKR9078

Phone + 356 214 949-55/-56

Fax + 356 214 949 57

Mobile + 356 99498316

Email info@mfelectrix.com.mt
www.mfelectrix.com.mt



SWEDEN

PETTER BORNARVE

More Trade Syd AB
Metallgatan 17 A
SE-26272 Ängelholm

Phone + 46 721 681 466

Email p.bornarve@m-trade.se

Web www.m-trade.se



SWITZERLAND

BORIS SCHÖNENBERGER

Mondilux AG
Gewerbstraße 12
CH-4450 Sissach

Phone + 41 (61) 9 76 92 00

Fax + 41 (61) 9 76 92 10

Email info@mondilux.ch



NETHERLANDS

DIRK FRANCK

Light Things BeNeLux
LT Coppens / Ruiterijschool 14
B-2930 Brasschaat

Phone + 32 3 455 93 59

Fax + 32 3 455 33 59

Email info@lightthings.be



POLAND

RAFAL FLISZEWSKI

WOFI Polska s.c.
ul. E.Orzeszkowej 4
PL-86-032 Niemcz

Phone + 48 52 32 00 319

Fax + 48 52 55 29 664

Mobile + 48 606 488 226

Email rafal.fliszewski@wofipolska.pl



PORTUGAL

NUNO SANTOS

Candilamp Iluminação
e Decoração Lda
Av. Engº Duarte Pacheco, 67
P-8315-104 Almancil

Phone + 351 289 39 10 73

Fax + 351 289 39 10 74

Mobile + 351 962 32 78 78

Web wofi@candilamp.pt



TURKEY

DR. STEPHANIE LEMPA

WOFI Deutschland
Im Langel 6
D-59872 Meschede

Phone + 49 2903 449 198

Fax + 49 2903 449 180

Email stephanie.lempe@wofi.de



UKRAINE

VALERIY KOPP

PPU Furmann
Uliza 600 - Letija 36
UA-21021 Winnyzja

Phone + 38 (0) 4 32 56 00 18

Fax + 38 (0) 4 32 56 00 18

Mobile + 38 (0) 9 67 00 99 66

Email info@wofi.com.ua



PORTUGAL

PAULO PINHEIRO

DISLAMP-Artigos de Iluminação, Lda
Rua do Covão 27
Zona Industrial do Covão
P-3750-881 Águeda

Phone + 351 234 64 41 48

Fax + 351 234 64 43 34

Email dislamp@dislamp.pt



ROMANIA

IONUT CHITULESCU

Prevederii, Nr. 13A, BL M1C, AP 135
RO-032294 Bucuresti, Sector 3

Mobile + 40 7305 125 14

Email ionut.chitulescu@gmail.com



SPAIN

JOSÉ MANUEL GOLVANO

Mobile + 34 670854557
Email wofi@decoluz21.es

JOSÉ LUIS GÓMEZ

Mobile + 34 609014120

Email wofi.jgomez@icloud.com



EUROPA

Für alle anderen, nicht aufgeführten Länder
kontaktieren Sie bitte:

For all the other countries please contact:

WOFI DEUTSCHLAND

GEORG ECKHARDT

D-59872 Meschede

Phone + 49 2903 / 449162

Fax + 49 2903 / 449180

Email georg.eckhardt@wofi.de

ALLGEMEINE INFORMATIONEN

QUALITÄT UND SICHERHEIT

WOFI-LEUCHTEN werden nach der aktuellen Norm EN60598 entwickelt und gefertigt. WOFI hat ein Qualitätssicherungssystem (TQM). Die diesbezüglichen Prozesse sind unter anderem in einem Ablaufdiagramm definiert.

Alle Leuchten und Bauteile, Bearbeitungs- und Veredelungsverfahren, sowie deren Auszeichnungen, entsprechen ausschließlich den aktuellsten Normen und Regelwerken für den europäischen Binnenmarkt:

- Produktsicherheitsgesetz (ProdSG) vom 08.11.2011
- Niederspannungsrichtlinie 2006/95/EG
- Elektromagnetische Verträglichkeit EMV 2004/108/EG
- Elektro- und Elektronik-Altgeräte WEEE 2012/19/EU
- EG-Richtlinie 2011/65/EU zur Beschränkung der Verwendung bestimmter gefährlicher Stoffe in Elektrogeräten (RoHS 2)
- Ökodesign-Richtlinie 2009/125/EG
- Anforderungen an die umweltgerechte Gestaltung energieverbrauchsrelevanter Produkte (ErP)
- Anforderungen an die umweltgerechte Gestaltung von Haushaltslampen mit unbündeltem Licht (244/2009/EG) und von Lampen mit gebündeltem Licht, LED Lampen und dazugehörigen Geräten (1194/2012/EU).

Die Leuchten sind transportsicher und umweltfreundlich in Wellpappkartonagen verpackt. In unseren Laboratorien werden regelmäßig Prüfungen bezüglich Funktion und Sicherheit sowie bei Leuchtmitteln Lebensdauerprüfungen durchgeführt. Sollte dennoch ein Fehler auftreten, setzen Sie sich bitte umgehend mit Ihrem Fachhändler oder direkt mit unserer Serviceabteilung in Verbindung.

TRANSFORMATOREN

1. Ringkerntransformatoren

Der Eisenkern ist als Ring aufgebaut, um den dann die Kupferspulen gewickelt werden.

Hinweis: Bei ungedimmten und besonders bei gedimmten Transformatoren kann ein leichtes Brummgeräusch nicht ausgeschlossen werden.

2. Elektronische Transformatoren

Diese so genannten Schaltnetzteile bieten eine lastunabhängige Sekundärspannung, einen Lampenschonenden Softstart, Überlast- und Kurzschlusschutz, kleinste Bauformen, keine Brummgeräusche.

DIMMEN VON LEUCHTEN MIT EINGEBAUTEM TRANSFORMATOR

Für jeden Transformator gibt es einen entsprechenden Dimmer:

1. Block- und Ringkerntransformatoren

Diese Transformatoren werden nach dem Phasenanschnittprinzip gedimmt. Sie benötigen zum Dimmen einen Dimmer für Eisenkern-Transformatoren. Wir empfehlen Ihnen z.B. den Dimmer Typ 2247 Fabrikat Busch-Jäger.

2. Elektronische Transformatoren

Elektronische Transformatoren werden nach dem Phasenabschnittprinzip gedimmt. Sie benötigen zum Dimmen einen Dimmer für elektronische Transformatoren. Wir empfehlen Ihnen z.B. den Dimmer Typ 6513 Fabrikat Busch-Jäger.

LEUCHTMITTEL/LAMPEN – LICHT-/LAMPENTECHNOLOGIE

Es gibt verschiedene Möglichkeiten der Lichterzeugung, unterschiedliche Prinzipien und Nutzung verschiedener Medien. Daraus und aus lichttechnischen Entwicklungen, ergeben sich Aspekte zur Charakterisierung einer Lampe bzw. Lichtquelle. Dazu gehören sowohl Eigenschaften der Lichtqualität wie Lichtfarbe, Farbwiedergabe und die spektrale Zusammensetzung, aber auch die elektrische Leistung (W), die mittlere Lebensdauer (h), die Lichtleistung/Lichtstrom (Lumen) und die Beleuchtungsstärke (Lux). Hinzu kommen Aspekte, die für den Einsatz in speziellen Umgebungen wichtig sein können (z.B. UV-Emission, Wärmeabstrahlung, Umgebungstemperatur) und äußere Merkmale wie Lampenform, Sockelart und Baugröße. Nicht zu vernachlässigen sind ökonomische Faktoren wie Preis bzw. Preis-Leistungs-Verhältnis und die Umweltverträglichkeit.

Im Folgenden wird ein Einblick in die von WOFI-LEUCHTEN eingesetzten Lampentypen und deren wesentlichen Eigenschaften gegeben.

1. Glühlampen

Glühlampen erzeugen Licht, indem sie mit elektrischem Strom einen Wolframdraht zum Glühen bringen. Dabei wird Energie über einen weiten homogenen Wellenbereich ausgestrahlt, ähnlich der spektralen Verteilung des Tageslichtes im sichtbaren Bereich.

→ Klassische Glühlampe

Die klassische Glühlampe setzt den Großteil der zugeführten Energie in Wärme um (96%) und nur einen geringen Anteil in Licht. Sie gehört zu den Temperaturstrahlern. Das erzeugte Licht ist ein sehr angenehmes und warmes Licht, bei sehr guter Farbwiedergabe (1A). Durch die Zugabe von Edelgasen (Argon und Krypton) kann die Lichtausbeute und die Lebensdauer erhöht werden. Die Sockelform E14 bzw. E27 ermöglicht ein breites Sortiment verschiedener Typen. Allgebrauchs-Glühlampen haben eine mittlere Lebensdauer von ca. 1.000 h. Spannungsspitzen führen zu frühzeitiger Zerstörung. Dimmen hingegen kann die Lebensdauer verlängern.

→ Halogen-Glühlampe

Die Zugabe von Halogenen verhindert das Verdampfen von Wolfram und somit eine Kolbenschwärzung. Es wird eine hohe und konstante Lichtausbeute erzielt. Dadurch entsteht ein brillantes Licht bei sehr guter Farbwiedergabe (1A). Die störende UV-Emission, die z.B. das Ausbleichen von Farben beschleunigt, kann durch entsprechende UV-Filter vermieden werden. Der Lampenkolben ist aus Quarzglas, um gegen die Halogene resistent zu sein. Die Lebens-

dauer der Halogenleuchtstofflampen ist je nach Typ sehr unterschiedlich. Dimmen erhöht die Lebensdauer. Die verschiedenen Typen unterscheiden sich auch in der Sockelform, was beim Lampenwechsel beachtet werden muss.

Man unterscheidet:

(A) Hochvolt-Halogen-Glühlampe

Hochvolt-Halogen-Glühlampen werden direkt mit Netzspannung versorgt. Sie sind aufwendig herzustellen, erreichen je nach Typ Leistungsaufnahmen bis 500 W und eine Lebensdauer bis 2.000 h.

(B) Niedervolt-Halogen-Glühlampe

Niedervolt-Halogen-Glühlampen benötigen einen Transformator (Umwandlung der Netzspannung in Schutzkleinspannung, in der Regel 12V). Niedervolt-Halogen-Glühlampen haben sehr kleine Abmessungen. Die kleinen Wendel und entsprechende Reflektoren bewirken eine gerichtete effiziente Lichtlenkung. Die maximale Leistung beträgt 100W, die mittlere Lebensdauer je nach Typ ca. 2.000 h bis 4.000 h.

→ IRC-Technologie (Infra-Red-Coating)

Eine spezielle Beschichtung des Lampenkolbens reflektiert die erzeugte Wärme zurück auf die Glühwendel, um diese auf Betriebstemperatur zu halten. Das Ergebnis ist eine um ca. 30% höhere Lichtausbeute und damit eine entsprechende Energieeinsparung. Die IRC-Technologie wird sowohl bei Hoch- als auch bei Niedervoltlampen eingesetzt.

2. Leuchtstofflampen

Leuchtstofflampen sind Gasentladungslampen in Niederdrucktechnik. Für den Betrieb ist ein Vorschaltgerät notwendig. Der zylindrische Glaskolben ist mit einem Gasgemisch gefüllt. An den Enden sind jeweils Elektroden. Bei angelegter Spannung emittiert das Gasgemisch ultraviolettes Licht, das an der Innenseite des Glaskolbens durch dort aufgebrauchte Leuchtstoffe in sichtbares Licht umgewandelt wird. Die Mischung und Qualität dieser Beschichtung ist entscheidend für die Lichtfarbe und Farbwiedergabe (1A, 1B) der Leuchtstofflampe. Leuchtstofflampen zeichnen sich durch einen geringen Stromverbrauch bei hoher Lichtleistung und eine lange Lebensdauer aus. Dabei wird kaum Wärme erzeugt. Negative Bewertungen des Leuchtstofflampenlichtes, wie z.B. Brummen und Flackern, unnatürliche Farben und ungemütliche Wirkung sind mit moderner Technik und bei richtiger Auswahl des Leuchtmittels nicht festzustellen.

Hinweis: Leuchtstofflampen gehören nicht in den Hausmüll, sondern ins Recycling der kommunalen Sammelstelle.

→ Leuchtstofflampe in Stabform

Die unterschiedlichen Bezeichnungen resultieren aus den verschiedenen Bauformen und Abmessungen. Ausschlaggebend für die Bezeichnung ist der Glaskolbendurchmesser in Millimeter bzw. Zoll, z.B. T26 bzw. T8, T16 bzw. T5

Leuchtstofflampen benötigen Vorschaltgeräte, elektronische bzw. verlustarme magnetische Geräte kommen bei T8 Lampen zum Einsatz. T5 Lampen sind ausschließlich mit elektronischen Vorschaltgeräten zu betreiben, mit u. a. folgenden Vorteilen: erhöhte Lebensdauer und Lichtausbeute um ca. 25%, flackerfreier Sofortstart und flimmerfreier Betrieb, sowie Abschalten bei Fehlfunktion. Auch häufiges Ein- und Ausschalten wirkt sich nicht negativ aus. Die mittlere Lebensdauer liegt bei 12.000 h, T5 bis 20.000 h. Für den Dimmereinsatz sind spezielle Elektronik erforderlich, das Dimmen erfolgt farb stabil, also ohne Änderung der spektralen Strahlungskurve.

Eine Sonderform stellen die Leuchtstofflampen in Ringform dar, die flache Leuchtenformen mit rotations-symmetrischer Lichtverteilung ermöglichen.

→ Kompakte Leuchtstofflampe (Energiesparlampe ESL)

Sie haben, dem Namen entsprechend, eine kompakte Bauform, bei einer Vielfalt von Abmessungen, Leistungsstufen sowie Glaskolben- und Sockelformen. Die Farbwiedergabe ist mit 1B als gut zu bewerten, die Lebensdauer reicht je nach Typ von 6.000 h bis 15.000 h. Vor allem die Energiesparlampen (ESL) mit integriertem Vorschaltgerät und einem herkömmlichen Schraubsockel (E14, E27) verdrängen trotz höherer Investitionskosten immer mehr die Glühlampe aus dem energiebewussten Haushalt.

3. LED (Licht Emittierende Diode)

LED (Leuchtdioden) sind Halbleiterdioden und gehören zu den Elektrolumineszenz-Strahlern. Durch die Steigerung der Effizienz und der Entwicklung weißer LEDs ist der Einsatz der Leuchtdioden auch auf dem Gebiet der Beleuchtung möglich geworden.

LED basieren auf Halbleiterverbindungen, die den Strom direkt in Licht umwandeln. Bezogen auf Größe, Effektivität, Haltbarkeit und Lebensdauer verhalten sich die Leuchtdioden zu konventionellen Glühlampen wie Halbleiterdioden zu Röhrendioden. Sie werden die Beleuchtungstechnik in ähnlicher Weise verändern wie die Halbleitertechnologie schon die Elektronik verändert hat.

Mittels LED werden zukünftig WOFI-LEUCHTEN realisiert, die in ihrer Form, Lichtwirkung, Regelbarkeit und anderen Eigenschaften völlig neuartig sind. Es lassen sich gerichtete Licht abgebende, zwei- oder dreidimensional flächige oder lineare Leuchten mit beliebiger Kontur realisieren. Jede LED gibt gerichtete Licht ab. Die Lichtfarbe ist bei Einsatz farbiger LED regelbar. Die Farbwiedergabe von LED-Licht kann durch mehrere Spektralbereiche zu 1A zusammengesetzt werden.

Lichtfarbe in Kelvin ERKLÄRUNG LICHTTECHNISCHER BEGRIFFE

Lumen
Der Lichtstrom (Lumen; lm) ist die von einer Lichtquelle in alle Richtungen ausgestrahlte und nach der international festgelegten Augenempfindlichkeit bewertete Strahlungsleistung. Die Werte für den Lichtstrom der Lichtquelle sind in den Produktlisten der Lampenhersteller angegeben.

Lux
Die Beleuchtungsstärke (Lux; lx) gibt an, wie viel Licht auf eine Flächeneinheit fällt. Die für künstliche Beleuchtung erforderlichen Beleuchtungsstärken sind in DIN-Normblättern angegeben.

Lichtausbeute
Die Lichtausbeute ist das Maß für die Wirtschaftlichkeit einer Lichtquelle. Sie sagt aus, wie viel Lumen pro Watt aus einer Lampe herauskommen. Je höher das Verhältnis Lumen/Watt (lm/W), desto wirtschaftlicher ist die Lichtquelle.

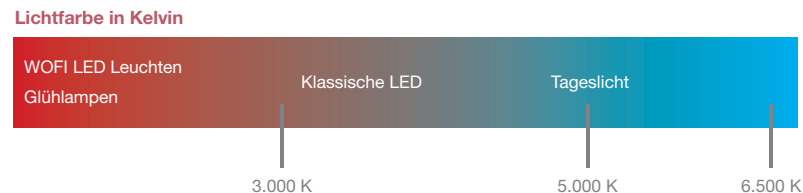
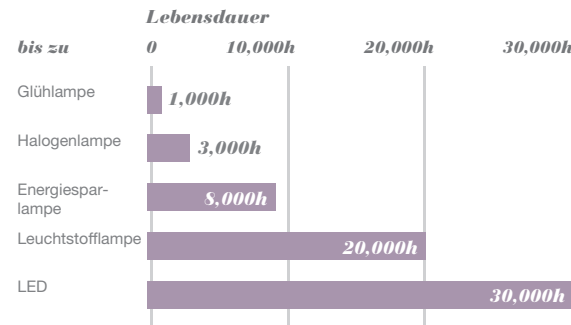
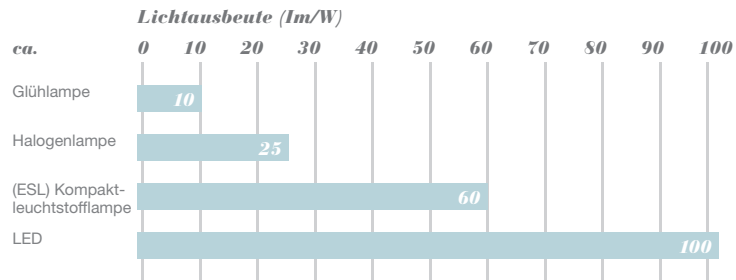

Folgende Dimmer sind für den Einsatz bei unseren Pendelleuchten geeignet

Hersteller	Dimmer Bestellnummer	Beschreibung
Berker	286710	Tronic Drehdimmer 20-360W
GIRA	0307 00	Tronic Dimmer-Einsatz 20-525W
Jung	225TDE	Tronic Drehdimmer 20-525W
Peha	433HAB-60	Tronic Drehdimmer; Phasenabschnitt 20-250W
Siemens	5 TC8 284	NV-Dimmer-Einsatz für elektr. Trafos 20-525VA

Lichtfarbe
Die Lichtfarbe einer Lampe wird charakterisiert mit dem Begriff der „Farbtemperatur“, angegeben in der Temperatur-Maßeinheit Kelvin (K). Eine Glühlampe mit ihrem warmweißen Licht hat z.B. eine Farbtemperatur von 2700 K, eine hellweiße Leuchtstofflampe eine Farbtemperatur von 4000 K und eine tageslichtähnliche Leuchtstofflampe 5000 K.

GLÄSER

Mundgeblasene Gläser
Bei mundgeblasenen Gläsern handelt es sich um frei geformte Gläser – keine industrielle Fertigung. Somit ist jedes Glas ein Unikat. Kleine Luft einschüsse im Glas sind daher kein Reklamationsgrund, sondern ein Merkmal für handwerkliche Glaskunst.

SCHUTZBEREICHE FÜR DIE ANWENDUNG VON LEUCHTEN IM BADEZIMMER

Badezimmer sind Feuchträume. Wo Elektrizität und Feuchtigkeit zusammentreffen, ist besondere Vorsicht geboten. Im Interesse der Sicherheit gibt es deshalb spezielle Vorschriften, um Gefahren und Unfälle zu vermeiden. Drei so genannte Schutzbereiche für Badezimmer sind in der Norm DIN VDE 0100 Teil 701 festgelegt.

Schutzbereich 0
Er umfasst den unmittelbaren Innenraum der Bade- oder Duschwanne, beispielsweise bei Einsatz von

Unterwasserleuchten. Dabei dürfen ausschließlich Betriebsmittel mit Schutzkleinspannung bis maximal 12 Volt eingesetzt werden, welche ausdrücklich für die Installation im Wanninnenbereich zugelassen sind. Sie müssen mindestens in der Schutzart IP X7 eingestuft sein. Schutzkleinspannung bedeutet, dass ein Stromkreis mit geringer Spannung von Stromkreisen höhere Spannung gespeist wird, von diesen aber sicher getrennt sein muss.

Schutzbereich 1

Er umschreibt eine Fläche innerhalb der senkrechten Begrenzungen von Wanne oder Dusche. Ist keine Duschwanne vorhanden, gilt der Radius von 120 Zentimetern rund um den Brausekopf in Ruhelage. Die untere Begrenzung ist der Fußboden, nach oben hin wird eine waagerechte Fläche in 2,25 Metern Höhe über dem Fußboden angenommen. Auch im Schutzbereich 1 dürfen nur Leuchten mit Schutzkleinspannung bis maximal 12 Volt zum Einsatz kommen. In den Bereichen 1 und 0 dürfen sich keine Transformatoren befinden.

Schutzbereich 2

Er grenzt an Bereich 1 mit einer Tiefe von 60 Zentimetern an. In den Bereichen 1 und 2 müssen Leuchten mindestens in die Schutzart IP X4 eingestuft sein, bei Geräten mit Strahlwasser, beispielsweise Massagedrüsen, ist die Schutzart IP X5 erforderlich.

Duschen oder Wannen besitzen generell nur den Schutzbereich 1. Im sonstigen Raum gelten keine besonderen Schutzbestimmungen. Steckdosen und Schalter sind in den Bereichen 0, 1 und 2 nicht zulässig. Sofern sie die

Schutzart nicht herabsetzen, sind allerdings in Leuchten eingebaute Schalter zugelassen. Mantelleitungen zu Leuchten dürfen über und unter Putz verlegt werden, Stegleitungen lediglich unter Putz mit einer Tiefe von mindestens sechs Zentimetern.

Unter Schutzart versteht man die Einstufung der Betriebssicherheit von Leuchten. Sie wird im IP-Code (Ingress Protection) angegeben, der zwei Kennziffern trägt. Wird eine der beiden Kennziffern nicht angegeben, so steht dafür ein X. Während die erste Kennziffer sich auf die Widerstandsfähigkeit gegen Festkörper und Staub bezieht, ist für Badleuchten vor allem die zweite Ziffer von Belang. Hierbei geht es um das Verhältnis von Wasser und Feuchtigkeit.

Des Weiteren werden für Leuchten drei Schutzklassen unterschieden, welche den Umfang von Vorkehrungen gegen elektrischen Schlag darstellen:

Schutzklasse I

Leuchten für den Anschluss an den netzseitigen Schutzleiter.

Schutzklasse II

Leuchten mit einer zusätzlichen oder verstärkten Isolierung ohne Schutzleiteranschluss.

Schutzklasse III

Leuchten für den Betrieb mit Schutzkleinspannung.

SCHEMATISCHE DARSTELLUNG DER SCHUTZBEREICHE FÜR WANNEN UND DUSCHEN JEWEILS MIT UND OHNE FEST EINGebaUTE TRENNWAND

Wannen:

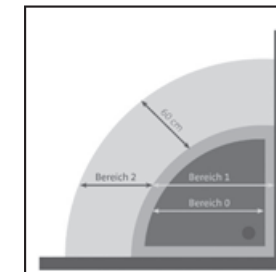

• Feste Wasseraustrittsstelle

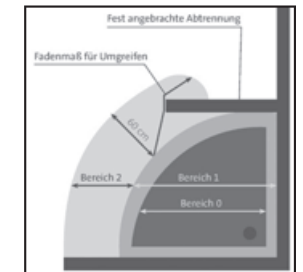

Duschen:

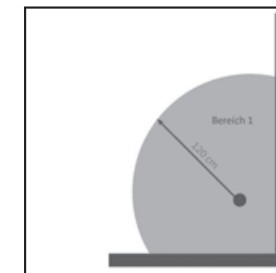

• Feste Wasseraustrittsstelle

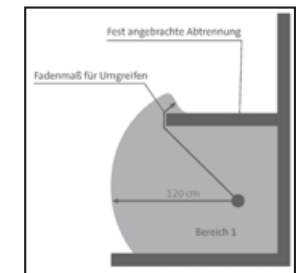







ALLGEMEINE INFORMATIONEN / GENERAL INFORMATION

ERSTE KENNZIFFER (BERÜHRUNGSSCHUTZ)

First digit	Höhe der Schutzarten Kurzbeschreibung	Schutz gegen das Eindringen von Fremdkörpern und Staub
IP 0X	ungeschützt	Kein besonderer Schutz
IP 1X	Schutz gegen Fremdkörper > 50 mm	Größere Körperteile wie z.B. eine Hand (jedoch keine Schutzmaßnahme gegen absichtliche Berührung) Fremdkörper > 50 mm Durchmesser
IP 2X	Schutz gegen Fremdkörper > 12 mm	Finger und dergleichen bis 80 mm Länge. Feste Fremdkörper > 12 mm Durchmesser
IP 3X	Schutz gegen Fremdkörper > 2,5 mm	Werkzeuge, Drähte usw. mit Durchmesser oder Dicke > 2,5 mm Fremdkörper > 2,5 mm Durchmesser
IP 4X	Schutz gegen Fremdkörper > 1 mm	Drähte oder Streifen dicker als 1 mm. Fremdkörper > 1 mm Durchmesser
IP 5X	Staubschutz 	Eindringen von Staub wird nicht völlig verhindert, aber Staub dringt nicht in solchen Mengen ein, dass ordnungsgemäßer Betrieb behindert wird.
IP 6X	Staubdicht 	Kein Eindringen von Staub

Die hier abgebildeten Tabellen spiegeln die Höhe der Kennziffer und den damit einhergehenden Schutz wieder. Vielfach ergibt sich auch ein Zusammenhang zwischen den beiden Kennziffern. Wenn also die Leuchte IP X5 entspricht, kann bei üblichen Aufbau IP 6X erreicht werden.

ZWEITE KENNZIFFER (WASSERSCHUTZ)

Zweite Kennziffer	Höhe der Schutzarten Kurzbeschreibung	Schutz gegen das Eindringen von Fremdkörpern und Staub
IP X0	ungeschützt	Kein besonderer Schutz
IP X1	Schutz gegen Tropfwasser 	Tropfwasser (senkrecht fallende Tropfen) verursacht keine Schädigung.
IP X2	Schutz gegen Tropfwasser unter 15°	Senkrecht fallende Tropfen dürfen keine Schädigung bewirken, wenn das Gehäuse bis zu 15° aus seiner bestimmungsgemäßen Gebrauchslage gekippt wird.
IP X3	Schutz gegen Sprühwasser 	Sprühwasser darf aus einer Neigung bis 60° gegen die Senkrechte keine Schädigung verursachen.
IP X4	Schutz gegen Spritzwasser 	Spritzwasser aus beliebiger Richtung darf keine Schädigung verursachen.
IP X5	Schutz gegen Strahlwasser 	Strahlwasser aus einer Düse aus einer beliebigen Richtung darf keine Schädigung verursachen.
IP X6	Schutz gegen schwere See	Schwere See oder Strahlwasser unter hohem Druck dürfen nicht in gefährbringender Menge in das Gehäuse eindringen.
IP X7	Schutz gegen Eintauchen 	Eindringen von Wasser in gefährbringender Menge darf beim Eintauchen in Wasser unter vorgegebenen Bedingungen hinsichtlich Druck und Zeit nicht stattfinden.
IP X8	Schutz gegen Untertauchen 	Das Gerät ist unter Bedingungen, die vom Hersteller genannt werden, für Dauerbetrieb unter Wasser geeignet. Anmerkung: Üblicherweise bedeutet dies, dass das Gerät vollständig abgedichtet ist. Jedoch kann dies bei bestimmten Geräten auch bedeuten, dass Wasser zwar eindringt, jedoch keine Schädigung verursacht.

Beispiel: IP 54 bedeutet, dass das Betriebsmittel gegen Staubablagerung im Innern und gegen Spritzwasser geschützt ist.

QUALITY UND SAFETY

WOFI LEUCHTEN are developed and manufactured according to the latest EN60598 standards. WOFI operates a (TQM) quality assurance system. The processes covered by the TQM system are set out in a flowchart and in other documentation.

All our lamps, components, machining and finishing processes and corresponding accreditation comply with the latest standards and regulations for the internal European market:

- Product Safety Act (ProdSG) dated 08.11.2011
 - the Low Voltage Directive 2006/95/EG
 - the Electromagnetic Compatibility Directive EMC 2004/108/EG
 - the Waste Electrical and Electronic Equipment Directive WEEE 2012/19/EU
 - Directive 2011/65/EU on the restriction of the use of certain hazardous substances in electrical equipment (RoHS 2)
 - Ecodesign Directive 2009/125/EG.
- Establishing a framework for the setting of eco-design requirements for energy-related products (ErP)
- Regulation (EC) 244/2009 on non directional household lamps as an implementing measure of the directive on eco-design requirements and directional lamps, LED lamps and related equipment (1194/2012/EU).

The lamps are packaged in environmentally friendly corrugated cardboard for safe transport. Our laboratory staff carry out regular operating and safety tests as well as checks on the lifetime of the lighting materials we use. Should you nevertheless encounter a fault, please contact your specialist dealer or the WOFI customer support desk as soon as possible.

TRANSFORMERS

1. Ring core transformers

The iron core is in the form of a ring around which copper coils are wound.

Important note: A slight humming noise is always possible when using undimmed and especially dimmed transformers.

2. Electronic transformers

These 'switch network' components offer load-independent secondary voltage and a soft start mechanism that prolongs the life of the lamp. Overload and short circuit protection are also included in a compact unit that is totally noise-free.

DIMMING LAMPS WITH BUILT-IN TRANSFORMERS

There is a corresponding dimmer for every transformer:

1. Block and ring core transformers

These types of transformers are dimmed according to the phase cut principle. In order to dim, they require a dimmer for iron core transformers. We recommend you use dimmer type 2247 from the firm Busch-Jäger.

2. Electronic transformers

Electronic transformers are dimmed according to the phase section principle. In order to dim, they require a dimmer for electronic transformers. We recommend you use dimmer type 6513 from the firm Busch-Jäger.

LIGHTING MATERIALS / LAMPS – LIGHTING AND LAMP TECHNOLOGY

Light can be produced in a number of ways involving different principles and media. We can use these variations along with developments in lighting technology to describe different forms of lamp or light source. The description includes the properties of the light itself such as colour, colour rendering and spectral composition as well as electrical output (W), average life (h), luminous flux (lumen) and illuminance (lux). We also use lighting properties that could be important for use under specific conditions (e.g. UV emission, heat radiation, ambient temperature) and other characteristics such as the lamp and base design and dimensions. Other important factors include the price and price-performance ratio and of course environmental impact.

We would like to give you an insight into the range of lamps produced by WOFI LEUCHTEN and their main characteristics.

1. Incandescent light bulbs

Light bulbs produce light by using electric current to heat a filament until it glows. The energy generated is radiated across a broad, homogeneous area of the spectrum similar to the distribution of daylight in the visible spectrum.

→ Classic light bulb

The classic light bulb converts most of the energy used into heat (96%) and only a small amount into light. It is a form of thermal radiator. The generated light is a very pleasant and warm light with very good colour rendering (1A). The light output and life of the bulb can be increased by adding noble gases (Argon and Krypton). The base models E14 and E27 make it possible to offer a wide range of different types. All purpose bulbs have an average life of approx. 1,000 h.

Voltage surges can lead to the early destruction of the bulb, while dimming can extend its life.

→ Halogen bulbs

The addition of halogens prevents the filament from evaporating and blackening the bulb wall. It produces a higher and more constant light output with a brilliant light and very good colour rendering (1A). Unwanted UV emissions, which speed up the colour fading process, for example, can be avoided using appropriate UV filters. The bulb wall is made of quartz which is resistant to the halogens. The lifespan of a halogen bulb varies considerably depending on the model but can be increased substantially through dimming. The base design also varies depending on the bulb type and needs to be considered when changing the bulb.

EXPLANATION OF TECHNICAL TERMS

Lumen

Luminous flux (lumen; lm) describes the useful power emitted by a light source in all directions adjusted for the international standard established for human eye sensitivity. The luminous flux values for light sources are given in the product lists of lamp manufacturers.

Lux

The value for illuminance (lux; lx) denotes how much light falls on a unit area of surface. The illuminance values required for artificial lighting are established by German Industrial Standards.

Luminous efficacy

Luminous efficacy is a measure of the efficiency of a light source. It tells us how many lumens per Watt are produced by a lamp: the higher the lumen/Watt ratio (lm/W), the more efficient the light source.

Light colour

The light colour of a lamp can be defined in terms of 'colour temperature' which is measured using the Kelvin (K) temperature scale. For example, an incandescent bulb with its warm white light may have a colour temperature of 2,700 K, a bright white fluorescent lamp 4,000 K and a fluorescent lamp producing near daylight conditions around 5,000 K.

GLASSES

Hand blown glasses

Hand blown glasses are individually made by skilled craftsmen and each glass is unique. Air bubbles within the glass are a sign of manual craftsmanship and are no reason for rejection.

Light output (lm / W)

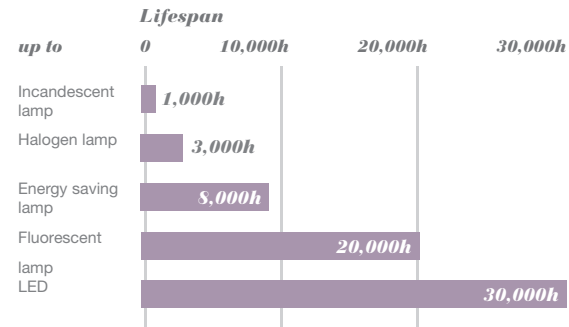
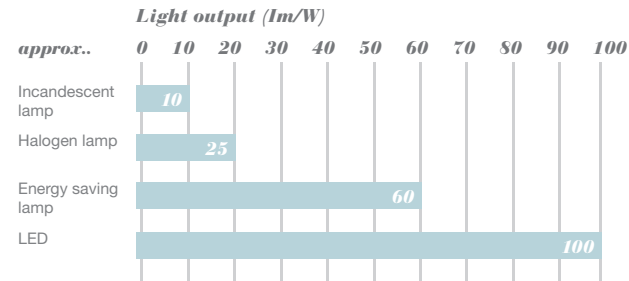

Lichtfarbe in Kelvin

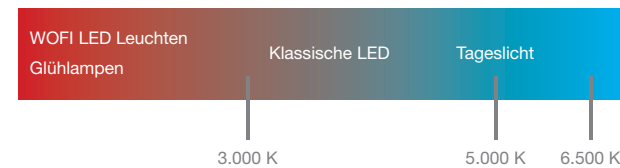

The following dimmers are suitable for use with our pendants

Manufacturer	Dimmer Number	Description
Berker	286710	Tronic Drehdimmer 20-360W
GIRA	0307 00	Tronic Dimmer-Einsatz 20-525W
Jung	225TDE	Tronic Drehdimmer 20-525W
Peha	433HAB-60	Tronic Drehdimmer; Phasenabschnitt 20-250W
Siemens	5 TC8 284	NV-Dimmer-Einsatz für elektr. Trafos 20-525VA

To differ:

(A) High voltage halogen bulbs

High voltage halogen bulbs work directly with mains voltage. They are costly to produce but can reach an output of 500 W depending on the type and a lifespan of up to 2,000 h.

(B) Low voltage halogen bulbs

Low voltage halogen bulbs need a transformer to convert mains voltage into a low safety voltage – generally 12 V. They are very small, and the tiny coils and corresponding reflectors allow for efficient directional light projection. The maximum output is 100W, and the average lifespan is between 2,000 h and 4,000 h depending on the type.

→ IRC technology (Infra Red Coating)

A special coating on the bulb wall reflects the heat generated back onto the glowing coil in order to maintain it at the correct operating temperature. As a result, it is possible to boost light output by around 30% with a corresponding saving in energy. IRC technology is used in both high voltage and low voltage lamps.

2. Fluorescent lamps

Fluorescent lamps are based on low pressure gas discharge technology. They require a ballast. The cylindrical glass tube is filled with a gas mixture. They are electrodes at each end of the tube. When connected to the power source, the gas mixture emits ultra-violet light which is converted into visible light by the coating material on the inside of the tube. The composition and quality of this coating determines the light colour and colour rendering (1A, 1B) of fluorescent lamps.

Fluorescent lamps are characterised by minimal power consumption alongside a high light output and long lifespan. They produce very little heat. The humming and flickering, unnatural colours and uncomfortable sensation associated with earlier fluorescent lamps have now been eliminated thanks to modern technology and the right choice of fluorescent material.

Important note: Fluorescent lamps should not be disposed of in the ordinary household waste. They should be taken for recycling to the municipal disposal point for hazardous waste.

→ Tubular fluorescent lamps

There are a range of models that differ according to design and size. These lamps are principally distinguished by the diameter of the glass tube in millimetres or inches, e.g. T26 or T8, T16 or T5.

Fluorescent lamps employ ballast devices with T8 lamps using electronic or low-loss magnetic systems. T5 lamps can only be operated using an electronic ballast device. This has a number of advantages. Both lifespan and light output are increased by around 25%; there is an immediate no-flicker start, flicker-free operation and an automatic cut-out in case of fault, as repeated switching on and off can damage the lamp. The average lifespan is around 12,000 h, up to 20,000 h for T5 lamps. A special

electronic control system is needed for dimmer operation. This makes it possible to dim the light without affecting the colour quality through changes in the spectral radiation curve.

Fluorescent lamps can also be found in circular form allowing for flat designs that produce a rotationally symmetric distribution of light.

→ Compact fluorescent lamp (Energy saving lamp ESL)

As the name suggests, this type of fluorescent lamp has a compact design. A wide range of sizes, output classes and tube and base designs is available. Colour rendering is in the 1B category (good), while the lifespan lies between 6,000 h and 15,000 h depending on the type. The energy saving lamp (ESL) with its integrated ballast and conventional screw-in base (E14, E27) is increasingly replacing the incandescent bulb in energy conscious households.

3. LED (Light Emitting Diodes)

LEDs (Light diodes) are semi-conductor diodes that work on the principle of electroluminescence. Research aimed at promoting efficiency and the development of white LEDs has made it possible to use light diodes for illumination.

LEDs are based on semi-conductor connections that convert electricity directly into light. In terms of their size, efficiency, durability and lifespan, light diodes represent an improvement over conventional incandescent lamps in the same way that semi-conductor diodes are superior to the diode vacuum tube. They are set to change lighting technology in the same way that semi-conductor technology has changed electronics.

In the future, WOFI LEUCHTEN will use LEDs to produce lamps that are completely new in terms of design, lighting effect, control and other properties. It is possible to make two or three dimensional flat or linear lamps in every conceivable shape that give off directional light. Every LED emits directional light and the light colour can be adjusted by means of colour LEDs. The colour rendering of LED light can be combined through several areas of the spectrum to meet class 1A values.

GENERAL INFORMATION

SAFETY ZONES FOR THE USE OF LIGHTS IN THE BATHROOM

Bathrooms are damp rooms, and special care must be taken wherever electricity and damp come together. The following regulations have been drawn up in the interests of safety. They are aimed at avoiding hazards and accidents. Three so-called safety areas for bathrooms are set out in the standard DIN VDE (Germany Industrial Standard, Association of German Electrotechnicians) 0100 Section 701.

Safety area 0

The area inside the bath tub or shower tray, for example when using underwater lights. Only appliances with a protection low voltage of a maximum of 12 Volts may be used; these must be specifically authorised for installation inside baths/shower trays. They must have a protection rating of at least IP X7. Protection low voltage means that higher voltage circuits supply a low voltage circuit; the two must be securely separated.

Safety area 1

This defines the area within the vertical limits of the bath or shower. If there is no shower tray, the upper limit is defined as a radius of 120 centimetres around the shower head when hung up. The lower limit is the floor; the area stretches 2.25 metres above the floor. Safety area 1 also requires the use of protection low voltage lights with a maximum voltage of 12 Volts. There may be no transformers in safety areas 1 or 0.

Safety area 2

This adjoins area 1 and is 60 centimetres deep. Any lights

used in areas 1 and 2 must have a protection rating of at least IP X4; for devices which spray jets of water, for example massage jets, lights must have a protection rating of at least IP X5. Showers without shower trays generally only cover area 1.

There are no specific safety requirements for the rest of the room. Plugs and switches may not be installed in areas 0, 1 or 2. However, switches built in to lights are allowed provided they do not reduce the protection rating. Plastic sheathed lighting wiring may be laid underneath or over the plaster; flat webbed house wires may only be laid at least six centimetres below the plasterwork.

The protection rating is lights' operational safety classification. It is expressed in a two-digit IP code (Ingress Protection). If one of the two digits is not given, this is represented by an X. The first digit concerns resistance to solid objects and dust; more important for bathroom lights is the second digit, which relates to resistance/permeability to water and damp.

Three classes of protection are also defined for lights; these set out the scope of protective provisions against electric shocks:

Protection class I

Lights to be connected to the mains earth.

Protection class II

Lights with additional or reinforced insulation with no earth terminal.

Protection class III

Lights for use with protection low voltage.

SCHEMATIC DIAGRAM OF THE SAFETY AREAS FOR BATHTUBS AND SHOWERS, WITH AND WITHOUT A BUILT-IN PARTITION

Bathtubs:

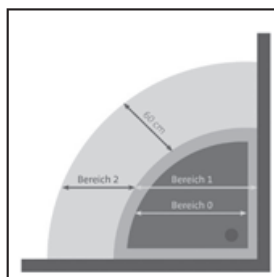

- Fixed plughole

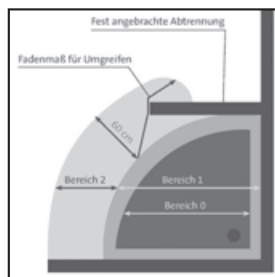

Showers:

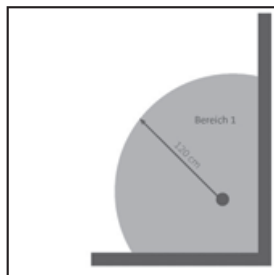

- Fixed plughole

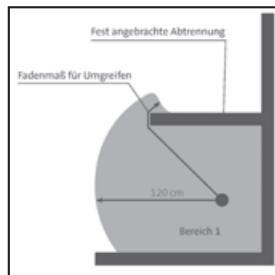

FIRST DIGIT (PROTECTION AGAINST CONTACT)

Erste Kennziffer	Level of protection Brief description	Protection against the ingress of foreign bodies and dust
IP 0X	No protection	No special protection
IP 1X	Protected against foreign bodies > 50 mm	Larger body parts e.g. hands (accidental contact only) Foreign bodies > 50 mm diameter
IP 2X	Protected against foreign bodies > 12 mm	Fingers and similar objects up to 80 mm long solid foreign bodies > 12 mm diameter
IP 3X	Protected against foreign bodies > 2.5 mm	Tools, wires etc. with a diameter or thickness > 2.5 mm. Foreign bodies > 2.5 mm diameter
IP 4X	Protected against foreign bodies > 1 mm	Wires or strips thicker than 1 mm. Foreign bodies > 1 mm diameter
IP 5X	Protected against dust	Ingress of dust not completely prevented, but dust does not enter in quantities which inhibit proper operation.
IP 6X	Totally protected against dust	No ingress of dust

The tables below reflect the digit rating and the associated level of protection. In many cases, the two digits are also connected: if a lights meets the **IP X5** standard, **IP 6X** can also be met under usual installation conditions.

SECOND DIGIT (PROTECTION AGAINST WATER)

Second digit	Level of protection Brief description	Protection against the ingress of foreign bodies and dust
IP X0	Not protected	No special protection.
IP X1	Protected against dripping water	Dripping water (vertically falling drops) causes no damage.
IP X2	Protected against dripping water when enclosure is tilted up to 15°	Vertically falling drops should cause no damage if the enclosure is tilted by up to 15° from its proper position.
IP X3	Protected against sprayed water	Water sprayed from an angle of 60° shall not cause any damage.
IP X4	Protected against splashed water	Water splashed from a nozzle from any direction shall cause no damage.
IP X5	Protected against water projected in jets	Jets of water projected by a nozzle from any direction shall cause no damage.
IP X6	Protected against heavy seas	Heavy seas and water projected in powerful jets shall not enter the enclosure in harmful quantities.
IP X7	Protected against temporary immersion	Water should not penetrate in harmful quantities when the device is briefly immersed under specified pressure and for a specified time.
IP X8	Protected against continuous immersion	In conditions by the manufacturer, the device is suitable for continuous use underwater. Please note: This usually means that the device is completely sealed and watertight. However, with certain devices it can mean that water does ingress, but does not cause any damage.

Example: **IP 54** means that the device is protected against dust collecting inside and against splashed water.

ALLGEMEINE VERKAUFSBEDINGUNGEN

1. Allen unseren Lieferverträgen – auch zukünftigen – liegen unsere allgemeinen Verkaufsbedingungen zugrunde. Spätestens mit der Entgegennahme der Lieferung gelten unsere Bedingungen als angenommen. Einkaufs-, Lieferungs- und Zahlungsbedingungen des Bestellers haben keine Gültigkeit, soweit sie unseren Allgemeinen Verkaufsbedingungen entgegenstehen. Alle bisherigen Bedingungen und Vereinbarungen verlieren mit Erscheinen des Kataloges WOFI LEUCHTEN 2016 ihre Gültigkeit.
2. Auf das Vertragsverhältnis findet ausschließlich deutsches Recht Anwendung.
3. Angebote sind freibleibend und verpflichten uns nicht zur Auftragsannahme.
4. Die durch unsere Vertreter getroffenen Vereinbarungen und mündlichen Absprachen erhalten erst durch unsere schriftliche Bestätigung Rechtsverbindlichkeit.
5. Liefertermine werden nach Möglichkeit eingehalten. Verzögerungen in der Lieferung berechtigen nicht zu Schadenersatzansprüchen. Teillieferungen können durchgeführt werden. Ereignisse höherer Gewalt oder Betriebsstörungen entbinden uns von unserer Lieferungsverpflichtung. Schadenersatzansprüche des Käufers wegen Lieferverzug sind ausgeschlossen. Der Käufer ist nicht berechtigt, vom Vertrag zurückzutreten, ohne eine angemessene Lieferfrist zu setzen.
6. Die Lieferung erfolgt ab Werk auf Rechnung und Gefahr des Empfängers. Bei Anlieferung mit unseren LKWs innerhalb Deutschlands berechnen wir einen Frachttanteil in Höhe von 6% des Warenwertes.
7. Technische Änderungen behalten wir uns vor.
8. Beanstandungen können nur berücksichtigt werden, wenn sie uns innerhalb 8 Tagen nach Lieferung schriftlich mitgeteilt worden sind. Für Beschädigungen auf dem Transport wird grundsätzlich kein Ersatz geleistet. Rücksendungen werden nur nach vorheriger Vereinbarung anerkannt. Für nachweislich mangelhafte Lieferung wird kostenloser Ersatz gewährt. Weitergehende Ansprüche jeder Art sind ausgeschlossen.
9. Unsere Rechnungen sind zahlbar in Euro innerhalb 8 Tagen nach Rechnungsdatum in bar abzüglich 2% Skonto, oder innerhalb 30 Tagen in bar ohne Abzug. Schecks und Wechsel gelten erst mit der Einlösung als Barzahlung. Bei Überschreiten der Zahlungsfrist berechnen wir 4% über dem jeweiligen Diskontsatz als Verzugszinsen oder Diskontspesen. Kommt der Besteller mit einer Zahlung in Verzug, so werden alle anderen Forderungen sofort zur Zahlung fällig, ohne dass es einer gesonderten Inverzugsetzung bedarf. Die Aufrechnung mit Gegenforderungen des Bestellers ist für alle denkbaren Fälle ausgeschlossen, es sei denn, die Gegenansprüche sind unbestritten oder rechtskräftig festgestellt.
10. Für Lieferungen und Leistungen an Besteller im Ausland gilt als ausdrücklich vereinbart, dass alle Kosten der Rechtsverfolgung durch den Lieferanten im Falle des Zahlungsverzuges des Bestellers, sowohl gerichtliche als auch außergerichtliche, zu Lasten des Bestellers gehen.

11. Wir behalten uns für den jeweiligen Kaufvertrag das Eigentum an der gelieferten Ware bis zur völligen Bezahlung des Kaufpreises einschließlich Zinsen und Kosten und bis zur völligen Einlösung der hierfür gegebenen Wechsel und Schecks vor.
12. Die Fa. WOFI LEUCHTEN ist berechtigt, ihre Forderungen aus Lieferungen und Leistungen zu Finanzierungszwecken abzutreten.
13. Erweiterter und verlängerter Eigentumsvorbehalt: Bis zur Bezahlung aller Ansprüche aus der Geschäftsverbindung, einschließlich etwaiger Refinanzierungs- oder Umkehrwechsel, behalten wir uns das Eigentum an unseren Warenlieferungen, die nur im ordnungsgemäßen Geschäftsverkehr veräußert werden dürfen, vor. Das gilt auch dann, wenn einzelne oder unsere sämtlichen Forderungen in eine laufende Rechnung aufgenommen wurden und der Saldo gezogen und anerkannt ist. Durch eine evtl. Verarbeitung dieser Waren erwirbt der Käufer kein Eigentum an den ganz oder teilweise hergestellten Sachen; die Verarbeitung erfolgt unentgeltlich ausschließlich für den Verkäufer, der Eigentümer der neu hergestellten Sache wird. Der Käufer tritt hiermit die Forderung aus einem Weiterverkauf der Vorbehaltsware ab, und zwar insoweit, als die Ware verarbeitet ist. Er ist ermächtigt, die abgetretenen Forderungen so lange einzuziehen, wie er sein Zahlungspflicht gegenüber uns vertragsmäßig nachkommt. Der Käufer hat uns Zugriffe Dritter auf die unter Eigentumsvorbehalt gelieferten Waren oder die abgetretenen Forderungen sofort mitzuteilen.

14. Jede Teillieferung gilt in Bezug auf Berechnung und Bezahlung, nicht aber hinsichtlich des Eigentumsvorbehaltes, als besonderes Geschäft.
15. Nichteinhaltung der vereinbarten Zahlungsbedingungen oder sonst. Vertragsverletzungen geben uns das Recht unter vorheriger Ankündigung das Zurückbehaltungsrecht für sämtliche noch ausstehenden Lieferungen auszuüben oder Vorauszahlung zu verlangen oder von der Lieferungsverpflichtung ganz zurückzutreten.

16. Erfüllungsort für Lieferung und Zahlung für beide Teile ist Meschede-Freienohl, Gerichtsstand für beide Teile ist Meschede.

17. Die vorstehenden Bedingungen gelten als verbindlich, soweit nicht ausdrücklich schriftlich andere Vereinbarungen getroffen werden.

WOFI LEUCHTEN
Wortmann & Filz GmbH

GENERAL TERMS AND CONDITIONS OF SALE

1. These General Terms and Conditions of Sale apply to all our current and future supply agreements. The customer shall be deemed to have accepted our terms no later than the point at which the goods are received and accepted. Any purchase, supply and payment terms of the ordering party that do not match our own sales terms shall be regarded as invalid. All previous terms and conditions and agreements shall expire on issue of the 2016 WOFI LEUCHTEN catalogue.
2. The contractual relationship shall be subject exclusively to German law.
3. All offers made by WOFI are subject to change without notice and do not constitute an obligation to accept specific orders.
4. Agreements and oral understandings entered into by our representatives only acquire legally binding force when confirmed by us in writing.

5. We make every effort to comply with supply deadlines. Supply delays do not confer an entitlement to compensation. An order may be supplied by means of partial deliveries. Our obligation to deliver may be suspended by incidents of force majeure or operational disruption. The purchaser may not claim compensation for delays in delivery. The purchaser may not cancel the agreement without granting us a suitable extension period in which to supply the goods.

6. Deliveries are made ex factory for the account and at the risk of the recipient. Where the goods are delivered using our own HGV transport within Germany, we shall add a further 6% of the value of the goods to cover shipping.

7. We reserve the right to make technical changes.

8. Complaints can only be considered if they are submitted to us in writing within eight days of delivery. Under no circumstances will we provide replacements for any goods damaged in transit. Goods returned will only be accepted by prior agreement. Replacement goods will be provided free of charge where there is adequate evidence of a faulty delivery. No other claims of any kind will be considered.

9. Our invoices are payable either within 8 days of the invoice date in cash less a discount of 2% or within 30 days in cash without a discount. Cheques and bills of exchange will only be regarded as cash payment once they have been paid out. We will charge 4% above the current discount rate by way of default interest or discount charges on all delayed payments. Once a single invoice falls overdue for payment, all other amounts owed by that customer shall automatically fall due for immediate payment without a requirement for us to issue a specific default notice. The Customer may not under any foreseeable circumstances offset any of its own claims against the amounts it owes unless those claims are either uncontested or legally established.

10. In the case of deliveries made to foreign customers it is expressly agreed that all legal and other costs incurred by the supplier in seeking legal recourse following non-payment of invoices by the customer shall be paid by the ordering party.

11. For each supply agreement, we reserve title to the goods delivered until they have been paid for in full including any interest and costs and up to the complete discharge of any bills or cheques used as payment.

12. Where required for financing purposes, WOFI LEUCHTEN is entitled to assign to a third party its own claims to payment for the goods and services it has supplied.

13. Extended reservation of title. We reserve title to all the goods we supply until we have received full payment for all amounts owed to us from the business transaction including any refinancing or acceptor's bills used. The goods may only be sold in the ordinary course of business. This reservation shall also apply where individual amounts owed to us or our entire claims have been included in a running account and a statement has been produced and the balance accepted. Any further processing of the goods shall not confer a right of title to the partially or fully produced new items; the processing shall be undertaken free of charge exclusively on behalf of the seller who shall acquire title to the newly produced item. The purchaser hereby assigns to us, to the extent that the goods have been reworked, its own claims for payment following any resale of the reserved title goods. The purchaser is entitled to collect the amounts corresponding to these reassigned claims for as long as it meets its own contractual obligation to pay us. The purchaser must inform us immediately of any attempts by third parties to obtain the reserved title goods or the reassigned claims.

14. Each partial delivery shall be considered as a separate transaction with regard to invoicing and payment but not with regard to reservation of title.

15. Where the customer fails to comply with agreed payment terms or with other provisions of the agreement, we shall be entitled, subject to our giving prior notice, to withhold all outstanding deliveries or demand advance payment or withdraw entirely from our obligation to supply the goods in question.

16. For both parties, the place of fulfilment for supply and payment shall be Meschede-Freienohl. The place of jurisdiction for both parties shall be Meschede.

17. The above terms and conditions are binding in the absence of any other expressly written terms agreed between the parties.

WOFI LEUCHTEN
Wortmann & Filz GmbH

INDEX / INDEX

Der vorliegende Index ist nach WOFI-Serien-Nummern sortiert. Die drei Ziffern vor dem 1. Punkt geben die genaue Serie an.

The present index participates sorted after WOFI-series-numbers. The three digits before the point declare the exactly series-numbers.

Im Nachfolgenden handelt es sich um die Serie 006.
It is in the following about the series 006.

Serien-Nummer
Series-Number

3006.01.32.9000 WOFI Artikel-Nummer
WOFI Item-Number

Serie Series	Art-Nr. Item-No.	EAN-Nummer EAN-Number	Seite Page	Serie Series	Art-Nr. Item-No.	EAN-Nummer EAN-Number	Seite Page	Serie Series	Art-Nr. Item-No.	EAN-Nummer EAN-Number	Seite Page	Serie Series	Art-Nr. Item-No.	EAN-Nummer EAN-Number	Seite Page
006	3006.01.32.9000	4003474261898	085	090	7090.05.01.0000	4003474302492	065	120	6120.01.54.0000	4003474291048	066	175	9175.04.01.0000	4003474286396	026
	3006.01.64.9000	4003474264738	085	093	4093.01.01.0000	4003474301341	095	128	3128.02.09.0000	4003474169484	051		9175.09.01.0000	4003474286402	026
017	3017.02.54.0000	4003474299495	016		7093.02.01.0000	4003474301358	095		4128.01.09.0000	4003474168647	051	192	6192.01.01.0000	4003474269436	073
	4017.02.54.0000	4003474299501	016		9093.06.01.0000	4003474301600	095		5128.03.09.0000	4003474168654	051	193	3193.05.01.0000	4003474284231	042
	8017.02.54.0000	4003474299518	016	099	6099.24.01.0000	4003474302461	043		6128.01.09.0000	4003474168661	051		4193.01.01.0000	4003474280714	042
	9017.06.54.0000	4003474299525	016	102	9102.05.01.0000	4003474280691	105		7128.02.09.0000	4003474168432	051		4193.01.01.0000	4003474280714	100
024	6024.01.01.0000	4003474286112	039		9102.09.01.0000	4003474283876	105	141	6141.01.64.0000	4003474169200	073		4193.01.01.0044	4003474296234	136
	8024.01.01.0000	4003474286129	039	104	6104.01.64.0506	4003474235585	071	145	7145.01.01.0000	4003474305264	063		8193.01.01.0000	4003474284248	042
	8024.01.01.0000	4003474286129	078	111	8111.02.32.0510	4003474236285	080	146	4146.01.01.0000	4003474304717	095		9193.03.01.0000	4003474280738	042
	9024.01.01.0000	4003474286136	039		8111.02.64.0510	4003474235554	080		9146.03.01.0000	4003474304823	095		9193.03.01.0000	4003474280738	100
025	8025.01.06.0000	4003474287652	082	112	8112.02.32.0010	4003474235561	080	161	8161.01.76.0000	4003474301549	029		9193.03.01.0044	4003474296241	136
	8025.01.10.0000	4003474287669	082		8112.02.64.0010	4003474236308	080		9161.01.76.0000	4003474301075	029		9193.06.01.0000	4003474281124	042
	8025.01.70.0000	4003474287676	082	116	4116.01.01.0000	4003474250991	124		9161.03.76.0000	4003474301563	029		9193.06.01.0000	4003474281124	100
037	9037.06.01.0000	4003474286914	038		4116.01.06.0000	4003474251004	124	162	3162.02.76.0000	4003474301570	029		9193.06.01.0044	4003474296326	136
060	9060.06.01.0000	4003474283272	043		7116.02.01.0000	4003474251042	124		7162.03.76.0000	4003474303147	029	195	4195.01.01.0000	4003474289205	115
	9060.06.01.0000	4003474283272	100		7116.02.06.0000	4003474251059	124		8162.02.76.0000	4003474301525	029		7195.02.01.0000	4003474289212	115
	9060.06.01.0044	4003474296074	136		7116.03.01.0000	4003474251073	124	163	9163.01.01.1000	4003474306285	093		9195.04.01.0000	4003474283746	099
067	9067.06.64.0000	4003474291000	102		7116.03.06.0000	4003474251080	124		9163.02.01.0000	4003474301402	093		9195.04.01.0000	4003474283746	115
	9067.08.64.0000	4003474291024	102		9116.06.01.0000	4003474251134	124		9163.03.01.0000	4003474299938	093		9195.04.01.0500	4003474289229	115
076	4076.01.01.0000	4003474248523	125		9116.06.06.0000	4003474251141	124		9163.05.01.0000	4003474305462	093		9195.05.01.0000	4003474303963	099
	7076.02.01.0000	4003474248530	125	117	9117.01.54.0000	4003474291031	094	172	4172.01.06.0000	4003474206424	108		9195.06.01.0000	4003474281599	099
	9076.03.01.0000	4003474248547	125		9117.01.54.0000	4003474291031	026		4172.02.06.0000	4003474206417	108		9195.06.01.0000	4003474281599	115
	9076.04.01.0000	4003474248554	125		9117.01.54.0CLC	4003474305882	094	175	7175.05.01.0000	4003474282879	026		9195.06.01.0500	4003474289236	115

Serie Series	Art-Nr. Item-No.	EAN-Nummer EAN-Number	Seite Page	Serie Series	Art-Nr. Item-No.	EAN-Nummer EAN-Number	Seite Page	Serie Series	Art-Nr. Item-No.	EAN-Nummer EAN-Number	Seite Page	Serie Series	Art-Nr. Item-No.	EAN-Nummer EAN-Number	Seite Page
195	9195.08.01.0000	4003474304786	099	240	8240.01.01.0010	4003474272948	052	276	9276.01.01.1200	4003474280929	097	354	9354.03.64.0000	4003474183404	126
197	9197.05.64.0000	4003474281148	098		9240.04.01.0000	4003474271132	052		9276.01.01.1300	4003474280943	097		9354.04.32.1000	4003474206998	127
	9197.09.64.0000	4003474281155	098		9240.06.01.0000	4003474271118	052	277	6277.05.22.0000	4003474291055	066		9354.04.64.0000	4003474182810	126
204	7204.03.64.0000	4003474140155	074		9240.07.01.0000	4003474271101	052		6277.05.64.0000	4003474290034	066	360	4360.06.01.0000	4003474231969	054
	7204.04.64.0000	4003474140162	074		9240.08.01.0000	4003474271125	052	278	9278.04.01.0000	4003474305325	104		7360.04.01.0000	4003474240558	054
	7204.05.64.0000	4003474140179	074	244	9244.08.54.0000	4003474304830	098	306	3306.05.01.0000	4003474243054	053		7360.07.01.0000	4003474240510	055
216	4216.01.01.0000	4003474110004	096	245	9245.01.06.2644	4003474296098	132		4306.02.01.0000	4003474242507	055		9360.04.01.0000	4003474231884	054
	7216.02.01.0000	4003474289762	096		9245.02.06.4044	4003474299570	132		8306.01.01.0000	4003474243108	053		9360.06.01.0000	4003474231433	055
	7216.04.01.0000	4003474289786	096	248	6248.01.64.0200	4003474128733	072		8306.03.01.0000	4003474243290	053		9360.09.01.0000	4003474231419	055
	9216.04.01.0000	4003474289793	096		6248.01.64.0250	4003474128740	072		9306.03.01.0000	4003474243061	053		9360.16.01.0000	4003474231440	054
224	4224.01.01.0000	4003474301464	113		6248.01.64.0300	4003474128757	072		9306.12.01.0000	4003474191560	053	361	3361.01.09.0000	4003474281315	085
	7224.02.01.0000	4003474301440	113		6248.01.64.0350	4003474131450	072	308	8308.01.06.0300	4003474179186	146		3361.01.64.0000	4003474281308	085
	7224.04.01.0000	4003474301457	113		8248.01.06.0200	4003474128474	078		8308.01.06.0400	4003474179193	146		4361.01.09.0000	4003474281346	123
	9224.06.01.0000	4003474299976	113		8248.01.06.0250	4003474128481	078		8308.01.06.0500	4003474179209	146		4361.01.64.0000	4003474281353	123
	9224.06.01.3000	4003474300801	113		8248.01.06.0300	4003474128498	078	313	4313.01.01.0000	4003474268552	031		7361.02.09.0000	4003474281360	123
225	4225.02.01.0000	4003474219493	058	254	4254.01.64.0000	4003474132662	116		7313.01.01.0000	4003474268569	031		7361.02.64.0000	4003474281377	123
	5225.05.01.0000	4003474209609	058		4254.01.64.0500	4003474281933	116		8313.01.01.0000	4003474268576	031		9361.04.09.0000	4003474281391	123
	5225.08.01.0000	4003474207117	058		7254.02.64.0000	4003474128566	116	317	3317.02.64.0000	4003474281100	086		9361.04.64.0000	4003474281407	123
234	3234.01.01.0000	4003474255002	014		7254.03.64.1000	4003474281940	065	343	8343.01.64.0000	4003474207490	085		9361.06.09.0000	4003474281414	123
	3234.01.01.0CLC	4003474305837	014		7254.05.64.0000	4003474281957	065	346	4346.01.01.0000	4003474301433	121		9361.06.64.0000	4003474281421	123
	4234.01.01.0000	4003474280790	015		9254.04.64.0000	4003474281926	116		7346.02.01.0000	4003474301655	121	369	9369.01.01.0000	4003474286839	040
	4234.01.01.0CLC	4003474305844	015		9254.06.64.0000	4003474283753	116		9346.04.01.0000	4003474301662	121		9369.01.64.1000	4003474304557	040
	7234.01.01.0000	4003474280783	015	270	7270.04.64.0000	4003474268804	068		9346.06.01.0000	4003474306216	121	376	9376.01.64.3044	4003474296708	139
	7234.01.01.0CLC	4003474305851	015	272	4272.01.01.0000	4003474303741	103	350	9350.01.64.0000	4003474263533	091	377	4377.01.64.0000	4003474273327	120
	8234.01.01.0000	4003474280806	015		4272.02.01.0000	4003474303758	103		9350.01.64.0400	4003474263854	091		7377.02.64.0000	4003474273334	120
	8234.01.01.0CLC	4003474305868	015		9272.04.01.0000	4003474281964	103	354	4354.01.32.1000	4003474206943	127		9377.03.64.0000	4003474273358	120
	9234.01.01.0000	4003474127187	014		9272.09.01.0000	4003474281971	103		4354.01.32.1500	4003474206950	127		9377.04.64.0000	4003474273341	120
	9234.01.01.0CLC	4003474305875	014	275	4275.01.64.0000	4003474281513	019		4354.01.64.0000	4003474182780	126		9377.06.64.0000	4003474273365	120
	9234.03.01.0000	4003474303833	014		7275.01.64.0000	4003474281520	019		4354.01.64.0500	4003474183381	126	389	3389.02.02.3000	4003474169569	087
	9234.03.01.0500	4003474306100	014		8275.01.64.0000	4003474281544	019		7354.02.32.1000	4003474206967	127		3389.02.09.3000	4003474169729	087
240	3240.05.01.0000	4003474272931	052	276	9276.01.01.0200	4003474280820	097		7354.02.64.0000	4003474182797	126		3389.02.64.0000	4003474168265	087
	6240.01.01.0000	4003474271040	052		9276.01.01.0300	4003474280844	097		7354.03.64.0000	4003474182803	126	394	9394.04.54.0000	4003474300221	033

INDEX / INDEX

Serie Series	Art-Nr. Item-No.	EAN-Nummer EAN-Number	Seite Page	Serie Series	Art-Nr. Item-No.	EAN-Nummer EAN-Number	Seite Page	Serie Series	Art-Nr. Item-No.	EAN-Nummer EAN-Number	Seite Page	Serie Series	Art-Nr. Item-No.	EAN-Nummer EAN-Number	Seite Page
394	9394.08.54.0000	4003474302355	033	475	4475.01.01.0000	4003474277714	104	545	9545.01.06.0000	4003474297866	090	622	4622.01.01.0044	4003474296388	133
399	7399.04.64.0000	4003474180830	071	475	7475.02.01.0000	4003474277721	104	545	9545.01.06.0044	4003474298900	132	623	4623.01.01.0044	4003474296364	135
404	3404.01.76.0000	4003474305806	032		9475.04.01.0000	4003474277738	104	547	9547.01.64.0300	4003474284408	097		4623.02.01.0044	4003474296371	135
	7404.02.76.0000	4003474305813	032	494	6494.01.01.0000	4003474259550	073		9547.01.64.0400	4003474284415	097	624	9624.05.01.0320	4003474290379	103
	8404.01.76.0000	4003474305820	032	500	4500.01.01.0044	4003474296258	136	557	3557.01.01.0450	4003474281889	036	625	3625.01.01.0000	4003474280615	013
416	9416.08.01.0000	4003474286099	038		4500.02.01.0044	4003474296265	136		3557.01.01.0850	4003474281896	036		3625.01.01.0CLC	4003474305752	013
419	9419.02.64.0280	4003474182452	107	501	4501.01.01.0044	4003474296289	134		3557.01.01.1100	4003474281902	036		4625.01.01.0000	4003474004211	013
420	7420.04.64.0000	4003474281865	062		7501.02.01.0044	4003474296296	134		3557.05.01.0000	4003474279480	036		4625.01.01.0CLC	4003474305769	013
423	8423.01.06.0000	4003474270418	082		7501.03.01.0044	4003474296302	134		9557.08.01.0000	4003474291192	037		7625.01.01.0000	4003474280608	012
	8423.01.10.0000	4003474289564	082		7501.04.01.0044	4003474296319	134		9557.10.01.0000	4003474283197	036		7625.01.01.0900	4003474302850	011
445	9445.04.01.0000	4003474293103	101	502	4502.01.01.0044	4003474296340	133		9557.16.01.0000	4003474283203	037		7625.01.01.0CLC	4003474305776	012
	9445.05.01.0000	4003474293165	101		4502.03.01.0044	4003474296357	133	568	4568.01.01.0220	4003474246260	059		7625.01.01.1000	4003474301723	011
446	9446.05.01.0000	4003474257068	059		9502.04.01.0044	4003474296333	133		6568.01.01.0350	4003474242712	059		8625.01.01.0000	4003474280622	012
448	3448.03.01.0000	4003474304564	033	507	3507.04.54.0000	4003474303055	028		8568.01.01.0130	4003474245782	059		8625.01.01.0CLC	4003474305783	012
	8448.03.01.0000	4003474301877	033		4507.01.54.0000	4003474302997	028		9568.01.01.0350	4003474242743	059		8625.01.01.1000	4003474301747	011
449	3449.01.01.0000	4003474259703	050		7507.04.54.1000	4003474303079	028	581	4581.02.06.0000	4003474259376	106		9625.01.01.0000	4003474285856	013
	6449.01.01.0250	4003474261935	050		8507.01.54.0000	4003474303086	028		4581.02.64.0000	4003474259352	106		9625.01.01.0CLC	4003474305790	013
	6449.01.01.0350	4003474261928	050		9507.04.54.0000	4003474303062	028	587	3587.01.01.0000	4003474301914	021	628	3628.01.50.0300	4003474297743	145
	8449.01.01.0000	4003474259277	050	509	7509.02.54.0000	4003474303109	062		4587.01.01.0000	4003474246857	021		3628.01.50.0600	4003474297750	145
450	3450.01.64.0000	4003474271606	048	510	8510.01.01.0000	4003474301891	040		7587.01.01.0000	4003474301921	020		3628.01.50.0900	4003474297767	145
	6450.01.64.0250	4003474273686	048		8510.01.01.0000	4003474301891	078		8587.01.01.0000	4003474301907	021		4628.01.50.0000	4003474297774	145
	7450.02.64.0000	4003474270593	048	513	4513.01.01.0344	4003474297811	135		9587.01.01.0000	4003474305929	021	637	9637.01.64.0210	4003474168821	107
	7450.03.64.0000	4003474270586	048		4513.01.01.0644	4003474296401	135	592	8592.01.54.0120	4003474301952	079	641	4641.01.01.0000	4003474269290	107
	8450.01.64.0000	4003474271613	048		4513.01.01.0944	4003474297828	135		8592.01.54.0200	4003474301969	079		7641.02.01.0000	4003474269306	107
	8450.01.64.0250	4003474272658	048	514	4514.01.01.0044	4003474296418	135	593	8593.01.54.0000	4003474302102	079	658	3658.02.64.0000	4003474295237	086
451	4451.01.64.0000	4003474207155	108	524	3524.01.01.0000	4003474295688	023	596	7596.04.64.0000	4003474235639	067	662	9662.01.06.0510	4003474287829	091
	4451.01.64.0500	4003474218724	108		4524.01.01.0000	4003474296432	023		7596.06.64.0000	4003474235509	067	664	7664.02.64.0000	4003474201405	069
468	3468.01.32.0000	4003474285924	084		6524.01.01.0000	4003474295695	023	611	8611.01.06.0300	4003474297132	144		7664.03.64.0000	4003474201429	069
	3468.01.64.0000	4003474271798	084		8524.01.01.0000	4003474295671	023		8611.01.06.0400	4003474297149	144		7664.04.64.0000	4003474201443	069
	8468.01.32.0000	4003474069524	084		9524.08.01.0000	4003474295718	023	613	7613.03.64.0000	4003474111186	064	666	3666.01.64.0000	4003474295503	024
	8468.01.64.0000	4003474271804	084	540	9540.01.06.0600	4003474297736	090		7613.04.64.0000	4003474268781	064		6666.01.64.0000	4003474295572	024
472	8472.01.06.0000	4003474290386	082	543	9543.01.01.0000	4003474279473	037	621	4621.01.01.0044	4003474296425	133		8666.01.64.0000	4003474295510	024

Serie Series	Art-Nr. Item-No.	EAN-Nummer EAN-Number	Seite Page	Serie Series	Art-Nr. Item-No.	EAN-Nummer EAN-Number	Seite Page	Serie Series	Art-Nr. Item-No.	EAN-Nummer EAN-Number	Seite Page	Serie Series	Art-Nr. Item-No.	EAN-Nummer EAN-Number	Seite Page
666	9666.04.64.0000	4003474297514	024	705	3705.04.01.0000	4003474301686	010	759	9759.08.01.0000	4003474286907	038	806	7806.03.01.0000	4003474269894	119
669	4669.01.64.0000	4003474155920	128		3705.04.01.0CLC	4003474305721	010	770	3770.01.64.0000	4003474304595	022		7806.03.01.0044	4003474296203	137
	4669.01.64.0500	4003474155937	129		8705.03.01.0000	4003474302812	010		4770.01.64.0000	4003474301693	022		7806.05.01.0000	4003474274072	043
	7669.02.64.0000	4003474155944	129		8705.03.01.0CLC	4003474305738	010		7770.01.64.0000	4003474304625	022		9806.04.01.0000	4003474040240	119
	7669.03.64.0000	4003474155951	129	706	4706.01.88.0000	4003474297804	143		8770.01.64.0000	4003474304588	022		9806.04.01.0044	4003474296210	137
	7669.04.64.0000	4003474155968	128	707	4707.01.50.0000	4003474297484	143		9770.02.64.0000	4003474304601	022	807	3807.03.64.0000	4003474281650	086
	9669.04.64.0000	4003474146409	129	722	6722.01.64.0006	4003474209173	070		9770.04.64.0000	4003474304618	022	809	3809.01.01.0000	4003474301792	018
	9669.06.64.0000	4003474150147	128		7722.02.64.0006	4003474209203	070	777	3777.09.01.0000	4003474303338	035		4809.01.01.0000	4003474301730	018
670	9670.01.63.3344	4003474298887	138		7722.03.64.0006	4003474209234	070		8777.06.01.0000	4003474303345	035		7809.01.01.0000	4003474301716	018
671	9671.01.06.0000	4003474287102	096		8722.01.64.0006	4003474228334	081		9777.06.01.0000	4003474303406	035		8809.01.01.0000	4003474303161	018
	9671.01.06.0500	4003474287119	096	729	3729.01.01.0000	4003474306124	083		9777.09.01.0000	4003474303482	035		9809.01.01.0000	4003474301754	018
672	9672.01.63.0344	4003474298894	138		3729.03.01.0000	4003474306131	083	786	3786.01.54.0000	4003474303895	025	815	9815.04.54.0000	4003474301761	095
674	4674.04.01.0000	4003474302386	101		4729.01.01.0000	4003474306148	117		7786.01.54.0000	4003474306292	025	819	3819.01.50.0500	4003474296753	142
	9674.12.01.0000	4003474300412	101		7729.02.01.0000	4003474306155	117		8786.01.54.0000	4003474304229	025		3819.01.50.0900	4003474296746	142
	9674.16.01.0000	4003474302553	101		7729.04.01.0000	4003474306162	117		9786.06.54.0000	4003474303840	025		4819.01.50.0000	4003474296739	142
682	3682.01.01.0000	4003474259598	030		8729.01.01.0000	4003474306186	083	792	7792.06.01.0044	4003474296111	137	825	3825.01.54.0000	4003474274126	017
	3682.01.01.0500	4003474264493	030		9729.03.01.0000	4003474306261	117		9792.06.01.0300	4003474289373	118		4825.01.54.0000	4003474274133	017
	3682.01.64.0000	4003474279213	031		9729.03.01.0000	4003474306261	102		9792.06.01.0344	4003474296128	137		7825.01.54.0000	4003474274140	017
	7682.01.64.1200	4003474289496	031		9729.06.01.0000	4003474306179	117		9792.10.01.0000	4003474289410	118		7825.01.54.1000	4003474291208	017
	8682.01.01.0000	4003474259604	030		9729.06.01.0500	4003474306278	102	796	4796.01.32.0000	4003474282466	122		8825.01.54.0000	4003474274157	017
	8682.01.64.0000	4003474279855	031		9729.06.01.0500	4003474306278	117		7796.02.32.0000	4003474282480	122		9825.01.54.0000	4003474274560	017
693	9693.01.70.0300	4003474265629	092	740	4740.01.01.0000	4003474304090	114		9796.04.32.0000	4003474282503	122	830	3830.01.88.0400	4003474297095	143
	9693.01.70.0600	4003474265636	092		6740.01.01.0000	4003474259673	041		9796.06.32.0000	4003474282527	122		3830.01.88.0850	4003474297101	143
	9693.01.70.1200	4003474265643	092		7740.02.01.1000	4003474304106	114	802	1802.01.97.0050	4003474296791	147		4830.01.88.0000	4003474297118	143
	9693.01.70.5200	4003474286235	092		7740.04.01.0000	4003474302737	041		1802.01.97.0100	4003474296807	147	835	4835.01.54.0000	4003474304151	106
	9693.01.70.5300	4003474286211	092		7740.04.01.1000	4003474306223	114		8802.01.97.0000	4003474296814	147		4835.01.54.1000	4003474305974	106
	9693.01.70.5600	4003474286228	092		8740.01.01.0000	4003474302669	041	804	6804.01.64.0000	4003474152752	073	848	4848.01.54.0044	4003474296272	138
	9693.01.70.9000	4003474300177	092		9740.03.01.0000	4003474304120	114	805	4805.02.63.0000	4003474297354	145		7848.03.54.0044	4003474296135	138
703	4703.01.88.1200	4003474296968	144		9740.06.01.0000	4003474306063	114	806	4806.01.01.0000	4003474034843	119	854	9854.04.01.0000	4003474282626	104
	4703.01.88.1300	4003474296975	144	744	7744.03.64.0000	4003474195698	071		4806.01.01.0044	4003474296180	137	865	8865.02.32.0000	4003474156361	081
705	3705.03.01.0000	4003474301808	010	747	8747.02.01.0000	4003474196268	081		7806.02.01.0000	4003474034881	119		8865.02.64.0000	4003474156378	081
	3705.03.01.0CLC	4003474305714	010		8747.02.64.0000	400347419568	081		7806.02.01.0044	4003474296197	137	871	9871.04.01.0044	4003474296081	133





















Serie Series	Art-Nr. Item-No.	EAN-Nummer EAN-Number	Seite Page	Serie Series	Art-Nr. Item-No.	EAN-Nummer EAN-Number	Seite Page	Serie Series	Art-Nr. Item-No.	EAN-Nummer EAN-Number	Seite Page
876	9876.01.63.2644	4003474296715	139	997	3997.01.64.0000	4003474291550	045		4155	4003474297705	047
	9876.01.63.3344	4003474296722	139		6997.01.32.0000	4003474292595	045		4156	4003474297712	047
886	7886.05.64.0000	4003474237251	067		6997.01.64.0000	4003474291574	045				
889	7889.04.64.0000	4003474198170	064		7997.01.32.0000	4003474292601	046				
893	3893.03.54.0000	4003474304045	027		7997.01.64.0000	4003474292236	046				
	4893.01.54.0000	4003474306070	112		8997.01.32.0000	4003474292618	046				
	7893.02.54.0000	4003474306087	112		8997.01.64.0000	4003474291635	046				
	7893.04.54.1000	4003474302515	027		9997.01.06.0800	4003474306209	047				
	7893.06.54.0000	4003474305691	027		9997.01.32.0000	4003474292625	047				
	8893.01.54.0000	4003474304038	027		9997.01.64.0000	4003474291673	047				
	9893.03.54.0000	4003474304007	027		4111	4003474164281	045				
	9893.04.54.0000	4003474304021	112		4113	4003474291727	045				
	9893.06.54.0000	4003474306094	112		4114	4003474291734	045				
908	7908.01.01.0000	4003474304779	063		4116	4003474291758	045				
926	3926.01.08.2000	4003474305479	044		4117	4003474291765	046				
	6926.01.08.2000	4003474306230	044		4119	4003474291789	046				
	8926.01.08.2000	4003474305493	044		4120	4003474291796	046				
931	4931.02.64.0000	4003474158440	108		4122	4003474291819	046				
942	7942.04.64.0100	4003474183510	068		4123	4003474291826	047				
945	4945.01.50.0000	4003474297033	142		4125	4003474097053	047				
	4945.02.50.0000	4003474297040	142		4126	4003474291840	045				
946	3946.01.01.0000	4003474283043	034		4127	4003474291857	045				
	4946.03.01.0000	4003474282985	034		4128	4003474291864	046				
	4946.04.01.0000	4003474283067	034		4129	4003474291871	046				
	8946.01.01.0000	4003474283050	034		4130	4003474213712	047				
	9946.08.01.0000	4003474283074	034		4131	4003474213729	047				
952	4952.02.50.0000	4003474296845	142		4132	4003474213743	047				
973	9973.05.32.0000	4003474291123	049		4134	4003474291888	047				
	9973.05.64.0000	4003474283661	049		4151	4003474297668	046				
	9973.09.64.0000	4003474283678	049		4152	4003474297675	045				
988	7988.04.01.0100	4003474251660	068		4153	4003474297682	046				
997	3997.01.32.0000	4003474292588	045		4154	4003474297699	045				

Serie Series	Name Name	Serie Series	Name Name	Serie Series	Name Name	Serie Series	Name Name
354	ANGOLA	926	FILIZ	376	MILA	807	VANT
792	ANTIBES	472	FIN	475	MIRA	543	VELA
451	AQABA	141	FLAME	509	MISSION	871	VENETA
306	ARC	593	FORK	547	MODO	240	VERRE
225	ARIZONA	145	FREYA	394	MONTREAL	254	VILETA
623	ARTUS	740	FULTON	224	MORRIS	317	VITRO
703	ASTORIA	587	GALAX	276	NANCY	037	XENIA
360	ASTRO	664	GEORGIA	666	NAPA	611	YARD
729	ATKINS	445	GLAM	277	NERO	025	YON
886	ATLANTA	672	HALDEN	819	NEWARK	172	ZIBO
104	AUGUSTA	706	HALL	112	NEWTON	192	ZOON
759	AURORA	805	HARRIS	669	NINI		
945	AUSTIN	568	HOLLY	146	NOEMI		
270	AVA	893	HOOK	500	OASIS		
275	AVIGNON	786	HORTON	946	ORBIT		
404	BANKS	662	JADEN	510	ORLAND		
557	BENETT	658	JAY	670	OSLO		
854	BOIS	835	JIL	988	PARKER		
581	BRAEZ	419	KANPUR	621	PAX		
111	BRISTOL	017	KELTON	248	POINT		
952	BROOK	770	KENNETT	865	POP		
802	BRONX	060	KENT	747	PRESCOT		
830	BROOKLYN	540	KIANA	116	QUINCY		
423	CAJA	128	LACCHINO	272	REIMS		
796	CAMERON	090	LARA	120	ROMA		
448	CAMP	889	LAURIDS	671	RONDO		
545	CERES	369	LAVAL	744	SACRAMENTO		
494	CHATEAU	908	LAYTON	399	SANTA FEE		
195	CHLOE	592	LEE	722	SAVANNAH		
197	CHOLET	024	LEX	705	SEATTLE		
804	CLARA	244	LILIAN	161	SEGURA		
450	CLASS	693	LIV	162	SEGURA		
163	CLAY	343	LIVERPOOL	350	SILA		
513	CLAYTON	175	LOGAN	389	SKIN		
099	CLEO	624	LORE	707	SOHO		
234	COLMAR	848	LORIENT	501	SONETT		
377	COLO	468	LOU	524	SOREL		
850	COS	825	LOUVRE	117	SOUL		
416	CRUX	308	LUA	216	SPACE		
613	DARWIN	502	LUCE	102	SPHINX		
507	DAVIS	641	LUV	346	STEELE		
674	DELMAR	682	LUZ	622	SURI		
449	DEVENTER	806	MAAR	815	SURREY		
278	DORA	942	MADISON	628	SUTTER		
931	EDDY	204	MALI	596	TALAS		
093	ESTERA	876	MARA	997	TOULOUSE		
361	EVE	076	MARCO	809	TROIS		
067	EVERETT	446	MARQUIS	973	TROJA		
420	EVRY	245	MERAN	777	TROY		
514	FEY	313	MERCUR	006	TWIN		
637	FIGO	193	MIDU	625	VANNES		

						
01	Chrom	Chrome	Chrome	Cromo	Chrom	хромированный
02	Messing-gefärbt	Coloured brass	Imitation laiton	Latón-teñido	Mosiądz zafarbowany	цветная латунь
03	Bronze	Bronze	Bronze	Bronce	Brąz	бронзовый
06	Weiß	White	Blanc	Blanco	Biały	белый
08	Eiche hell	Light oak	Chêne clair	Roble claro	Jasny dąb	светлый дуб
09	Antik braun	Antique brown	Antique brune	Color tostado	Rdzawy	под ржавчину
10	Schwarz	Black	Noir	Negro	Czarny	чёрный
13	Gold-farbig	Gold coloured	Or coloré	Dorado	Złoty	бежевый
16	Gelb	Yellow	Jaune	Amarillo	Żółty	жёлтый
22	Messing modern	Brass modern	Laiton massif	Latón moderno	Mosiądz modny	современная латунь
24	Schwarz/Chrom	Black/Chrome	Noir/chrome	Negro/Cromo	Czarny/chrom	чёрный/хромированный
32	Messing-matt	Brass matt finished	Laiton mat	Latón-mate	Mosiądz matowy	матовая латунь
34	Weiß/Chrom	White/Chrome	Blanc/chrome	Blanco/Cromo	Biały/chrom	белый/хромированный
50	Grau	Grey	Gris	Gris	Szary	серый
54	Nickel-matt/Chrom	Nickel matt finished/Chrome	Nickel mat/chrome	Níquel-mate/cromo	Stal matowa/chrom	матовое железо/хром
63	Aluminium gebürstet	Aluminium brushed finished	En couleur nickel	Aluminio satinado	Aluminium	матовый алюминий
64	Nickel-matt	Nickel matt finished	Nickel mat	Níquel-mate	Stal matowa	матовое железо
70	Silber	Silver	Argent	Plata	Srebrny	серебряный
76	Nickel-matt eloxiert	Nickel-matt finished anodised	Nickel mat oxydé	Níquel mate, anodizado	Nikiel mat anodowany	анодированное матовое железо
77	Perlgrau gewischt	Wiped pearl grey	Gris perle brossé	Gris perla	Perłowo-szary szcztokowany	жемчужно-серый
88	Anthrazit	Dark grey	Gris foncé	Gris oscuro	Antracytowy	тёмно-серый
92	Creme rustikal	Creme rustic	Crème rustique	Crema	Kremowy rustykalny	кремовый
97	Edelstahl gebürstet	Stainless steel brushed	Acier brossé	Acero inoxidable cepillado	Stal szcztokowana	матовая высококачественная сталь

ZEICHENERKLÄRUNG / SIGNS & SYMBOLS

						
Technische Beschreibung	Technical Description	Description Technique	Descripcion Tecnica	Opis techniczny	Техническое описание	
	Durchmesser	Diameter	diamètre	diámetro	średnica	диаметр
	Höhe	Height	hauteur	Altura	wysokość	высота
	Breite	Width	largeur	anchura	szerokość	ширина
	Länge	Length	longueur	Longitud	długość	длина
	Ausladung	Outreach	portée	Alcance	zasięg	зона Достигаемости
	Stufenlos höhenverstellbar	Height infinitely adjustable	hauteur réglable sans cran	adjustable en altura sin	bezstopniowe przedstawianie wysokości	бесступенчатая регулировка по высоте
	Individuell kürzbar	Can be shortened as required	Raccourcissement individuel	acortable de manera individual	możliwość indywidualnego skrócenia	индивидуально укорачиваемая
	Handdimmer	Hand dimmer	variateur manuel	Reductor de luz de mano	ręczny regulator jasności światła	ручной регулятор яркости
	Fußdimmer	Foot dimmer	variateur à pied	Reductor de luz de pie	nożny regulator jasności światła	педадь регулятора яркости
	Ober- und Unterlicht	Upper and lower light	Lumière inférieure et supérieure	Luz superior e inferior	światło górne i dolne	верхний и нижний свет
	Schalter	Switch	interrupteur	interruptor	z włącznikiem	с выключателем
	Schwenkbar	Swivelling	orientable	girable	wysuwana	с возможностью перемещения
	Touch-It	Touch-It	Touch-It	Touch-It	Touch-It	сенсор
	Fernbedienung	Remote control	télécommande	mando a distancia	pilot	пульт управления
	Glühlampen Sockel E27	Incandescent Bulb E27 base	Ampoules douille E27	Bombillas base E27	Żarówki Cokół E27	лампь накаливания цоколь E27
	Allgebrauchslampe	General lighting service lamp	Ampoule multi-usage	Lámpara de uso universal	Żarówka do ogólnego użytku	лампа универсального применения
	Globelampe	Globe lamp	Ampoule à globe	Lámpara en forma de globo	Żarówka w formie kuli	шарообразная лампа
	Reflektorlampe R63	R63 reflector lamp	Ampoule à réflecteur R63	Lámpara de reflector R63	Żarówka projektorowa R63	рефлекторная лампа R63
	Reflektorlampe PAR 20/30	PAR 20/30 reflector lamp	Ampoule à réflecteur PAR 20/30	Lámpara de reflector PAR 20/30	Żarówka projektorowa PAR 20/30	рефлекторная лампа PAR 20/30

			
Glühlampen Sockel E14	Incandescent Bulb E14 base	Ampoules douille E14	
	Kerzenlampe	Candle lamp	Ampoule bougie
	Tropfenlampe Globelampe Ø 45mm	Round bulb lamp / Globe lamp Ø 45mm	Ampoule goutte / ampoule à globe Ø 45mm
	Reflektorlampe R50	R50 reflector lamp	Ampoule à réflecteur R50
	Halogen Lampen Hochvolt	Halogen lamps high volt	Ampoul halogène haute-tension
	Halogenlampe in Röhrenform Sockel E14 / E27	Tube-shaped halogen lamp E14 / E27 base	Ampoule halogène en forme de tube, Douille E14 / E27
	Stablampe 78 oder 118 mm lang, Sockel R7s	Electric torch 78 or 118 mm long, R7s base	Ampoule tige 78 ou 118 mm de long, Douille R7s
	Reflektorlampe Ø 50 mm, mit aluminiumbeschichtetem Reflektor Sockel GU10 / GZ10	Reflector lamp Ø 50 mm, with aluminiumcoated reflector GU10 / GZ10 base	Ampoule de réflecteur Ø 50 mm, à réflecteur recouvert d'aluminium, Douille GU10 / GZ10
	Halogenlampe „Halopin“ Sockel G9	„Halopin“ halogen lamp G9 base	Ampoule halogène „Halopin“ Douille G9
	Halogenlampe „Decopin“ Sockel G9	„Decopin“ halogen lamp G9 base	Ampoule halogène „Decopin“ Douille G9
	Halogen Lampen Niedervolt	Halogen lamps low volt	Ampoul halogène basse-tension
	Kaltlichtlampe Ø 50 mm, Sockel GU5,3	Cold light lamp Ø 50 mm, GU5,3 base	Ampoule à fluo-compacte Ø 50 mm, Douille GU5,3
	Kaltlichtlampe Ø 35 mm, Sockel GU4	Cold light lamp Ø 35 mm, GU4 base	Ampoule à fluo-compacte Ø 35 mm, Douille GU4
	Stiftsockellampe Sockel G4 / GY6,35	Pin base lamp G4 / GY6,35 base	Ampoule à douille tige, Douille G4 / GY6,35
	Ministar Sockel GY6,35	Ministar GY6,35 base	Ministar Douille GY6,35
	LED	LED	LED
	LED	LED	LED
	Reflektorlampe Sockel GU10	Reflector lamp GU10 base	Ampoule à réflecteur Douille GU10
	Sockel E14/E27	Base E14/E27	Douille E14/E27

KONTAKT / CONTACT

Gerne begrüßen wir Sie in unserem Showroom

Pleased to meet you in our showroom



Vertriebskontakt / Sales Contact

Möchten Sie den Vertriebsinnendienst erreichen verwenden Sie bitte die bekannte Durchwahl.

If you would like to get hold of the Sales Department please dial the known extension.

Service / Service
WOFI-Kundendienst
Postfach 3271
D - 59861 Meschede-Freienohl

phone +49 (0) 2903 449 449
fax +49 (0) 2903 449 459

email kundendienst@wofi.de
web www.wofi.de

Zentrale / Phone reception
Wortmann & Filz GmbH
Im Langel 6
D - 59872 Meschede-Freienohl

phone +49 (0) 2903 449 0
fax +49 (0) 2903 449 114

email info@wofi.de
web www.wofi.de

Oder besuchen Sie unsere Internetseite unter www.wofi.de

Or visit our website under www.wofi.de



WOFI Verwaltung



WOFI Logistik-Zentrum



WOFI[®]

Auf den folgenden Seiten gelangen Sie zu dem WOFI Sortiment
Please find the WOFI assortment on the following pages





Auf den folgenden Seiten gelangen Sie zu dem ACTION Sortiment
Please find the ACTION assortment on the following pages

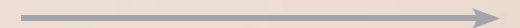

Lichtakzente

...light accents

2016



**INHALT
CONTENT**

Produktfamilien / Modern	Product families / Modern	4
Pendelleuchten	Pendants	13
Steh- und Tischleuchten	Floor and Table lamps	17
Standfluter	Uplighter	38
Wand- und Deckenleuchten	Wall and ceiling lights	40
Strahlerserien	Spotlight series	55
Außenleuchten	Outdoor Lights	68
Leuchtmittel	Illuminants	74
Index	Index	81

LED

Unsere LED-Leuchten und Leuchtmittel finden Sie auf folgenden Seiten:

You will find our LED lights and illuminants on the following pages:	12 – 15
	18 – 25
	31
	34 – 35
	38 – 39
	41 – 69



TECHNISCHE BESCHREIBUNG TECHNICAL DESCRIPTION

∅	Durchmesser	Diameter
↑	Höhe	Height
↔	Breite	Width
↗	Länge	Length
↔	Ausladung	Outreach
↕	Stufenlos höhenverstellbar	Height infinitely adjustable
👉	Handdimmer	Hand dimmer
👉	Fußdimmer	Foot dimmer
👉	Schalter	Switch
↻	schwenkbar	swivelling
👉	Touch-it	Touch-it
📡	Fernbedienung	Remote Control

Alle Maßangaben in diesem Katalog sind ca. Angaben.
Alle Maßangaben sind cm Angaben..

All measures in this catalogue are approximately.
All measures are in cm.



KENNZEICHNUNG DER ENERGIEEFFIZIENZ ENERGY EFFICIENCY LABELLING

Kennzeichnung durch den einzelnen Buchstaben bedeutet die jeweilige Energieeffizienzklasse des mitgelieferten Leuchtmittels bzw. der fest verbauten LED.

Individual letter stands for energy efficiency grade identification of the included bulb or mounted LED.



Alle austauschbaren, nicht fest verbauten Leuchtmittel können mit geeigneten Leuchtmitteln anderer Energieeffizienzklassen getauscht werden.

All exchangeable, not mounted bulbs can be replaced by suitable bulbs of different energy efficiency grade.

Folgendes Beispiel zeigt für welche Energieeffizienzklasse die jeweilige Leuchte geeignet ist sowie auch die erforderliche Fassung und die maximale Watt Angabe.

The following example shows for which energy efficiency grade the lighting fixture is suitable for as well as the needed socket and the maximum wattage of each lamp.

Beispiel example:

258 CRYSTAL

EAN-Nr. EAN-No.

Farbe Colour

Abmessungen Dimensions

Glas Glass

Zusatzinfos Extra-Information

Fit for LED

725809010000

4047494011217

Chrom Chrome

∩ 150 ↔ 120

7209, 7210, 7208

36 x Behang 36 x String

Fit for LED



geeignet für
suitable for
9 x E14 / max. 40W

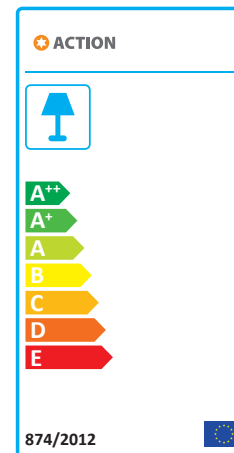



GLÜHLAMPEN SOCKEL E27
INCANDESCENT BULB E27 BASE



Allgebrauchslampe

General lighting service lamp



GLÜHLAMPEN SOCKEL E14
INCANDESCENT BULB E14 BASE



Kerzenlampe

Candle lamp



Tropfenlampe /
Globelampe Ø 45 mm

Round bulb lamp /
Globe lamp Ø 45 mm



HALOGEN LAMPEN HOCHVOLT
HALOGEN LAMPS HIGH VOLT



Stablampe 78 oder
118 mm lang, Sockel R7s

Electric torch 78 or 118 mm long,
R7s base



Reflektorlampe Ø 50 mm,
mit aluminium-beschichtetem
Reflektor Sockel GU10/GZ10

Reflector lamp Ø 50 mm,
with aluminiumcoated
reflector GU10/GZ10 base



Halogenlampe „Halopin“ Sockel G9

„Halopin“ halogen lamp G9 base



HALOGEN LAMPEN NIEDERVOLT
HALOGEN LAMPS LOW VOLT



Stiftsockellampe Sockel G4 / GY6,35

Pin base lamp G4 / GY6,35 base



ENERGIESPARENDE LEUCHTSTOFFLAMPEN
POWER SAVING FLUORESCENT LAMPS



Sockel E14 / E27

E14 / E27 base



Sockel GR10Q

GR10Q base



LED
LED



LED

LED



Reflektorlampe Sockel GU10

Reflector lamp GU10 base



Sockel E14/E27

E14 base / E27 base

1

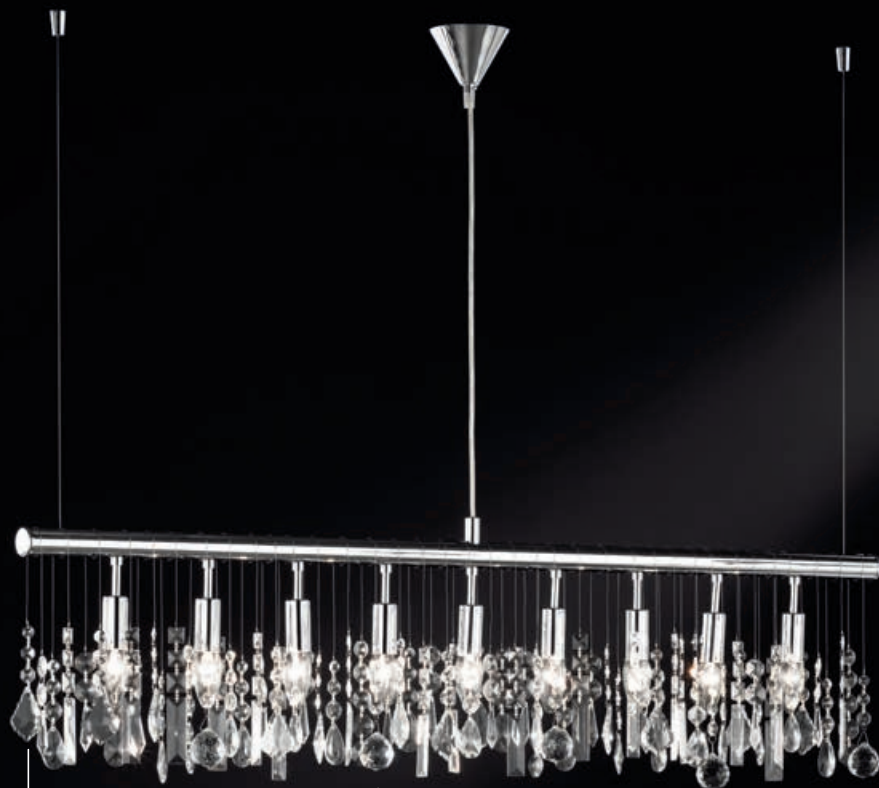

7208

7210

7209

2



7209

7210

7208

1

258 CRYSTAL

EAN-Nr. EAN-No.

Farbe Colour

Abmessungen Dimensions

Glas Glass

Zusatzinfos Extra-Information

725809010000

4047494011217

Chrom Chrome

1150 ↔ 120

7208, 7209, 7210

36 x Behang 36 x String
Fit for LEDA⁺⁺A⁺

A

B

C

D

E

 geeignet für
suitable for
9 x E14 /
max. 40 W

2

258 CRYSTAL

EAN-Nr. EAN-No.

Farbe Colour

Abmessungen Dimensions

Glas Glass

Zusatzinfos Extra-Information

725805010000

4047494010036

Chrom Chrome

1150 ↔ 80

7208, 7209, 7210

20 x Behang 20 x String
Fit for LEDA⁺⁺A⁺

A

B

C

D

E

 geeignet für
suitable for
5 x E14 /
max. 40 W

1

357 CARREE

EAN-Nr. EAN-No.
Farbe Colour

635701010000

4003474246420
Chrom Chrome

Abmessungen Dimensions
Glas Glass

Ø 31 ĩ 150
6545

Zusatzinfos Extra-Information

Fit for LED
24 x Behang 24 x String



geeignet für
suitable for
1 x E27 /
max. 60 W



2

357 CARREE

EAN-Nr. EAN-No.
Farbe Colour

935703010000

4003474246413
Chrom Chrome

Abmessungen Dimensions
Glas Glass

Ø 35 ĩ 26
6545

Zusatzinfos Extra-Information

Fit for LED
27 x Behang 27 x String



geeignet für
suitable for
3 x E14 /
max. 40 W



1



2



1



2



3



1

021 DAKOTA
 EAN-Nr. EAN-No.
 Farbe Colour
602101010300
 4260014065761
 Chrom Chrome

 Abmessungen Dimensions
 Zusatzinfos Extra-Information

 Ø 30 I 150
 Fit for LED

 geeignet für
 suitable for
 1 x E27 /
 max. 60W

2

021 DAKOTA
 EAN-Nr. EAN-No.
 Farbe Colour
602101010500
 4047494018889
 Chrom Chrome

 Abmessungen Dimensions
 Zusatzinfos Extra-Information

 Ø 50 I 150
 Fit for LED

 geeignet für
 suitable for
 1 x E27 /
 max. 60W

3

021 DAKOTA
 EAN-Nr. EAN-No.
 Farbe Colour
802101010300
 4260014065778
 Chrom Chrome

 Abmessungen Dimensions
 Zusatzinfos Extra-Information

 Ø 30 I 32
 Fit for LED

 geeignet für
 suitable for
 1 x E27 /
 max. 60W



1

264 TOLEDO	626401640300	A++	} geeignet für suitable for 1 x E27 / max. 60 W 
EAN-Nr. EAN-No.	4047494019015	A+	
Farbe Colour	Nickel-matt Nickel matt finished	A	
Abmessungen Dimensions	Ø 30 1150	B	
Zusatzinfos Extra-Information	Fit for LED	C	
		D	
		E	

2

264 TOLEDO	626401640400	A++	} geeignet für suitable for 1 x E27 / max. 60 W 
EAN-Nr. EAN-No.	4047494019022	A+	
Farbe Colour	Nickel-matt Nickel matt finished	A	
Abmessungen Dimensions	Ø 40 1150	B	
Zusatzinfos Extra-Information	Fit for LED	C	
		D	
		E	

3

264 TOLEDO	826401060200	A++	} geeignet für suitable for 1 x E14 / max. 40 W 
EAN-Nr. EAN-No.	4047494019107	A+	
Farbe Colour	Weiß White	A	
Abmessungen Dimensions	Ø 20	B	
Zusatzinfos Extra-Information	Fit for LED 	C	
		D	
		E	



1

2

1

328 COLLAGE**732803640000**

EAN-Nr. EAN-No.

4003474247793

Farbe Colour

Nickel-matt Nickel matt finished

Abmessungen Dimensions

1150 ↔ 69

Glas Glass

6465

Zusatzinfos Extra-Information

Fit for LED

A++

A+

A

B

C

D

E

geeignet für
suitable for
3 x E27 /
max. 60W



2

328 COLLAGE**632801640000**

EAN-Nr. EAN-No.

4003474247786

Farbe Colour

Nickel-matt Nickel matt finished

Abmessungen Dimensions

Ø 10 1150

Glas Glass

6465

Zusatzinfos Extra-Information

Fit for LED

A++

A+

A

B

C

D

E

geeignet für
suitable for
1 x E27 /
max. 60W



3

328 COLLAGE**832801640000**

EAN-Nr. EAN-No.

4003474247809

Farbe Colour

Nickel-matt Nickel matt finished

Abmessungen Dimensions

Ø 10 124

Glas Glass

6203

Zusatzinfos Extra-Information

Fit for LED 

A++

A+

A

B

C

D



E

geeignet für
suitable for
1 x E14 /
max. 40W



3



1

284 FLORENZ	328402061200	A++	} geeignet für suitable for 2 x E27 / max. 60 W 
EAN-Nr. EAN-No.	4003474245980	A+	
Farbe Colour	Weiß White	A	
Abmessungen Dimensions	Ø 20 1110	B	
Zusatzinfos Extra-Information	Fit for LED 	C	
		D	
		E	

2

284 FLORENZ	628401061200	A++	} geeignet für suitable for 1 x E27 / max. 60 W 
EAN-Nr. EAN-No.	4003474245997	A+	
Farbe Colour	Weiß White	A	
Abmessungen Dimensions	Ø 19 1150	B	
Zusatzinfos Extra-Information	Fit for LED	C	
		D	
		E	

3

284 FLORENZ	828401061160	A++	} geeignet für suitable for 1 x E14 / max. 60 W 
EAN-Nr. EAN-No.	4003474246000	A+	
Farbe Colour	Weiß White	A	
Abmessungen Dimensions	Ø 16 136	B	
Zusatzinfos Extra-Information	Fit for LED 	C	
		D	
		E	

1



2



3







1

003 FUTURA	600301010150	A++	} geeignet für suitable for 1 x E14 / max. 42 W 
EAN-Nr. EAN-No.	4003474267531	A+	
Farbe Colour	Chrom Chrome	A	
Abmessungen Dimensions	Ø 12 I150	B	
Glas Glass	6165	C	
Zusatzinfos Extra-Information	Fit for LED	D	
		E	

2

003 FUTURA	700304010150	A++	} geeignet für suitable for 4 x E14 / max. 42 W 
EAN-Nr. EAN-No.	4003474274041	A+	
Farbe Colour	Chrom Chrome	A	
Abmessungen Dimensions	→ 78 I150	B	
Glas Glass	6165	C	
Zusatzinfos Extra-Information	Fit for LED	D	
		E	

3

003 FUTURA	800301010150	A++	} geeignet für suitable for 1 x E14 / max. 42 W 
EAN-Nr. EAN-No.	4003474274058	A+	
Farbe Colour	Chrom Chrome	A	
Abmessungen Dimensions	Ø 12 I23	B	
Glas Glass	6165	C	
Zusatzinfos Extra-Information	Fit for LED 	D	
		E	

4

003 FUTURA	900301010200	A++	} geeignet für suitable for 1 x E27 / max. 60 W 
EAN-Nr. EAN-No.	4003474274300	A+	
Farbe Colour	Chrom Chrome	A	
Abmessungen Dimensions	Ø 20 I37	B	
Glas Glass	6166	C	
Zusatzinfos Extra-Information	Fit for LED	D	
		E	

5

003 FUTURA **600301010000**

EAN-Nr. EAN-No. 4003474263953

Farbe Colour Chrom Chrome

Abmessungen Dimensions Ø 28 I 47 I 150

Glas Glass 6170

Zusatzinfos Extra-Information Fit for LED

A++
A+
A
B
C
D
E

geeignet für suitable for 1 x E27 / max. 60 W

6

003 FUTURA **600301640000**

EAN-Nr. EAN-No. 4003474247922

Farbe Colour Nickel-matt Nickel matt finished

Abmessungen Dimensions Ø 28 I 47 I 150

Glas Glass 6170

Zusatzinfos Extra-Information Fit for LED

A++
A+
A
B
C
D
E

geeignet für suitable for 1 x E27 / max. 60 W

7

003 FUTURA **800301640000**

EAN-Nr. EAN-No. 4003474247915

Farbe Colour Nickel-matt Nickel matt finished

Abmessungen Dimensions Ø 28 I 49

Glas Glass 6170

Zusatzinfos Extra-Information Fit for LED

A++
A+
A
B
C
D
E

geeignet für suitable for 1 x E27 / max. 60 W

5



max. 150

6



max. 150

7





LED



LED



LED

1

436 MAINE

EAN-Nr. EAN-No.
Farbe Colour

743603640000

4003474277851
Nickel-matt Nickel matt finished

Leuchtmittel Lamp
Abmessungen Dimensions
Glas Glass
Zusatzinfos Extra-Information

3 x E14 / 4W / 3000K / 320lm incl. **A+**
↓ 150 → 80
6568 Ø 20

2

436 MAINE

EAN-Nr. EAN-No.
Farbe Colour

743602640000

4003474277844
Nickel-matt Nickel matt finished

Leuchtmittel Lamp
Abmessungen Dimensions
Glas Glass
Zusatzinfos Extra-Information

2 x E14 / 4W / 3000K / 320lm incl. **A+**
↓ 150 → 47
6568 Ø 20

3

436 MAINE

EAN-Nr. EAN-No.
Farbe Colour

843601640000

4003474277868
Nickel-matt Nickel matt finished

Leuchtmittel Lamp
Abmessungen Dimensions
Glas Glass
Zusatzinfos Extra-Information

1 x E14 / 4W / 3000K / 430lm incl. **A+**
↓ 40
6568 Ø 20



1

050 GWEN **705001640000**
 EAN-Nr. EAN-No. 4003474308067
 Farbe Colour Nickel-matt Nickel matt finished

Leuchtmittel Lamp  1 x LED / 30 W / 3000 K / 2000 lm incl. **A**
 Abmessungen Dimensions \downarrow 150 \leftrightarrow 88 \nearrow 10
 Zusatzinfos Extra-Information  

2

465 ALVA **746504640000**
 EAN-Nr. EAN-No. 4003474271385
 Farbe Colour Nickel-matt Nickel matt finished

Leuchtmittel Lamp  4 x LED / 3 W / 3000 K / 240 lm incl. **A+**
 Abmessungen Dimensions \downarrow 150 \leftrightarrow 102 \nearrow 6,5
 Glas Glass 6283
 Zusatzinfos Extra-Information 



LED



LED



1

345 VERSO

EAN-Nr. EAN-No.
Farbe Colour

Leuchtmittel Lamp
Abmessungen Dimensions
Glas Glass

734504640000

4003474286440
Nickel-matt Nickel matt finished

4 x LED / 4 W / 3000K / 300lm incl.
150 → 87
1422

A+

2

345 VERSO

EAN-Nr. EAN-No.
Farbe Colour

Leuchtmittel Lamp
Abmessungen Dimensions
Glas Glass
Zusatzinfos Extra-Information

734504640500

4003474289311
Nickel-matt Nickel matt finished

4 x LED / 4 W / 3000K / 300lm incl.
150 → 87
1422

A+

1

493 TOURS

749301640000

EAN-Nr. EAN-No.

4003474281568

Farbe Colour

Nickel-matt Nickel matt finished

Leuchtmittel Lamp

 1 x LED / 24 W / 3000 K / 1700lm incl. **A**

Abmessungen Dimensions

∩ 150 ↔ 106,4 ↗ 8

2

583 DIJON

758304640000

EAN-Nr. EAN-No.

4003474281858

Farbe Colour

Nickel-matt Nickel matt finished

Leuchtmittel Lamp

 4 x LED / 5 W / 3000 K / 400lm incl. **A+**

Abmessungen Dimensions

∩ 150 ↔ 80 ↗ 12

Glas Glass

1408

1

LED

2

LED

1



2



3



1

458 MAX

EAN-Nr. EAN-No.

Farbe Colour

Abmessungen Dimensions

Glas Glass

Zusatzinfos Extra-Information

745804640000

4047494018513

Nickel-matt Nickel matt finished

I150 → 98

6434

Fit for LED

A++

A+

A

B

C

D

E

geeignet für
suitable for
4 x E14 /
max. 60W

2

458 MAX

EAN-Nr. EAN-No.

Farbe Colour

Abmessungen Dimensions

Glas Glass

Zusatzinfos Extra-Information

645801640000

4047494018483

Nickel-matt Nickel matt finished

I150 Ø 8 → 12 ↗ 12

6434

Fit for LED

A++

A+

A

B

C

D

E

geeignet für
suitable for
1 x E14 /
max. 60W

3

458 MAX

EAN-Nr. EAN-No.

Farbe Colour

Abmessungen Dimensions

Glas Glass

Zusatzinfos Extra-Information

745803640000

4047494018506

Nickel-matt Nickel matt finished

I150 → 68

6434

Fit for LED

A++

A+

A

B

C

D

E

geeignet für
suitable for
3 x E14 /
max. 60W

1

885 ELYSSA

EAN-Nr. EAN-No.
Farbe Colour

Abmessungen Dimensions
Zusatzinfos Extra-Information

888501100000

4003474298283
Schwarz Black

Ø 20 I38
Fit for LED 



geeignet für
suitable for
1 x E27 /
max. 60W



Neu!
New!



1

1



LED

2



LED

1





530 LUND

EAN-Nr. EAN-No.
Farbe Colour

Leuchtmittel Lamp
Abmessungen Dimensions
Zusatzinfos Extra-Information

853001010250

4003474294360
Chrom Chrome

 1 x LED / 7W / 3000K / 420lm incl. **A**
 Ø 25  15
 3-Stufen-Dimmer 3 Step Dimmer

2





530 LUND

EAN-Nr. EAN-No.
Farbe Colour

Leuchtmittel Lamp
Abmessungen Dimensions
Zusatzinfos Extra-Information

853001010350

4003474294377
Chrom Chrome

 1 x LED / 12W / 3000K / 1000lm incl. **A**
 Ø 35  15
 3-Stufen-Dimmer 3 Step Dimmer

1

702 FAIR

EAN-Nr. EAN-No.
Farbe Colour

870201700000

4003474307541
Silber Silver

Leuchtmittel Lamp
Abmessungen Dimensions
Zusatzinfos Extra-Information

1 x LED / 7W / 4000K / 560lm incl. **A+**
I 38,5 ↗ 11 ↔ 33,5
3-Stufen-Dimmer 3 Step Dimmer
USB Anschluss USB port
Halterung für Smartphones/Tablets
Holder for mobile phones or tablets

2

469 TUBAC

EAN-Nr. EAN-No.
Farbe Colour

846901100000

4003474305431
Schwarz Black

Leuchtmittel Lamp
Abmessungen Dimensions
Zusatzinfos Extra-Information

1 x LED / 7W / 6500K / 520lm incl. **A+**
I 56 I 35
Touch-Dimmer touch dimmer
USB Ladeanschluss USB charging connection
Ladekabel für Steckdose recharger cable for socket
Farbtemperaturwechsler 3000 K -6500 K /
5 Steps 5 Steps

3

469 TUBAC

EAN-Nr. EAN-No.
Farbe Colour

846901060000

4003474305424
Weiß White

Leuchtmittel Lamp
Abmessungen Dimensions
Zusatzinfos Extra-Information

1 x LED / 7W / 6500K / 520lm incl. **A+**
I 56 I 35
Touch-Dimmer touch dimmer
USB Ladeanschluss USB charging connection
Ladekabel für Steckdose recharger cable for socket
Farbtemperaturwechsler 3000 K -6500 K /
5 Steps 5 Steps

1

Neu!
New!

LED



USB Anschluss/ USB port
Halterung für Smartphones/Tablets
Holder for mobile phones or tablets



2

Neu!
New!

USB Anschluss/ USB port



LED



3

Neu!
New!

USB Anschluss/ USB port



LED



1



LED

2



LED

3



LED

1

470 COLLO

EAN-Nr. EAN-No.
Farbe Colour

Leuchtmittel Lamp
Abmessungen Dimensions
Zusatzinfos Extra-Information

847001060000

4003474291895
Weiß White

1 x LED / 2W / 6500K / 75lm incl.
I 30 ← 30 ↗ 11

Steckernetzteil inkl. USB Powersupply incl. USB
Aufladbare Akku-Batterien Rechargeable battery

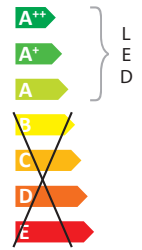

2

470 COLLO

EAN-Nr. EAN-No.
Farbe Colour

Leuchtmittel Lamp
Abmessungen Dimensions
Zusatzinfos Extra-Information

847001100000

4003474291901
Schwarz Black

1 x LED / 2W / 6500K / 75lm incl.
I 30 ← 30 ↗ 11

Steckernetzteil inkl. USB Powersupply incl. USB
Aufladbare Akku-Batterien Rechargeable battery

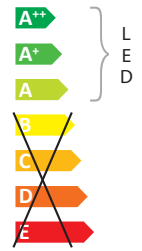

3

470 COLLO

EAN-Nr. EAN-No.
Farbe Colour

Leuchtmittel Lamp
Abmessungen Dimensions
Zusatzinfos Extra-Information

847001700000

4003474291918
Silber Silver

1 x LED / 2W / 6500K / 75lm incl.
I 30 ← 30 ↗ 11

Steckernetzteil inkl. USB Powersupply incl. USB
Aufladbare Akku-Batterien Rechargeable battery

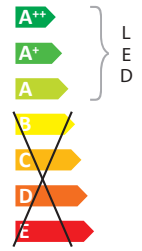

1



168 MIKA

816801060000

EAN-Nr. EAN-No.
Farbe Colour

4003474267166
Weiß White

Leuchtmittel Lamp
Abmessungen Dimensions
Zusatzinfos Extra-Information

 1 x LED / 2,9W / 3000 K / 230lm incl. **A**
I 34 → 10

2



168 MIKA

816801100000

EAN-Nr. EAN-No.
Farbe Colour

4003474267258
Schwarz Black

Leuchtmittel Lamp
Abmessungen Dimensions
Zusatzinfos Extra-Information

 1 x LED / 2,9W / 3000 K / 230lm incl. **A**
I 34 → 10

3



168 MIKA

816801700000

EAN-Nr. EAN-No.
Farbe Colour

4003474267265
Silber Silver

Leuchtmittel Lamp
Abmessungen Dimensions
Zusatzinfos Extra-Information

 1 x LED / 2,9W / 3000 K / 230lm incl. **A**
I 34 → 10

1

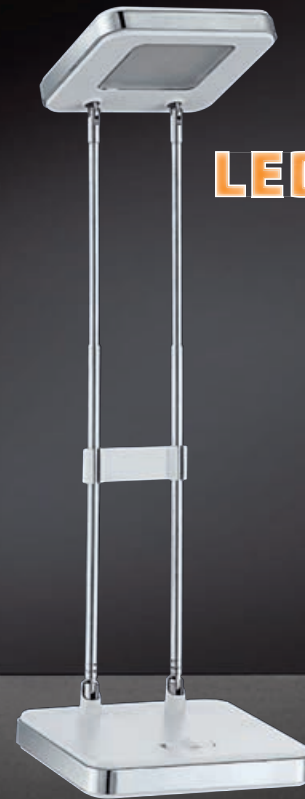

LED

3



LED

2



LED



1

866 ARCOS

EAN-Nr. EAN-No.
Farbe Colour

Leuchtmittel Lamp
Abmessungen Dimensions
Zusatzinfos Extra-Information

286601640000

4047494018322
Nickel-matt Nickel matt finished

1 x GU10 / 1 W / 4500 K / 60 lm incl. **A++**
I 40
40

2

772 COTTO

EAN-Nr. EAN-No.
Farbe Colour

Leuchtmittel Lamp
Abmessungen Dimensions
Zusatzinfos Extra-Information

277201640000

4047494018339
Nickel-matt Nickel matt finished

1 x LED / 2,2 W / 3000 K / 170 lm incl. **A+**
I 40
40

3

717 CORBY

EAN-Nr. EAN-No.
Farbe Colour

Leuchtmittel Lamp
Abmessungen Dimensions
Zusatzinfos Extra-Information

871701290000

4047494011965
Blau Blue

1 x E27 / 15 W / 2700 K / 900 lm incl. **A**
I 75
60

4

717 CORBY

EAN-Nr. EAN-No.
Farbe Colour

Leuchtmittel Lamp
Abmessungen Dimensions
Zusatzinfos Extra-Information

871701100000

4047494011972
Schwarz Black

1 x E27 / 15 W / 2700 K / 900 lm incl. **A**
I 75
60

5

717 CORBY

EAN-Nr. EAN-No.
Farbe Colour

Leuchtmittel Lamp
Abmessungen Dimensions
Zusatzinfos Extra-Information



871701700000

4047494011989
Silber Silver

1 x E27 / 15 W / 2700 K / 900 lm incl. **A**
I 75
60



1

901 FLEX **890112100000**
 EAN-Nr. EAN-No. 4047494018308
 Farbe Colour Schwarz Black

Leuchtmittel Lamp  1 x LED / 3,7 W / 3000 K / 200 lm incl. **A**
 Abmessungen Dimensions \bar{I} 40 \bar{H} 30
 Zusatzinfos Extra-Information 



2

903 FLEX **290312100000**
 EAN-Nr. EAN-No. 4047494018285
 Farbe Colour Schwarz Black

Leuchtmittel Lamp  1 x LED / 3,7 W / 3000 K / 200 lm incl. **A**
 Abmessungen Dimensions \bar{I} 40 \bar{H} 40
 Zusatzinfos Extra-Information 



3

902 FLEX **890212060000**
 EAN-Nr. EAN-No. 4047494018315
 Farbe Colour Weiß White

Leuchtmittel Lamp  1 x LED / 3,7 W / 3000 K / 200 lm incl. **A**
 Abmessungen Dimensions \bar{I} 40 \bar{H} 30
 Zusatzinfos Extra-Information 

4

903 FLEX **290312060000**
 EAN-Nr. EAN-No. 4047494018278
 Farbe Colour Weiß White

Leuchtmittel Lamp  1 x LED / 3,7 W / 3000 K / 200 lm incl. **A**
 Abmessungen Dimensions \bar{I} 40 \bar{H} 40
 Zusatzinfos Extra-Information 

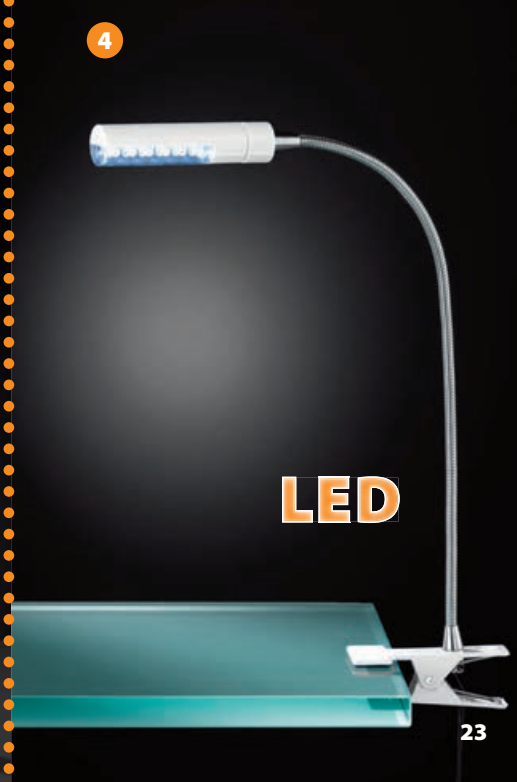
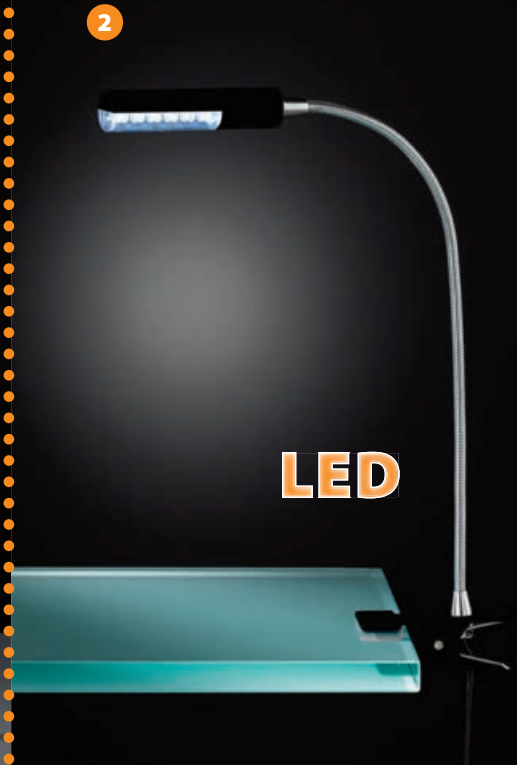

1



LED

2



LED

3



4



5



LED

6



LED

1

570 HOLM

EAN-Nr. EAN-No.
Farbe Colour

857001060000

4003474274317
Weiß White

Leuchtmittel Lamp
Abmessungen Dimensions
Zusatzinfos Extra-Information

1 x LED / 2,4 W / 3000 K / 260 lm incl. **A**
Ø 16 I 41,5

2

570 HOLM

EAN-Nr. EAN-No.
Farbe Colour

857001100000

4003474274324
Schwarz Black

Leuchtmittel Lamp
Abmessungen Dimensions
Zusatzinfos Extra-Information

1 x LED / 2,4 W / 3000 K / 260 lm incl. **A**
Ø 16 I 41,5

3

571 REYK

EAN-Nr. EAN-No.
Farbe Colour

857101060000

4003474274355
Weiß White

Abmessungen Dimensions
Zusatzinfos Extra-Information

Ø 14 I 35
Fit for LED

A++
A+
A
B
C
D
E

geeignet für
suitable for
1 x E27 /
max. 15 W

4

571 REYK

EAN-Nr. EAN-No.
Farbe Colour

857101100000

4003474274362
Schwarz Black

Abmessungen Dimensions
Zusatzinfos Extra-Information

Ø 14 I 35
Fit for LED

A++
A+
A
B
C
D
E

geeignet für
suitable for
1 x E27 /
max. 15 W

5

572 NEVIS

EAN-Nr. EAN-No.
Farbe Colour

857201060000

4003474274393
Weiß White

Leuchtmittel Lamp
Abmessungen Dimensions
Zusatzinfos Extra-Information

1 x LED / 1,5 W / 3000 K / 210 lm incl. **A+**
Ø 14 I 35

6

572 NEVIS

EAN-Nr. EAN-No.
Farbe Colour

857201100000

4003474274409
Schwarz Black

Leuchtmittel Lamp
Abmessungen Dimensions
Zusatzinfos Extra-Information

1 x LED / 1,5 W / 3000 K / 210 lm incl. **A+**
Ø 14 I 35

1

349 JOS **234901109000**
 EAN-Nr. EAN-No. 4003474262406
 Farbe Colour Schwarz Black

 Leuchtmittel Lamp 1 x E14 / 4W / 3000K / 270lm incl. **A+**
 Abmessungen Dimensions \downarrow 35 \rightarrow 16
 Schirm Shade 6100
 Zusatzinfos Extra-Information 

2

349 JOS **234901509000**
 EAN-Nr. EAN-No. 4003474262437
 Farbe Colour Grau Grey

 Leuchtmittel Lamp 1 x E14 / 4W / 3000K / 270lm incl. **A+**
 Abmessungen Dimensions \downarrow 35 \rightarrow 16
 Schirm Shade 6100
 Zusatzinfos Extra-Information 

3

349 JOS **834901109000**
 EAN-Nr. EAN-No. 4003474262451
 Farbe Colour Schwarz Black

 Leuchtmittel Lamp 1 x E14 / 4W / 3000K / 270lm incl. **A+**
 Abmessungen Dimensions \downarrow 42 \rightarrow 16
 Schirm Shade 6100
 Zusatzinfos Extra-Information 

4

349 JOS **834901509000**
 EAN-Nr. EAN-No. 4003474262482
 Farbe Colour Grau Grey

 Leuchtmittel Lamp 1 x E14 / 4W / 3000K / 270lm incl. **A+**
 Abmessungen Dimensions \downarrow 42 \rightarrow 16
 Schirm Shade 6100
 Zusatzinfos Extra-Information 

1



LED

2



LED

3



LED

4

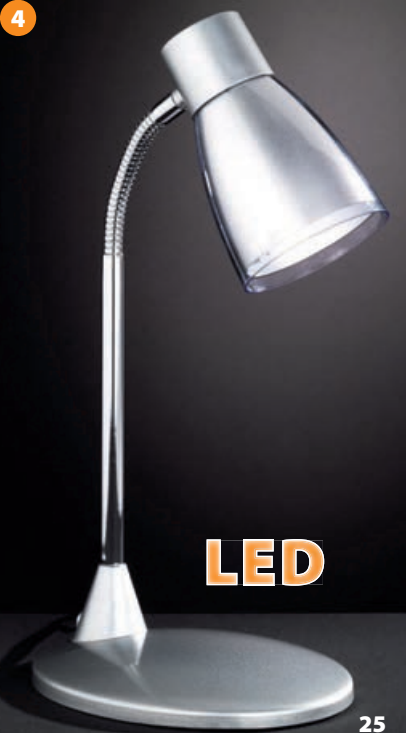

LED

1



1

141 FLAME

EAN-Nr. EAN-No.

Farbe Colour

Abmessungen Dimensions

Glas Glass

Zusatzinfos Extra-Information

814101640500

4260014066911

Nickel-matt Nickel matt finished

Ø 11 I 19,5

7324 Ø10 I 11,5

👆 3 Stufen Touch 3 Step touch

A++

A+

A

B

C

D

E

geeignet für
suitable for
1 x E14 /
max. 60 W

2

141 FLAME

EAN-Nr. EAN-No.

Farbe Colour

Abmessungen Dimensions

Glas Glass

Zusatzinfos Extra-Information

814101320500

4047494016847

Messing-matt Brass matt finished

Ø 11 I 19,5

7324 Ø10 I 11,5

👆 3 Stufen Touch 3 Step touch

A++

A+

A

B

C

D

E

geeignet für
suitable for
1 x E14 /
max. 60 W

2



1

322 LANETT	832201900000		geeignet für suitable for 1 x E14 / max. 40 W
EAN-Nr. EAN-No.	4003474305998		
Farbe Colour	Elfenbeinfarbig Ivory colored		
Abmessungen Dimensions	139 → 16		
Zusatzinfos Extra-Information	Fit for LED		

2

322 LANETT	832201100000		geeignet für suitable for 1 x E14 / max. 40 W
EAN-Nr. EAN-No.	4003474305356		
Farbe Colour	Black Schwarz		
Abmessungen Dimensions	139 → 16		
Zusatzinfos Extra-Information	Fit for LED		

3

322 LANETT	832201700000		geeignet für suitable for 1 x E14 / max. 40 W
EAN-Nr. EAN-No.	4003474305363		
Farbe Colour	Silber Silver		
Abmessungen Dimensions	139 → 16		
Zusatzinfos Extra-Information	Fit for LED		



1



2



3

LED



4



1

307 LOFT
 EAN-Nr. EAN-No. 4047494018353
 Farbe Colour Nickel-matt Nickel matt finished
 Abmessungen Dimensions Ø 9 I 33
 Glas Glass 6200 Ø 9 I 17
 Zusatzinfos Extra-Information 3 Stufen Touch 3 Step touch



geeignet für
 suitable for
 1 x E14 /
 max. 60 W

2

307 LOFT
 EAN-Nr. EAN-No. 4047494018346
 Farbe Colour Nickel-matt Nickel matt finished
 Abmessungen Dimensions Ø 10 I 17,5
 Glas Glass 6199 Ø 9 I 15
 Zusatzinfos Extra-Information 3 Stufen Touch 3 Step touch



geeignet für
 suitable for
 1 x E14 /
 max. 60 W

3

307 LOFT
 EAN-Nr. EAN-No. 4003474289656
 Farbe Colour Nickel-matt Nickel matt finished
 Leuchtmittel Lamp 1 x E14 / 4 W / 3000 K / 320lm incl.
 Abmessungen Dimensions Ø 10 I 17,5
 Glas Glass 6199 Ø 9 I 15
 Zusatzinfos Extra-Information

4

579 BARNEY
 EAN-Nr. EAN-No. 4047494017981
 Farbe Colour Nickel-matt Nickel matt finished
 Leuchtmittel Lamp 1 x G9 / 28 W / 2800 K / 370 lm incl.
 Abmessungen Dimensions Ø 15 I 22
 Glas Glass 6036 Ø 14,2 I 9,9
 Zusatzinfos Extra-Information 3-Stufen-Dimmer 3 Step Dimmer

1

575 AMBER

857501640000

EAN-Nr. EAN-No.

4003474273273

Farbe Colour

Nickel-matt Nickel matt finished

Leuchtmittel Lamp

1 x E14 / 3 W / 3000 K / 260 lm incl. **A+**

Abmessungen Dimensions

Ø 14 I 29

Glas Glass

6176 Ø13,9 I 7,8

Zusatzinfos Extra-Information

 Fit for LED

2

342 PLUTO

834201640120

EAN-Nr. EAN-No.

4003474244990

Farbe Colour

Nickel-matt Nickel matt finished

Abmessungen Dimensions

Ø 12 I 16

Zusatzinfos Extra-Information

 Fit for LED



geeignet für
suitable for
1 x E14 /
max. 9W

3

342 PLUTO

834201010120

EAN-Nr. EAN-No.

4003474248844

Farbe Colour

Chrom Chrome

Abmessungen Dimensions

Ø 12 I 16

Zusatzinfos Extra-Information

 Fit for LED



geeignet für
suitable for
1 x E14 /
max. 9W

1



LED

2



3



1



Neu!

New!

LED

2



3



4



1

478 VARESE

847801640000

EAN-Nr. EAN-No.

4003474300238

Farbe Colour

Nickel-matt Nickel matt finished

Leuchtmittel Lamp

1 x LED / 5 W / 3000 K / 420 lm incl. **A+**

Abmessungen Dimensions

∩ 27 ∅ 12

Glas Glass

3064 ∅ 12 ∩ 9,4

Zusatzinfos Extra-Information

Fit for LED

2

092 METZ

809201640000

EAN-Nr. EAN-No.

4003474281742

Farbe Colour

Nickel-matt Nickel matt finished

Abmessungen Dimensions

∅ 22,5 ∩ 30

Glas Glass

6608 ∅ 22,5 ∩ 8,5

Zusatzinfos Extra-Information

Fit for LED



geeignet für suitable for 1 x E14 / max. 40 W



3

444 PROVO

844401320000

EAN-Nr. EAN-No.

4003474293080

Farbe Colour

Messing-matt Brass matt finished

Abmessungen Dimensions

∅ 14,5 ∩ 32,5

Glas Glass

3019 ∅ 14,5

Zusatzinfos Extra-Information

Fit for LED



geeignet für suitable for 1 x E14 / max. 28 W



4

444 PROVO

844401640000

EAN-Nr. EAN-No.

4003474293097

Farbe Colour

Nickel-matt Nickel matt finished

Abmessungen Dimensions

∅ 14,5 ∩ 32,5

Glas Glass

3019 ∅ 14,5

Zusatzinfos Extra-Information

Fit for LED



geeignet für suitable for 1 x E14 / max. 28 W



1

654 ANIQUE **865401320000**

EAN-Nr. EAN-No. 4003474280912
 Farbe Colour Messing-matt Brass matt finished

Leuchtmittel Lamp  1 x LED / 5W / 3000K / 320lm incl. **A**

Abmessungen Dimensions \varnothing 13 I 30
 Glas Glass 6525 \varnothing 13 I 11,5

Zusatzinfos Extra-Information 

2

654 ANIQUE **865401640000**

EAN-Nr. EAN-No. 4003474280905
 Farbe Colour Nickel-matt Nickel matt finished

Leuchtmittel Lamp  1 x LED / 5W / 3000K / 320lm incl. **A**

Abmessungen Dimensions \varnothing 13 I 30
 Glas Glass 6525 \varnothing 13 I 11,5

Zusatzinfos Extra-Information 

3

474 MORLEY **847401640000**

EAN-Nr. EAN-No. 4003474277707
 Farbe Colour Nickel-matt Nickel matt finished

Abmessungen Dimensions \varnothing 17,5 I 33
 Glas Glass 6502 \varnothing 17 I 9,5

Zusatzinfos Extra-Information  Fit for LED

A++
A+
A
B
C
D
E

geeignet für suitable for 1 x E14 / max. 46 W 

4

474 MORLEY **847401320000**

EAN-Nr. EAN-No. 4003474277691
 Farbe Colour Messing-matt Brass matt finished

Abmessungen Dimensions \varnothing 17,5 I 33
 Glas Glass 6502 \varnothing 17 I 9,5

Zusatzinfos Extra-Information  Fit for LED

A++
A+
A
B
C
D
E

geeignet für suitable for 1 x E14 / max. 46 W 





1

383 OKTO	838301020000	A++	} geeignet für suitable for 1 x E14 / max. 60 W
EAN-Nr. EAN-No.	4047494011316	A+	
Farbe Colour	Messing-gefärbt Coloured brass	A	
Abmessungen Dimensions	Ø 25 I 36	B	
Glas Glass	7052 Ø 25 I 9,4	C	
Zusatzinfos Extra-Information	3 Stufen Touch 3 Step touch	D	
		E	

2

383 OKTO	838301640000	A++	} geeignet für suitable for 1 x E14 / max. 60 W
EAN-Nr. EAN-No.	4260014063972	A+	
Farbe Colour	Nickel-matt Nickel matt finished	A	
Abmessungen Dimensions	Ø 25 I 36	B	
Glas Glass	7052 Ø 25 I 9,4	C	
Zusatzinfos Extra-Information	3 Stufen Touch 3 Step touch	D	
		E	

3

383 OKTO	838301645000	A++	} geeignet für suitable for 1 x E14 / max. 60 W
EAN-Nr. EAN-No.	4047494010531	A+	
Farbe Colour	Nickel-matt Nickel matt finished	A	
Abmessungen Dimensions	Ø 25 I 36	B	
Glas Glass	7048 Ø 25 I 9,4	C	
Zusatzinfos Extra-Information	3 Stufen Touch 3 Step touch	D	
		E	

4

383 OKTO	838301320000	A++	} geeignet für suitable for 1 x E14 / max. 60 W
EAN-Nr. EAN-No.	4047494010548	A+	
Farbe Colour	Messing-matt Brass matt finished	A	
Abmessungen Dimensions	Ø 25 I 36	B	
Glas Glass	7052 Ø 25 I 9,4	C	
Zusatzinfos Extra-Information	3 Stufen Touch 3 Step touch	D	
		E	

1

324 CESENA	832401100000	A++
EAN-Nr. EAN-No.	4003474256757	A+
Farbe Colour	Schwarz Black	A
Abmessungen Dimensions	Ø 14 I 32	B
Schirm Shade	7827 Ø 14 I 13	C
Zusatzinfos Extra-Information	Fit for LED	D
		E

geeignet für suitable for
1 x E14 / max. 42 W

2

324 CESENA	832401500000	A++
EAN-Nr. EAN-No.	4003474256740	A+
Farbe Colour	Grau Grey	A
Abmessungen Dimensions	Ø 14 I 32	B
Schirm Shade	7830 Ø 14 I 13	C
Zusatzinfos Extra-Information	Fit for LED	D
		E

geeignet für suitable for
1 x E14 / max. 42 W

3

324 CESENA	832401510000	A++
EAN-Nr. EAN-No.	4003474256764	A+
Farbe Colour	Hellbraun Light brown	A
Abmessungen Dimensions	Ø 14 I 32	B
Schirm Shade	7831 Ø 14 I 13	C
Zusatzinfos Extra-Information	Fit for LED	D
		E

geeignet für suitable for
1 x E14 / max. 42 W

4

324 CESENA	832401060000	A++
EAN-Nr. EAN-No.	4003474257549	A+
Farbe Colour	Weiß White	A
Abmessungen Dimensions	Ø 14 I 32	B
Schirm Shade	7826 Ø 14 I 13	C
Zusatzinfos Extra-Information	Fit for LED	D
		E

geeignet für suitable for
1 x E14 / max. 42 W



1

LED

2

LED

Neu!

New!

1

190 ZEN

EAN-Nr. EAN-No.

Farbe Colour

Leuchtmittel Lamp



Abmessungen Dimensions

Zusatzinfos Extra-Information

319001640000

4003474283647

Nickel-matt Nickel matt finished

 1 x LED / 21,6W / 3000K / 1500lm incl. **A**
 150  87  25



2

708 LAUREL

EAN-Nr. EAN-No.

Farbe Colour

Leuchtmittel Lamp





Abmessungen Dimensions

Zusatzinfos Extra-Information

370801700000

4003474307534

Silber Silver

 1 x LED / 4W / 4000K / 420lm incl. **A+**
 130  24  24



mit Leselupe with magnifying lense



1







071 NOIS

EAN-Nr. EAN-No.
Farbe Colour

307101640000

4003474283388
Nickel-matt Nickel matt finished

Leuchtmittel Lamp
Abmessungen Dimensions
Glas Glass
Zusatzinfos Extra-Information

 1 x LED / 5W / 3000K / 380lm incl. **A+**
 148,5  39
 1410  9  17,4

2







071 NOIS

EAN-Nr. EAN-No.
Farbe Colour

307102640000

4003474283395
Nickel-matt Nickel matt finished

Leuchtmittel Lamp
Abmessungen Dimensions
Glas Glass
Zusatzinfos Extra-Information

 2 x LED / 5W / 3000K / 380lm incl. **A+**
 160  61
 1410  9  17,4

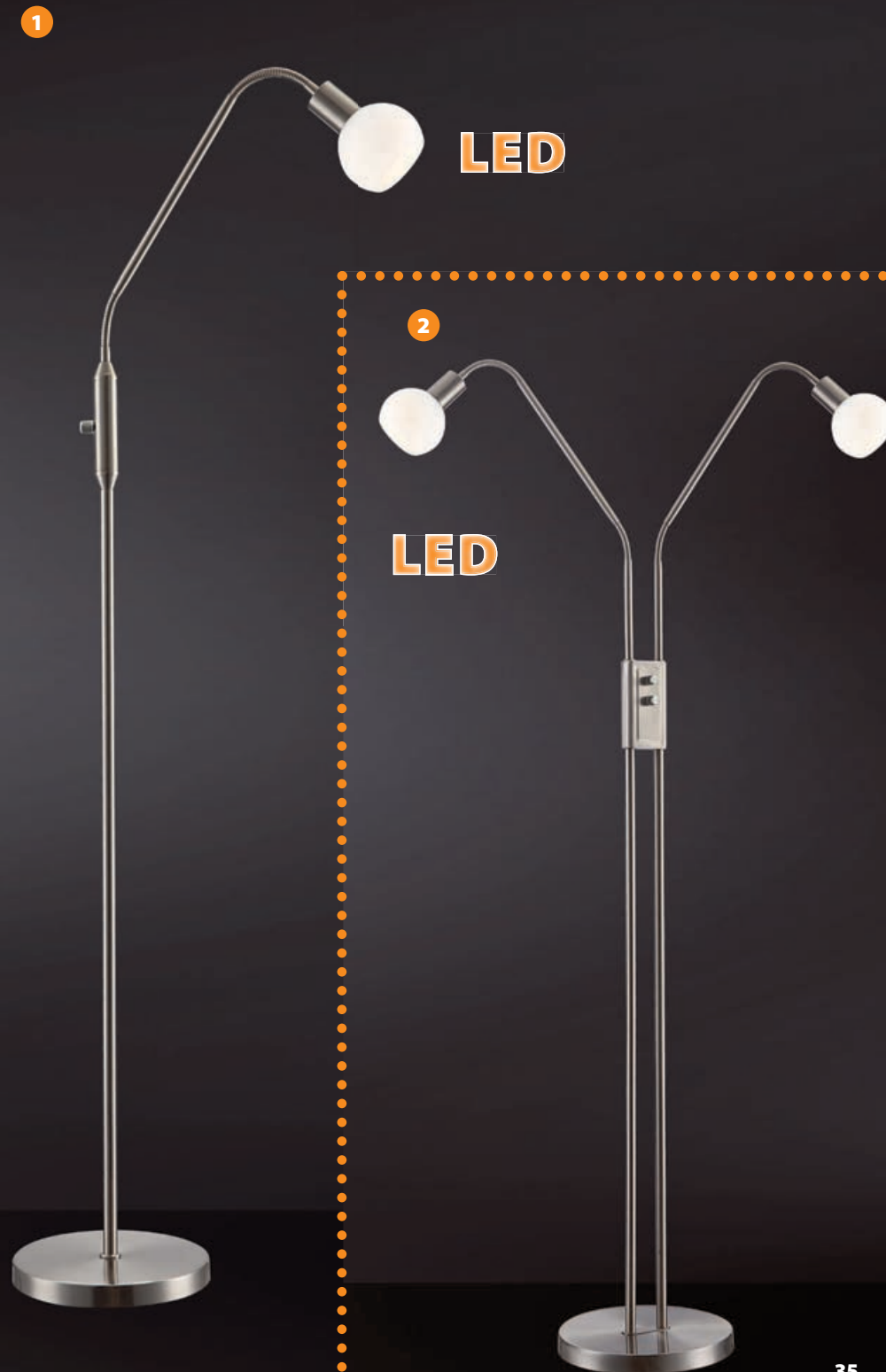



1

294 BOW

EAN-Nr. EAN-No.

Farbe Colour

Abmessungen Dimensions

Glas Glass

Zusatzinfos Extra-Information

329401010000

4260014061695

Chrom Chrome

Fuß Base Ø 35 I 195 H 170

3120 Kunstoffschilder Ø 40

Plastic shade

Fit for LED

A++

A+

A

B



C

D

E

geeignet für
suitable for
1 x E27 /
max. 60 W

1

709 WIDNES	370905010000	A++	} geeignet für suitable for 5 x E14 / max. 40 W 
EAN-Nr. EAN-No.	4260014061497	A+	
Farbe Colour	Chrom Chrome	A	
		B	
		C	
		D	
		E	
Abmessungen Dimensions	I 225 H 100		
Zusatzinfos Extra-Information	 Fit for LED		

2

084 SANDER	308401010000	A++	} geeignet für suitable for 1 x E27 / max. 70 W 
EAN-Nr. EAN-No.	4003474260112	A+	
Farbe Colour	Chrom Chrome	A	
		B	
		C	
		D	
		E	
Abmessungen Dimensions	Ø 30 I 170 H 112		
Glas Glass	3125 Kunststoffschild Plastic shade	Ø 30	
Zusatzinfos Extra-Information	 Fit for LED		

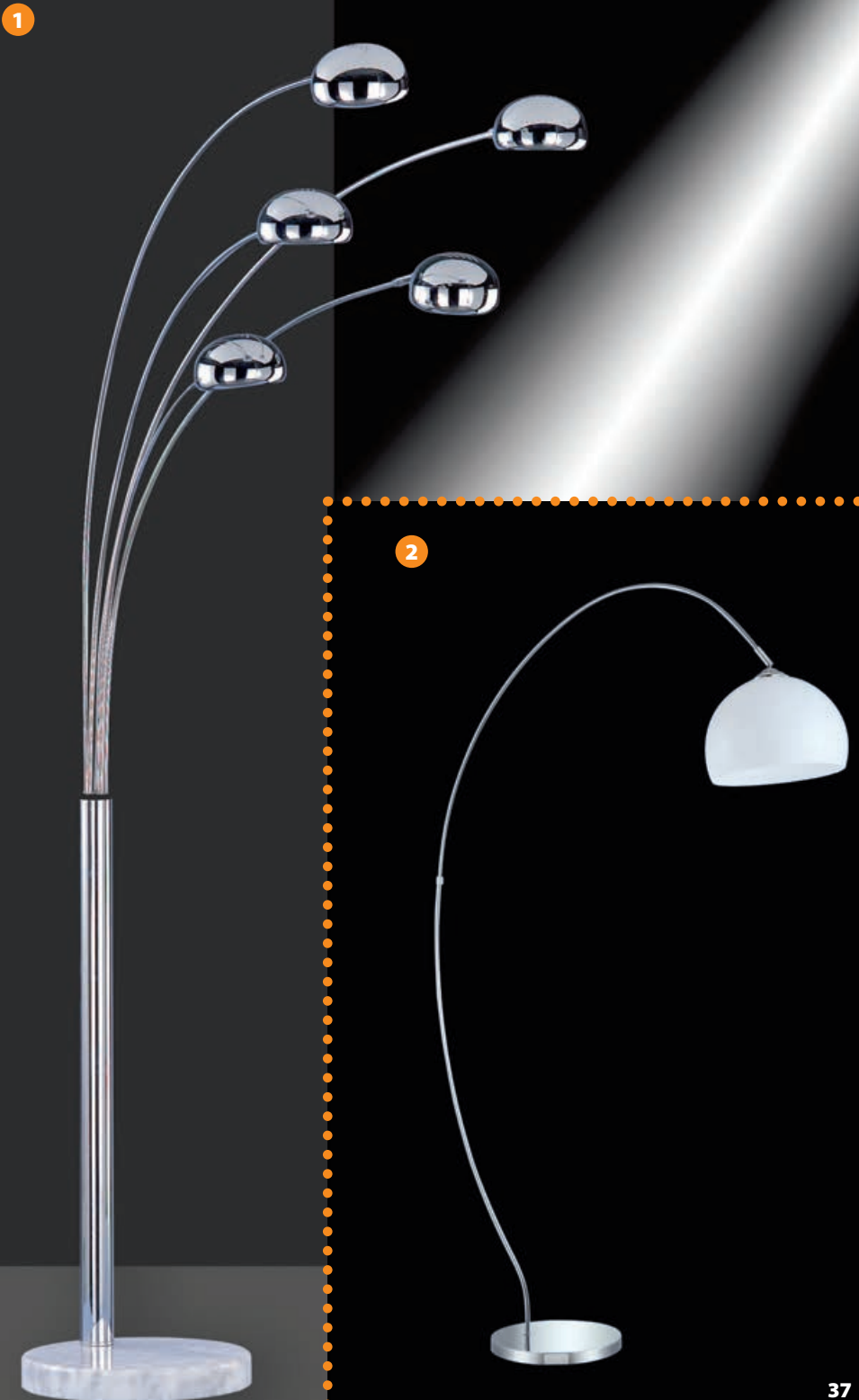

6610

1

7012

LED

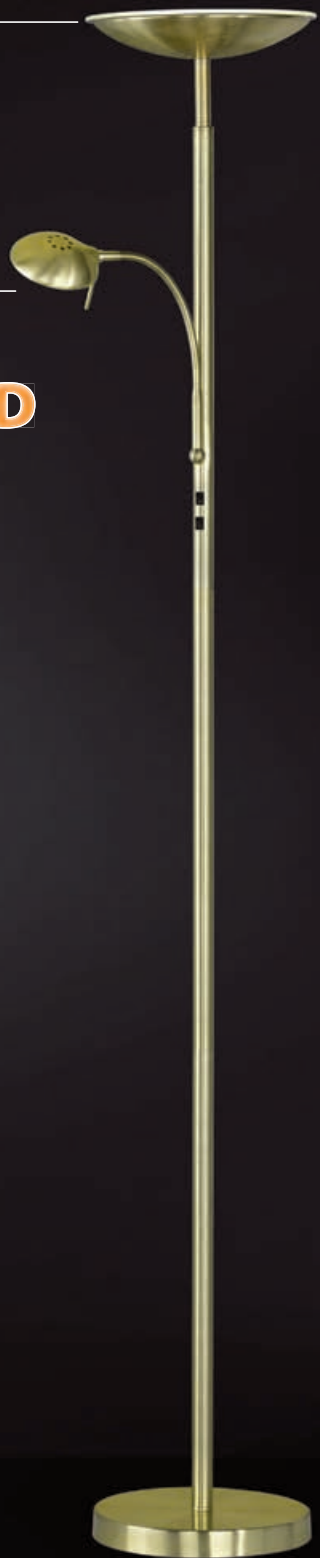

6610

2

7012

LED



STANDFLUTER UPLIGHTER

1

746 KENTO

EAN-Nr. EAN-No.
Farbe Colour

374602320000

4003474290089
Messing-matt Brass matt finished

Leuchtmittel Lamp

 1 x LED / 18W / 2700K / 1600 lm incl. **A**

Abmessungen Dimensions

 1 x LED / 5W / 2700K / 400 lm incl. **A+**

Glas Glass

180
6610, 7012

Zusatzinfos Extra-Information



2

746 KENTO

EAN-Nr. EAN-No.
Farbe Colour

374602640000

4003474286457
Nickel-matt Nickel matt finished

Leuchtmittel Lamp

 1 x LED / 18W / 3000K / 1600 lm incl. **A**

Abmessungen Dimensions

 1 x LED / 5W / 3000K / 400 lm incl. **A+**

Glas Glass

180
6610, 7012

Zusatzinfos Extra-Information



1

367 MONZA

336702640000

EAN-Nr. EAN-No.

4003474281643

Farbe Colour

Nickel-matt Nickel matt finished

Leuchtmittel Lamp

 1 x LED / 20W / 3000K / 1600lm incl. **A**

 1 x LED / 7W / 3000K / 500lm incl. **A**

Abmessungen Dimensions

Ø 35 I 180

Glas Glass

7941, 7942

Zusatzinfos Extra-Information



2

534 BERIT

353402640000

EAN-Nr. EAN-No.

4003474277684

Farbe Colour

Nickel-matt Nickel matt finished

Leuchtmittel Lamp

 1 x LED / 16W / 3000K / 1700lm incl. **A+**

 1 x LED / 4,5W / 3000K / 480lm incl. **A+**

Abmessungen Dimensions

I 180

Glas Glass

6563, 6564, 6566

Zusatzinfos Extra-Information



1



2



1

569 GENUA

EAN-Nr. EAN-No.

Farbe Colour

Leuchtmittel Lamp



Abmessungen Dimensions

Glas Glass

956906010000

4003474255330

Chrom Chrome

 6 x G9 / 33 W / 2800 K / 458 lm incl.  
 62  58  13

6508

2

569 GENUA

EAN-Nr. EAN-No.

Farbe Colour

Leuchtmittel Lamp

Abmessungen Dimensions

Glas Glass

956909010000

4003474255323

Chrom Chrome

 9 x G9 / 33 W / 2800 K / 458 lm incl.  
 Ø 75  13

6508

1

367 MONZA

EAN-Nr. EAN-No.
Farbe Colour

936701640000

4003474283739
Nickel-matt Nickel matt finished

Leuchtmittel Lamp
Abmessungen Dimensions
Glas Glass

 1 x LED / 24 W / 3000 K / 1800 lm incl. **A**
Ø 42,5 I 49
7249

2





169 SOLENA

EAN-Nr. EAN-No.
Farbe Colour

916901060000

4003474294483
Weiß White

Leuchtmittel Lamp
Abmessungen Dimensions
Zusatzinfos Extra-Information

 1 x LED / 60 W / 5500 lm incl. **A+**
Ø 58 I 7
  
Farbtemperaturwechsler von 3000K-6500K
Colour temperature changer 3000K-6500K
Nachlicht
Nightlight
stufenlos dimmbar
infinitely dimmable

1



LED

2



LED



1



LED

2



LED

Neu!
New!

3



LED

Neu!
New!

4



LED

Neu!
New!

1

871 VENETA

EAN-Nr. EAN-No.
Farbe Colour

987104010000

4003474284316
Chrom Chrome

Leuchtmittel Lamp
Abmessungen Dimensions

4 x LED / 3 W / 3000K / 210lm incl. **A+**
I 25 → 25 I 4

2

871 VENETA

EAN-Nr. EAN-No.
Farbe Colour

487101010000

4003474305646
Chrom Chrome

Leuchtmittel Lamp
Abmessungen Dimensions

1 x LED / 4,5 W / 3000K / 360lm incl. **A+**
I 9 → 9 I 4

3

871 VENETA

EAN-Nr. EAN-No.
Farbe Colour

987104640000

4003474296685
Nickel-matt Nickel matt finished

Leuchtmittel Lamp
Abmessungen Dimensions

4 x LED / 3 W / 3000K / 210lm incl. **A+**
I 25 → 25 I 4

4

871 VENETA

EAN-Nr. EAN-No.
Farbe Colour

987109640000

4003474296692
Nickel-matt Nickel matt finished

Leuchtmittel Lamp
Abmessungen Dimensions

9 x LED / 3 W / 3000K / 210lm incl. **A+**
I 35 → 35 I 4

1

223 MOODY **422301010000**
 EAN-Nr. EAN-No. 4003474300849
 Farbe Colour Chrom Chrome
 Leuchtmittel Lamp 1 x LED / 5 W / 3000 K / 400 lm incl. **A+**
 Abmessungen Dimensions ↔ 13 ↗ 13 ⚓ 7
 Glas Glass 7006, 7011

2

223 MOODY **922304010000**
 EAN-Nr. EAN-No. 4003474300870
 Farbe Colour Chrom Chrome
 Leuchtmittel Lamp 4 x LED / 5 W / 3000 K / 400 lm incl. **A+**
 Abmessungen Dimensions 130 ↔ 30 ⚓ 7
 Glas Glass 7006, 7024

3

223 MOODY **922305010000**
 EAN-Nr. EAN-No. 4003474300887
 Farbe Colour Chrom Chrome
 Leuchtmittel Lamp 5 x LED / 5 W / 3000 K / 400 lm incl. **A+**
 Abmessungen Dimensions 135 ↔ 35 ⚓ 7
 Glas Glass 7006, 7027



LED

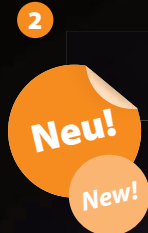

LED

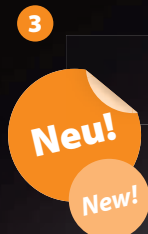

LED

1



LED

2



LED

1

754 LORENZ

EAN-Nr. EAN-No.

Farbe Colour

Leuchtmittel Lamp



Abmessungen Dimensions

Glas Glass

475401640000

4003474281438

Nickel-matt Nickel matt finished

 1 x LED / 10 W / 3000 K / 700 lm incl. **A**
 30  8  9,5

1391

2

754 LORENZ

EAN-Nr. EAN-No.

Farbe Colour

Leuchtmittel Lamp



Abmessungen Dimensions

Glas Glass

975401640000

4003474281445

Nickel-matt Nickel matt finished

 1 x LED / 15 W / 3000 K / 1100 lm incl. **A**
 40  8  9,5

1392

1

754 LORENZ

EAN-Nr. EAN-No.
Farbe Colour

Leuchtmittel Lamp
Abmessungen Dimensions
Glas Glass

975401640300

4003474281452
Nickel-matt Nickel matt finished

 1 x LED / 15 W / 3000 K / 1100 lm incl. **A**
Ø 30 \bar{I} 12
1393

2

754 LORENZ

EAN-Nr. EAN-No.
Farbe Colour

Leuchtmittel Lamp
Abmessungen Dimensions
Glas Glass

975401641300

4003474281476
Nickel-matt Nickel matt finished

 1 x LED / 15 W / 3000 K / 1100 lm incl. **A**
 \bar{I} 30 \leftrightarrow 30 \bar{I} 9,5
1395

1



LED

2



LED

1



LED

2



LED

3



LED

1

670 OSLO

EAN-Nr. EAN-No.
Farbe Colour

Leuchtmittel Lamp
Abmessungen Dimensions
Glas Glass

967001630330

4003474279664
Aluminium gebürstet Aluminium brass finished

1 x LED / 15 W / 3000 K / 1100 lm incl. **A**
Ø 35 I 9
1389

2

672 HALDEN

EAN-Nr. EAN-No.
Farbe Colour

Leuchtmittel Lamp
Abmessungen Dimensions
Glas Glass

967201630300

4003474279688
Aluminium gebürstet Aluminium brass finished

1 x LED / 15 W / 3000 K / 1100 lm incl. **A**
I 30 → 30 I 9
1390

3

376 MILA

EAN-Nr. EAN-No.
Farbe Colour

Leuchtmittel Lamp
Abmessungen Dimensions

937601640300

4003474273723
Nickel-matt Nickel matt finished

1 x LED / 10 W / 3000 K / 850 lm incl. **A***
I 30 → 30 I 10

1

876 MARA

EAN-Nr. EAN-No.
Farbe Colour

987601630260

4003474264516
Aluminium gebürstet Aluminium brass finished

Leuchtmittel Lamp
Abmessungen Dimensions

 1 x LED / 12,5W / 3000K / 730lm incl. **A**
Ø 26  9

2

876 MARA

EAN-Nr. EAN-No.
Farbe Colour

987601630330

4003474264523
Aluminium gebürstet Aluminium brass finished

Leuchtmittel Lamp
Abmessungen Dimensions

 1 x LED / 18,5W / 3000K / 1130lm incl. **A**
Ø 33  8,5

3



876 MARA

EAN-Nr. EAN-No.
Farbe Colour

987601630400

4003474263939
Aluminium gebürstet Aluminium brass finished

Leuchtmittel Lamp
Abmessungen Dimensions

 1 x LED / 25W / 3000K / 1570lm incl. **A**
Ø 40  10,5

1

LED



2

LED



3

LED



1



LED

1

881 SANA

EAN-Nr. EAN-No.
Farbe Colour

988101700250

4003474278537
Silber Silver

Leuchtmittel Lamp
Abmessungen Dimensions
Glas Glass

1 x LED / 10 W / 3000 K / 700 lm incl. **A**
Ø 28 7,7
1407

2



LED

2

881 SANA

EAN-Nr. EAN-No.
Farbe Colour

988101700330

4003474278544
Silber Silver

Leuchtmittel Lamp
Abmessungen Dimensions
Glas Glass

1 x LED / 15 W / 3000 K / 1100 lm incl. **A**
Ø 33 7,7
1397

3

881 SANA

EAN-Nr. EAN-No.
Farbe Colour

988101701350

4003474287843
Silber Silver

Leuchtmittel Lamp
Abmessungen Dimensions
Glas Glass

1 x LED / 15 W / 3000 K / 1100 lm incl. **A**
135 35 5,5
1521

3



LED

1



221 NOA

EAN-Nr. EAN-No.
Farbe Colour

922101060250

4003474281254
Weiß White

Leuchtmittel Lamp
Abmessungen Dimensions
Glas Glass

 1 x LED / 8W / 3000K / 760lm incl. **A+**
Ø 25  10
7290



LED

2



132 RENNES

EAN-Nr. EAN-No.
Farbe Colour

913201060300

4003474281162
Weiß White

Leuchtmittel Lamp
Abmessungen Dimensions
Glas Glass

 1 x LED / 12W / 3000K / 1000lm incl. **A**
Ø 30  10
6285



LED

3



132 RENNES

EAN-Nr. EAN-No.
Farbe Colour

913201060400

4003474281179
Weiß White

Leuchtmittel Lamp
Abmessungen Dimensions
Glas Glass

 1 x LED / 18W / 3000K / 1650lm incl. **A+**
Ø 40  10
6286



LED

1

Neu!
New!

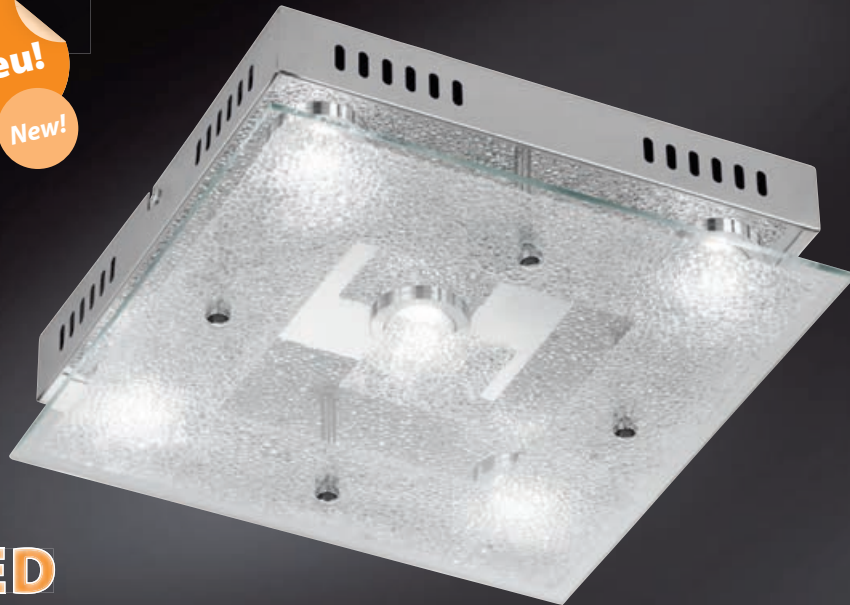

LED

1

562 BROOKS

EAN-Nr. EAN-No.
Farbe Colour

956205010000

4003474300306
Chrom Chrome

Leuchtmittel Lamp
Abmessungen Dimensions
Glas Glass

5 x LED / 5W / 3000K / 420lm incl. **A+**
130 30 7,5
1160

2

562 BROOKS

EAN-Nr. EAN-No.
Farbe Colour

956209010000

4003474300313
Chrom Chrome

Leuchtmittel Lamp
Abmessungen Dimensions
Glas Glass

9 x LED / 5W / 3000K / 420lm incl. **A+**
139 39 8
1161

2

Neu!
New!





LED

1

499 COLINA
 EAN-Nr. EAN-No. **949905010000**
 4003474265551
 Farbe Colour Chrom Chrome

Leuchtmittel Lamp  4 x G4 / 12 V / 20 W / 2800 K / 320 lm incl. **C**

Abmessungen Dimensions  Deco LED blau blue incl.
 Glas Glass I30 ↔ 30 ⚡ 14,5

Zusatzinfos Extra-Information  getrennt schaltbar
 separately switchable

2

767 MERLE
 EAN-Nr. EAN-No. **976701060300**
 4003474279695
 Farbe Colour Weiß White

Leuchtmittel Lamp  1 x LED / 15 W / 3000 K / 1200 lm incl. **A**

Abmessungen Dimensions I25 ↔ 25 ⚡ 5
 Glas Glass 3036



1

LED



2

LED



3

LED



4

LED



1

406 ZOE

EAN-Nr. EAN-No.
Farbe Colour

940605010000

4003474281605
Chrom Chrome

Leuchtmittel Lamp

4 x GU10 / 3 W / 3000K / 270lm incl. **A++**
 RGB LED incl.

Abmessungen Dimensions

∩ 40 ↔ 40 ⊥ 7,5

Glas Glass

6573

Zusatzinfos Extra-Information

getrennt schaltbar separately switchable

2

406 ZOE

EAN-Nr. EAN-No.
Farbe Colour

940605011000

4003474284040
Chrom Chrome

Leuchtmittel Lamp

4 x GU10 / 3 W / 3000K / 270lm incl. **A++**
 Deco LED weiß white incl.

Abmessungen Dimensions

∩ 40 ↔ 40 ⊥ 7,5

Glas Glass

6573

Zusatzinfos Extra-Information

getrennt schaltbar separately switchable

3

406 ZOE

EAN-Nr. EAN-No.
Farbe Colour

940610010000

4003474281612
Chrom Chrome

Leuchtmittel Lamp

9 x GU10 / 3 W / 3000K / 270lm incl. **A++**
 RGB LED incl.

Abmessungen Dimensions

∩ 53,5 ↔ 53,5 ⊥ 7,5

Glas Glass

6574

Zusatzinfos Extra-Information

getrennt schaltbar separately switchable

4

406 ZOE

EAN-Nr. EAN-No.
Farbe Colour

940610011000

4003474284057
Chrom Chrome

Leuchtmittel Lamp

9 x GU10 / 3 W / 3000K / 270lm incl. **A++**
 Deco LED weiß white incl.

Abmessungen Dimensions

∩ 53,5 ↔ 53,5 ⊥ 7,5

Glas Glass

6574

Zusatzinfos Extra-Information

getrennt schaltbar separately switchable

1

861 CALI

EAN-Nr. EAN-No.
Farbe Colour

Leuchtmittel Lamp

Abmessungen Dimensions
Glas Glass

Zusatzinfos Extra-Information

986105010000

4003474277783
Chrom Chrome

4 x GU10 / 5 W / 3000K / 300lm incl.
1 x RGB LED / 3 W / 70lm incl.

Ī 35 ↔ 35 Ī 11
6567



getrennt schaltbar separately switchable



2

861 CALI

EAN-Nr. EAN-No.
Farbe Colour

Leuchtmittel Lamp

Abmessungen Dimensions
Glas Glass

Zusatzinfos Extra-Information

986105011000

4003474278353
Chrom Chrome

4 x GU10 / 5 W / 3000K / 300lm incl.
1 x weiße white LED / 3 W / 70lm incl.

Ī 35 ↔ 35 Ī 11
6567



getrennt schaltbar separately switchable

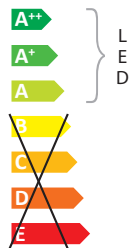

1

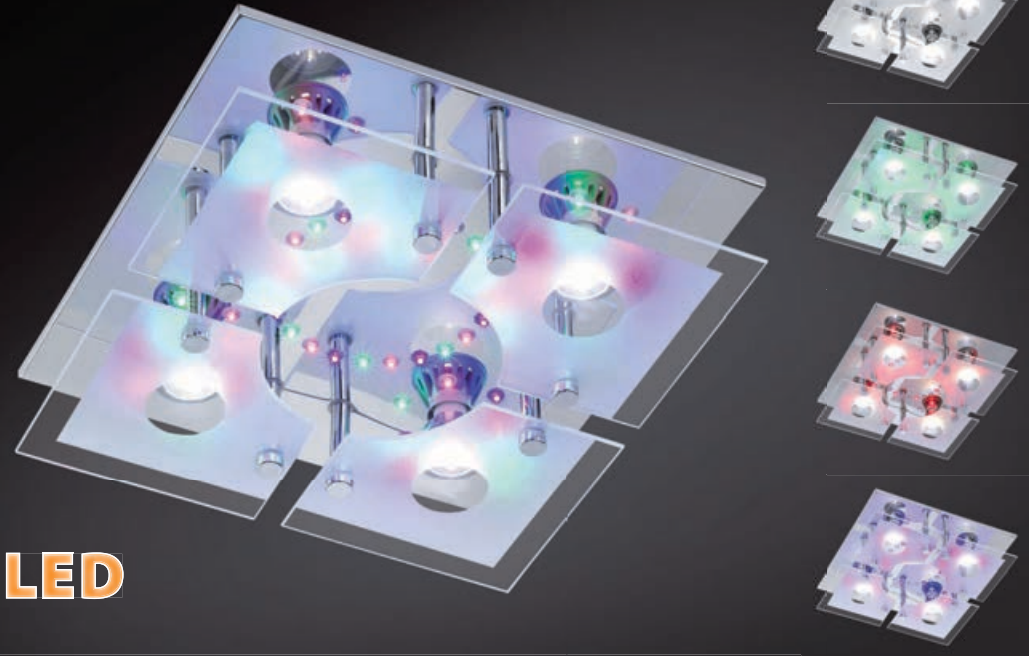

LED

2



LED

1

LED

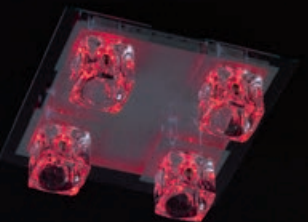

2

LED

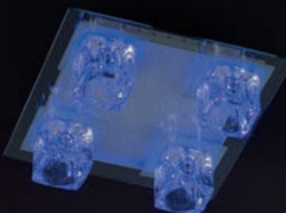
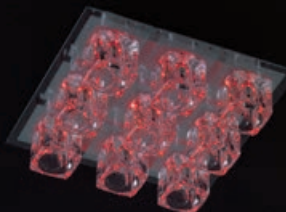

1

929 VISIONEAN-Nr. EAN-No.
Farbe Colour

Leuchtmittel Lamp

Abmessungen Dimensions

Glas Glass

Zusatzinfos Extra-Information

9929050600004003474245560
Weiß White4 x G4 / 12V / 20W / 2800K / 255lm incl. **C**

RGB LED incl.

I30 ← 30 ↓ 10

7909, 6511

getrennt schaltbar
separately switchable

2

929 VISIONEAN-Nr. EAN-No.
Farbe Colour

Leuchtmittel Lamp

Abmessungen Dimensions

Glas Glass

Zusatzinfos Extra-Information

9929100600004003474245553
Weiß White9 x G4 / 12V / 20W / 2800K / 255lm incl. **C**

RGB LED incl.

I36 ← 36 ↓ 10

7909, 6512

getrennt schaltbar
separately switchable

1

367 MONZA

436701640000

EAN-Nr. EAN-No.

4003474281186

Farbe Colour

Nickel-matt Nickel matt finished

Leuchtmittel Lamp

 1 x LED / 5 W / 3000K / 360lm incl. **A+**

Abmessungen Dimensions

↳ 15 ↗ 8 ⊥ 18,5

Glas Glass

7248

2

367 MONZA

736702640000

EAN-Nr. EAN-No.

4003474281193

Farbe Colour

Nickel-matt Nickel matt finished

Leuchtmittel Lamp

 2 x LED / 5 W / 3000K / 360lm incl. **A+**

Abmessungen Dimensions

↳ 34 ↗ 8 ⊥ 18,5

Glas Glass

7248

3

367 MONZA

736704640000

EAN-Nr. EAN-No.

4003474283760

Farbe Colour

Nickel-matt Nickel matt finished

Leuchtmittel Lamp

 4 x LED / 5 W / 3000K / 360lm incl. **A+**

Abmessungen Dimensions

↳ 80 ↗ 8 ⊥ 18,5

Glas Glass

7248

4

367 MONZA

936706640000

EAN-Nr. EAN-No.

4003474281223

Farbe Colour

Nickel-matt Nickel matt finished

Leuchtmittel Lamp

 6 x LED / 5 W / 3000K / 360lm incl. **A+**

Abmessungen Dimensions

↳ 150 ↗ 9 ⊥ 18,5

Glas Glass

7248

Zusatzinfos Extra-Information





LED



LED



LED



LED

1



LED

2



LED

Neu!

New!

Neu!
New!

3



LED

Neu!

New!

4



LED

Neu!

New!

5



LED

Neu!

New!

1

336 MORGAN

EAN-Nr. EAN-No.
Farbe Colour

433601010000

4003474300894
Chrom Chrome

Leuchtmittel Lamp
Abmessungen Dimensions
Glas Glass

1 x LED / 5W / 3000K / 400lm incl. **A+**
Ø 8 12,5
7006

2

336 MORGAN

EAN-Nr. EAN-No.
Farbe Colour

733602010000

4003474300900
Chrom Chrome

Leuchtmittel Lamp
Abmessungen Dimensions
Glas Glass

2 x LED / 5W / 3000K / 400lm incl. **A+**
26,5 8 15
7006

3

336 MORGAN

EAN-Nr. EAN-No.
Farbe Colour

733604010000

4003474300931
Chrom Chrome

Leuchtmittel Lamp
Abmessungen Dimensions
Glas Glass
Zusatzinfos Extra-Information

4 x LED / 5W / 3000K / 400lm incl. **A+**
71,5 8 15,5
7006

4

336 MORGAN

EAN-Nr. EAN-No.
Farbe Colour

933603010000

4003474300948
Chrom Chrome

Leuchtmittel Lamp
Abmessungen Dimensions
Glas Glass

3 x LED / 5W / 3000K / 400lm incl. **A+**
Ø 30 15
7006

5

336 MORGAN

EAN-Nr. EAN-No.
Farbe Colour

933606010000

4003474300955
Chrom Chrome

Leuchtmittel Lamp
Abmessungen Dimensions
Glas Glass
Zusatzinfos Extra-Information

6 x LED / 5W / 3000K / 400lm incl. **A+**
161 9 17
7006

1

516 LUGO

EAN-Nr. EAN-No.
Farbe Colour

451601010000

4003474295602
Chrom Chrome

Leuchtmittel Lamp
Abmessungen Dimensions
Glas Glass
Zusatzinfos Extra-Information

1 x LED / 5W / 3000K / 400lm incl. **A+**
I 13,5 ↗ 8 ↘ 15
1458

2

516 LUGO

EAN-Nr. EAN-No.
Farbe Colour

751602010000

4003474295619
Chrom Chrome

Leuchtmittel Lamp
Abmessungen Dimensions
Glas Glass

2 x LED / 5W / 3000K / 400lm incl. **A+**
↔ 36 ↗ 8 ↘ 18
1458

3

516 LUGO

EAN-Nr. EAN-No.
Farbe Colour

751604010000

4003474295626
Chrom Chrome

Leuchtmittel Lamp
Abmessungen Dimensions
Glas Glass
Zusatzinfos Extra-Information

4 x LED / 5W / 3000K / 400lm incl. **A+**
↔ 90 ↗ 9 ↘ 18
1458

4

516 LUGO

EAN-Nr. EAN-No.
Farbe Colour

951606010000

4003474295640
Chrom Chrome

Leuchtmittel Lamp
Abmessungen Dimensions
Glas Glass
Zusatzinfos Extra-Information

6 x LED / 5W / 3000K / 400lm incl. **A+**
↔ 194 ↗ 11 ↘ 20
1458



LED

Neu!
New!



LED

Neu!
New!



LED

Neu!
New!



LED

Neu!
New!

1



LED

2



LED

3



LED

4



LED

5

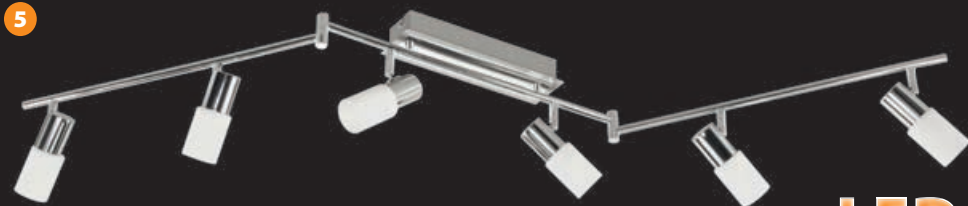

LED

1

677 BAS

EAN-Nr. EAN-No.
Farbe Colour

467701540000

4003474289366
Nickel-matt/Chrom
Nickel matt finished/Chrome

Leuchtmittel Lamp
Abmessungen Dimensions
Glas Glass
Zusatzinfos Extra-Information

1 x LED / 5 W / 3000 K / 400lm incl. **A+**
I 14 ↗ 7 H 16
6588
🔌

2

677 BAS

EAN-Nr. EAN-No.
Farbe Colour

967703540000

4003474289243
Nickel-matt/Chrom
Nickel matt finished/Chrome

Leuchtmittel Lamp
Abmessungen Dimensions
Glas Glass

3 x LED / 5 W / 3000 K / 400lm incl. **A+**
Ø 28 H 20
6588

3

677 BAS

EAN-Nr. EAN-No.
Farbe Colour

767702540000

4003474289182
Nickel-matt/Chrom
Nickel matt finished/Chrome

Leuchtmittel Lamp
Abmessungen Dimensions
Glas Glass

2 x LED / 5 W / 3000 K / 400lm incl. **A+**
↔ 33 ↗ 7,5 H 20
6588

4

677 BAS

EAN-Nr. EAN-No.
Farbe Colour

767704540000

4003474289199
Nickel-matt/Chrom
Nickel matt finished/Chrome

Leuchtmittel Lamp
Abmessungen Dimensions
Glas Glass
Zusatzinfos Extra-Information

4 x LED / 5 W / 3000 K / 400lm incl. **A+**
↔ 94 ↗ 7,5 H 20
6588
🔌

5

677 BAS

EAN-Nr. EAN-No.
Farbe Colour

967706540000

4003474289250
Nickel-matt/Chrom
Nickel matt finished/Chrome

Leuchtmittel Lamp
Abmessungen Dimensions
Glas Glass
Zusatzinfos Extra-Information

6 x LED / 5 W / 3000 K / 400lm incl. **A+**
↔ 150 ↗ 7,5 H 21,5
6588
🔌

1

388 ALVIS **438801640000**
 EAN-Nr. EAN-No. 4003474273198
 Farbe Colour Nickel-matt Nickel matt finished
 Leuchtmittel Lamp 1 x E14 / 3 W / 3000 K / 260 lm incl. **A+**
 Abmessungen Dimensions 113 7 13
 Glas Glass 6256
 Zusatzinfos Extra-Information

2

388 ALVIS **938803640000**
 EAN-Nr. EAN-No. 4003474273211
 Farbe Colour Nickel-matt Nickel matt finished
 Leuchtmittel Lamp 3 x E14 / 3 W / 3000 K / 260 lm incl. **A+**
 Abmessungen Dimensions Ø 35,5 15,5
 Glas Glass 6256

3

388 ALVIS **738802640000**
 EAN-Nr. EAN-No. 4003474273204
 Farbe Colour Nickel-matt Nickel matt finished
 Leuchtmittel Lamp 2 x E14 / 3 W / 3000 K / 260 lm incl. **A+**
 Abmessungen Dimensions 31,5 7 13
 Glas Glass 6256

4

388 ALVIS **938804640000**
 EAN-Nr. EAN-No. 4003474273228
 Farbe Colour Nickel-matt Nickel matt finished
 Leuchtmittel Lamp 4 x E14 / 3 W / 3000 K / 260 lm incl. **A+**
 Abmessungen Dimensions 84 16
 Glas Glass 6256
 Zusatzinfos Extra-Information

5

388 ALVIS **938806640000**
 EAN-Nr. EAN-No. 4003474273235
 Farbe Colour Nickel-matt Nickel matt finished
 Leuchtmittel Lamp 6 x E14 / 3 W / 3000 K / 260 lm incl. **A+**
 Abmessungen Dimensions 198 17,5
 Glas Glass 6256
 Zusatzinfos Extra-Information



LED

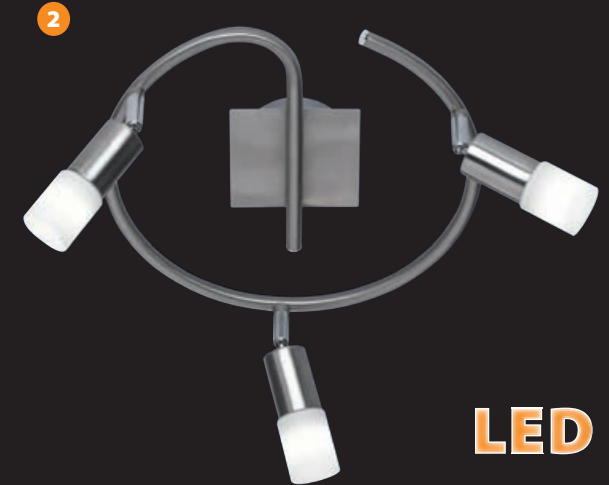

LED



LED



LED



LED

1



Neu!

New!

LED

2



Neu!

New!

LED

3



Neu!

New!

LED

4



Neu!

New!

LED

5



Neu!

New!

LED

1

853 OAK

EAN-Nr. EAN-No.
Farbe Colour

485301640000

4003474304663
Nickel-matt Nickel matt finished

Leuchtmittel Lamp
Abmessungen Dimensions

1 x LED / 5W / 3000K / 400lm incl. **A+**
Ø 8 ↗ 8 ⇄ 14

2

853 OAK

EAN-Nr. EAN-No.
Farbe Colour

785302640000

4003474304670
Nickel-matt Nickel matt finished

Leuchtmittel Lamp
Abmessungen Dimensions

2 x LED / 5W / 3000K / 400lm incl. **A+**
⇄ 43 ↗ 8 ⊥ 16

3

853 OAK

EAN-Nr. EAN-No.
Farbe Colour

785304640000

4003474304687
Nickel-matt Nickel matt finished

Leuchtmittel Lamp
Abmessungen Dimensions
Zusatzinfos Extra-Information

4 x LED / 5W / 3000K / 400lm incl. **A+**
⇄ 79 ↗ 9 ⊥ 16

4

853 OAK

EAN-Nr. EAN-No.
Farbe Colour

985303640000

4003474304694
Nickel-matt Nickel matt finished

Leuchtmittel Lamp
Abmessungen Dimensions

3 x LED / 5W / 3000K / 400lm incl. **A+**
Ø 30 ⊥ 17

5

853 OAK







EAN-Nr. EAN-No.
Farbe Colour

985306640000

4003474299839
Nickel-matt Nickel matt finished

Leuchtmittel Lamp
Abmessungen Dimensions
Zusatzinfos Extra-Information

6 x LED / 5W / 3000K / 400lm incl. **A+**
⇄ 180 ↗ 9 ⊥ 16

- 1**
- 251 LESTER** **425101540000**
 EAN-Nr. EAN-No. 4003474300122
 Farbe Colour Nickel matt/Chrom Nickel matt finished/Chrome
- Leuchtmittel Lamp  1 x LED / 5 W / 3000 K / 380 lm incl. **A+**
 Abmessungen Dimensions \varnothing 8 \rightarrow 13,5
- 2**
- 251 LESTER** **725102540000**
 EAN-Nr. EAN-No. 4003474300139
 Farbe Colour Nickel matt/Chrom Nickel matt finished/Chrome
- Leuchtmittel Lamp  2 x LED / 5 W / 3000 K / 380 lm incl. **A+**
 Abmessungen Dimensions \rightarrow 30 \rightarrow 8 \downarrow 15
- 3**
- 251 LESTER** **725104540000**
 EAN-Nr. EAN-No. 4003474300146
 Farbe Colour Nickel matt/Chrom Nickel matt finished/Chrome
- Leuchtmittel Lamp  4 x LED / 5 W / 3000 K / 380 lm incl. **A+**
 Abmessungen Dimensions \rightarrow 58 \rightarrow 8 \downarrow 15
- 4**
- 251 LESTER** **925103540000**
 EAN-Nr. EAN-No. 4003474300153
 Farbe Colour Nickel matt/Chrom Nickel matt finished/Chrome
- Leuchtmittel Lamp  3 x LED / 5 W / 3000 K / 380 lm incl. **A+**
 Abmessungen Dimensions \varnothing 26 \downarrow 15
- 5**
- 251 LESTER** **925106540000**
 EAN-Nr. EAN-No. 4003474300160
 Farbe Colour Nickel matt/Chrom Nickel matt finished/Chrome
- Leuchtmittel Lamp  6 x LED / 5 W / 3000 K / 380 lm incl. **A+**
 Abmessungen Dimensions \rightarrow 180 \downarrow 17
 Zusatzinfos Extra-Information 



1

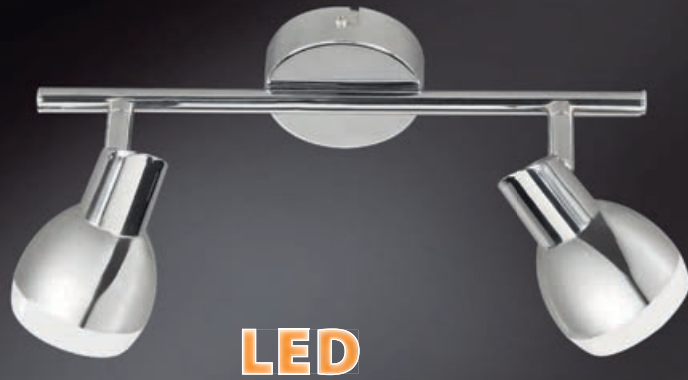

LED

1

269 NANTES

EAN-Nr. EAN-No.
Farbe Colour

726902010000

4003474281278
Chrom Chrome

Leuchtmittel Lamp
Abmessungen Dimensions
Glas Glass

2 x LED / 5W / 3000K / 380lm incl. **A+**
← 30 ↗ 8 ⊥ 16
6621

2



LED

2

269 NANTES

EAN-Nr. EAN-No.
Farbe Colour

726904010000

4003474281285
Chrom Chrome

Leuchtmittel Lamp
Abmessungen Dimensions
Glas Glass

4 x LED / 5W / 3000K / 380lm incl. **A+**
← 58 ↗ 8 ⊥ 16
6621

3



LED

3

269 NANTES

EAN-Nr. EAN-No.
Farbe Colour

926906010000

4003474289557
Chrom Chrome

Leuchtmittel Lamp
Abmessungen Dimensions
Glas Glass

6 x LED / 5W / 3000K / 380lm incl. **A+**
← 160 ⊥ 18
6621

4



LED

4

269 NANTES

EAN-Nr. EAN-No.
Farbe Colour

926906011000

4003474281292
Chrom Chrome

Leuchtmittel Lamp
Abmessungen Dimensions
Glas Glass

6 x LED / 5W / 3000K / 380lm incl. **A+**
← 86 ↗ 38 ⊥ 20
6621

5



269 NANTES

EAN-Nr. EAN-No.
Farbe Colour

426901010000

4003474281261
Chrom Chrome

Leuchtmittel Lamp
Abmessungen Dimensions
Glas Glass

 1 x LED / 5W / 3000K / 380lm incl. 
Ø 8 H 15
6621

6



269 NANTES

EAN-Nr. EAN-No.
Farbe Colour

926903010000

4003474291666
Chrom Chrome

Leuchtmittel Lamp
Abmessungen Dimensions
Glas Glass

 3 x LED / 5W / 3000K / 380lm incl. 
Ø 20 H 16
6621

5



LED

6



LED



LED



LED



LED



LED



LED

1

071 NOIS

EAN-Nr. EAN-No.
Farbe Colour

Leuchtmittel Lamp
Abmessungen Dimensions
Glas Glass
Zusatzinfos Extra-Information

407101640000

4003474283326
Nickel-matt Nickel matt finished

1 x LED / 5 W / 3000K / 380lm incl. **A+**
Ø 9 H 16
1410

2

071 NOIS

EAN-Nr. EAN-No.
Farbe Colour

Leuchtmittel Lamp
Abmessungen Dimensions
Glas Glass

907103640000

4003474284354
Nickel-matt Nickel matt finished

3 x LED / 5 W / 3000K / 380lm incl. **A+**
Ø 30 H 19
1410

3

071 NOIS

EAN-Nr. EAN-No.
Farbe Colour

Leuchtmittel Lamp
Abmessungen Dimensions
Glas Glass

707102640000

4003474283333
Nickel-matt Nickel matt finished

2 x LED / 5 W / 3000K / 380lm incl. **A+**
→ 46,5 H 19
1410

4

071 NOIS

EAN-Nr. EAN-No.
Farbe Colour

Leuchtmittel Lamp
Abmessungen Dimensions
Glas Glass

907104640000

4003474283357
Nickel-matt Nickel matt finished

4 x LED / 5 W / 3000K / 380lm incl. **A+**
→ 80 H 19,5
1410

5

071 NOIS

EAN-Nr. EAN-No.
Farbe Colour

Leuchtmittel Lamp
Abmessungen Dimensions
Glas Glass
Zusatzinfos Extra-Information

907106640000

4003474283364
Nickel-matt Nickel matt finished

6 x LED / 5 W / 3000K / 380lm incl. **A+**
→ 170 H 21,5
1410

1

634 SOLUTION **763404010000**
 EAN-Nr. EAN-No. 4003474251387
 Farbe Colour Chrom Chrome

Leuchtmittel Lamp 4 x GU10 / 3 W / 3000 K / 250 lm incl. **A+**
 Abmessungen Dimensions → 81 ↓ 17

2

634 SOLUTION **963406010000**
 EAN-Nr. EAN-No. 4003474265001
 Farbe Colour Chrom Chrome

Leuchtmittel Lamp 6 x GU10 / 3 W / 3000 K / 250 lm incl. **A+**
 Abmessungen Dimensions → 180 ↓ 17
 Zusatzinfos Extra-Information

3

634 SOLUTION **463401010000**
 EAN-Nr. EAN-No. 4003474251363
 Farbe Colour Chrom Chrome

Leuchtmittel Lamp 1 x GU10 / 3 W / 3000 K / 250 lm incl. **A+**
 Abmessungen Dimensions ↓ 13 → 7 ↓ 14
 Zusatzinfos Extra-Information

4

634 SOLUTION **763402010000**
 EAN-Nr. EAN-No. 4003474251370
 Farbe Colour Chrom Chrome

Leuchtmittel Lamp 2 x GU10 / 3 W / 3000 K / 250 lm incl. **A+**
 Abmessungen Dimensions → 33 ↓ 17



LED



LED



LED



LED



LED



LED



LED

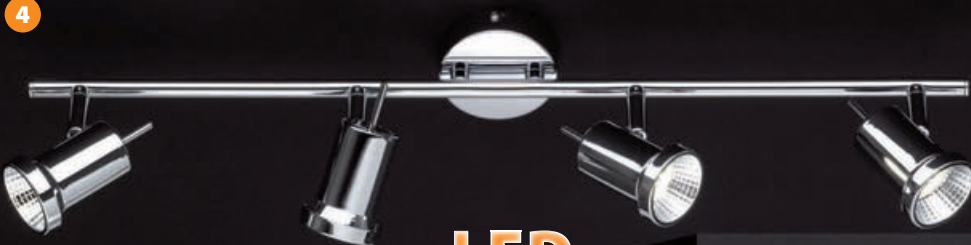

LED



LED

1

503 HOORN

EAN-Nr. EAN-No.
Farbe Colour

450301010000

4003474267852
Chrom Chrome

Leuchtmittel Lamp
Abmessungen Dimensions

1 x LED / 5 W / 3000 K / 400 lm incl. **A+**
Ø 8 I 12

2

503 HOORN

EAN-Nr. EAN-No.
Farbe Colour

750302010000

4003474267869
Chrom Chrome

Leuchtmittel Lamp
Abmessungen Dimensions

2 x LED / 5 W / 3000 K / 400 lm incl. **A+**
↔ 25 ↗ 8 I 14

3

503 HOORN

EAN-Nr. EAN-No.
Farbe Colour

750303010000

4003474267876
Chrom Chrome

Leuchtmittel Lamp
Abmessungen Dimensions

3 x LED / 5 W / 3000 K / 400 lm incl. **A+**
↔ 43 ↗ 8 I 14

4

503 HOORN

EAN-Nr. EAN-No.
Farbe Colour

750304010000

4003474274546
Chrom Chrome

Leuchtmittel Lamp
Abmessungen Dimensions

4 x LED / 5 W / 3000 K / 400 lm incl. **A+**
↔ 63 ↗ 8 I 14

5

503 HOORN

EAN-Nr. EAN-No.
Farbe Colour

950306010000

4003474278391
Chrom Chrome

Leuchtmittel Lamp
Abmessungen Dimensions
Zusatzinfos Extra-Information

6 x LED / 5 W / 3000 K / 400 lm incl. **A+**
↔ 150 ↗ 8 I 14

1

503 HOORN

450301640000

EAN-Nr. EAN-No.
Farbe Colour

4003474289090
Nickel-matt Nickel matt finished

Leuchtmittel Lamp
Abmessungen Dimensions

 1 x LED / 5W / 3000K / 400lm incl. **A+**
Ø 8 H 12

2

503 HOORN

750302640000

EAN-Nr. EAN-No.
Farbe Colour

4003474289106
Nickel-matt Nickel matt finished

Leuchtmittel Lamp
Abmessungen Dimensions

 2 x LED / 5W / 3000K / 400lm incl. **A+**
↔ 25 ↗ 8 ⊥ 14

3

503 HOORN

750303640000

EAN-Nr. EAN-No.
Farbe Colour

4003474289113
Nickel-matt Nickel matt finished

Leuchtmittel Lamp
Abmessungen Dimensions

 3 x LED / 5W / 3000K / 400lm incl. **A+**
↔ 43 ↗ 8 ⊥ 14

4

503 HOORN

750304640000

EAN-Nr. EAN-No.
Farbe Colour

4003474289120
Nickel-matt Nickel matt finished

Leuchtmittel Lamp
Abmessungen Dimensions

 4 x LED / 5W / 3000K / 400lm incl. **A+**
↔ 63 ↗ 8 ⊥ 14

5



503 HOORN

950306640000

EAN-Nr. EAN-No.
Farbe Colour

4003474289137
Nickel-matt Nickel matt finished

Leuchtmittel Lamp
Abmessungen Dimensions
Zusatzinfos Extra-Information

 6 x LED / 5W / 3000K / 400lm incl. **A+**
↔ 150 ↗ 8 ⊥ 14



LED



LED



LED



LED



LED

1

Neu!
New!



LED

1

716 FIELD

EAN-Nr. EAN-No.
Farbe Colour

Leuchtmittel Lamp
Abmessungen Dimensions
Zusatzinfos Extra-Information

371601970000

4003474296883
Edelstahl gebürstet stainless steel brushed

1 x LED / 5 W / 3000K / 340lm incl.
I 45 ↔ 15,5 ↗ 15,5
IP44

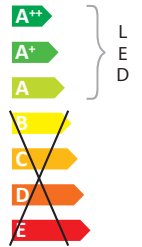

2

716 FIELD

EAN-Nr. EAN-No.
Farbe Colour

Leuchtmittel Lamp
Abmessungen Dimensions
Zusatzinfos Extra-Information

471601970000

4003474296890
Edelstahl gebürstet stainless steel brushed

1 x LED / 5 W / 3000K / 340lm incl.
I 15 ↔ 17,5
IP44

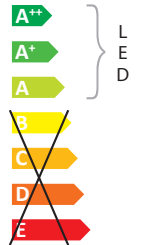

2

Neu!
New!



LED

Outdoor line

1

714 CENTRAL

371401970000

EAN-Nr. EAN-No.

4003474296876

Farbe Colour

Edelstahl gebürstet stainless steel brushed

Leuchtmittel Lamp

 1 x LED / 5W / 3000K / 340lm incl.

Abmessungen Dimensions

∅ 60 → 12

Zusatzinfos Extra-Information

IP44



2

714 CENTRAL

471401970000

EAN-Nr. EAN-No.

4003474296869

Farbe Colour

Edelstahl gebürstet stainless steel brushed

Leuchtmittel Lamp

 1 x LED / 5W / 3000K / 340lm incl.

Abmessungen Dimensions

∅ 24 ✓ 8 → 14

Zusatzinfos Extra-Information

IP44



3

714 CENTRAL

471401970500

EAN-Nr. EAN-No.

4003474296852

Farbe Colour

Edelstahl gebürstet stainless steel brushed

Leuchtmittel Lamp

 1 x LED / 5W / 3000K / 340lm incl.

Abmessungen Dimensions

∅ 35 ✓ 8 → 15

Zusatzinfos Extra-Information

IP44



Outdoor line

1



LED

2



LED

3



LED

1

Neu!

New!



1

766 QUEENS

476601880000

EAN-Nr. EAN-No.
Farbe Colour

4003474298313
Anthrazit dark grey

Abmessungen Dimensions
Glas Glass
Zusatzinfos Extra-Information

∩ 30,5 √ 30 ∣→ 34,5
1431
IP 44 Fit for LED



geeignet für
suitable for
1 x E27 /
max. 60W



2

766 QUEENS

476601880500

EAN-Nr. EAN-No.
Farbe Colour

4003474298320
Anthrazit dark grey

Abmessungen Dimensions
Glas Glass
Zusatzinfos Extra-Information

∩ 24,5 √ 30 ∣→ 37,5
1431
IP 44 Fit for LED



geeignet für
suitable for
1 x E27 /
max. 60W



Outdoor line

2

Neu!

New!



1

724 FERRY **372401970800**

EAN-Nr. EAN-No. 4003474296913

Farbe Colour Edelstahl gebürstet
stainless steel brushed

Abmessungen Dimensions \bar{I} 80 \leftrightarrow 22 \swarrow 22

Glas Glass 3057

Zusatzinfos Extra-Information IP 44 Fit for LED

A++
A+
A
B
C
D
E

geeignet für
suitable for
1 x E27 /
max. 46 W



2

724 FERRY **472401970510**

EAN-Nr. EAN-No. 4003474296944

Farbe Colour Edelstahl gebürstet
stainless steel brushed

Abmessungen Dimensions \bar{I} 32,5 \leftrightarrow 22 \rightarrow 28

Glas Glass 3057

Zusatzinfos Extra-Information IP 44
Bewegungsmelder /
Motion sensor

A++
A+
A
B
C
D
E

geeignet für
suitable for
1 x E27 /
max. 46 W



3

724 FERRY **472401970000**

EAN-Nr. EAN-No. 4003474296920

Farbe Colour Edelstahl gebürstet
stainless steel brushed



Abmessungen Dimensions \bar{I} 32,5 \leftrightarrow 22 \rightarrow 26

Glas Glass 3057

Zusatzinfos Extra-Information IP 44 Fit for LED

A++
A+
A
B
C
D
E

geeignet für
suitable for
1 x E27 /
max. 46 W

Outdoor line

1
Neu!

New!



2
Neu!

New!



3
Neu!

New!



1



Neu!

New!



2



Neu!

New!



3



Neu!

New!



4



Neu!

New!



1

794 MANHATTAN

379401500500

EAN-Nr. EAN-No.
Farbe Colour

4003474298412
Grau grey

Abmessungen Dimensions
Glas Glass
Zusatzinfos Extra-Information

Ī 58 ↗ 26 ĩ 40
1430
IP 44 Fit for LED



geeignet für
suitable for
1 x E27 /
max. 60 W



2

794 MANHATTAN

379401501000

EAN-Nr. EAN-No.
Farbe Colour

4003474298429
Grau grey

Abmessungen Dimensions
Glas Glass
Zusatzinfos Extra-Information

Ī 95 ↗ 26 ĩ 40
1430
IP 44 Fit for LED



geeignet für
suitable for
1 x E27 /
max. 60 W



3

794 MANHATTAN

379401880500

EAN-Nr. EAN-No.
Farbe Colour

4003474298436
Anthrazit dark grey

Abmessungen Dimensions
Glas Glass
Zusatzinfos Extra-Information

Ī 58 ↗ 26 ĩ 40
1430
IP 44 Fit for LED



geeignet für
suitable for
1 x E27 /
max. 60 W



4

794 MANHATTAN

379401881000

EAN-Nr. EAN-No.
Farbe Colour

4003474298443
Anthrazit dark grey

Abmessungen Dimensions
Glas Glass
Zusatzinfos Extra-Information

Ī 95 ↗ 26 ĩ 40
1430
IP 44 Fit for LED



geeignet für
suitable for
1 x E27 /
max. 60 W



Outdoor line

5

794 MANHATTAN **479401500500**

EAN-Nr. EAN-No. 4003474298375
 Farbe Colour Grau grey

Abmessungen Dimensions I 26 ↗ 26 H 33
 Glas Glass 1430
 Zusatzinfos Extra-Information IP 44 Fit for LED

A++
 A+
 A
 B
 C
 D
 E

geeignet für suitable for
 1 x E27 / max. 60 W



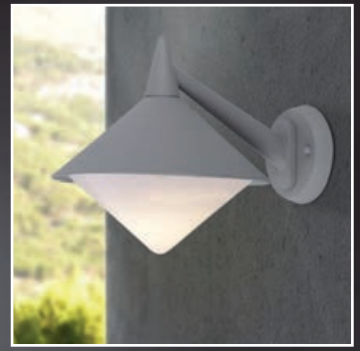

6

794 MANHATTAN **479401880500**

EAN-Nr. EAN-No. 4003474298382
 Farbe Colour Anthrazit dark grey

Abmessungen Dimensions I 26 ↗ 26 H 33
 Glas Glass 1430
 Zusatzinfos Extra-Information IP 44 Fit for LED

A++
 A+
 A
 B
 C
 D
 E

geeignet für suitable for
 1 x E27 / max. 60 W





7



794 MANHATTAN **679401060000**

EAN-Nr. EAN-No. 4003474298399
 Farbe Colour Weiß White

Abmessungen Dimensions I 85 ↔ 26 Ø 26
 Glas Glass 1430
 Zusatzinfos Extra-Information IP 44 Fit for LED

A++
 A+
 A
 B
 C
 D
 E

geeignet für suitable for
 1 x E27 / max. 60 W

Outdoor line

1



LED



1

LED GU10

EAN-Nr. EAN-No.

9705

4003474274799

Nennleistung Power	3 W
Nennspannung Nominal voltage	220-240 V
Farbtemperatur Colour temperature	3000 K
Lichtleistung Luminous flux	250 lm
Farbwiedergabeindex Rendering index Ra	>80
Lebensdauer Life span	20 000 h
Schaltzyklen Switching cycles	15 000
Ausstrahlwinkel Beam angle	110°
Sockel Socket	GU10
Abmessung Dimensions	Ø 5 cm 5,7 cm
dimmbar dimmable	nein no

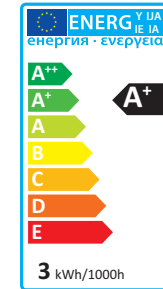

Die Lampe ist für eine Akzentbeleuchtung nicht geeignet
The lamp is not suitable for accent lighting

2



LED



2

LED E14

EAN-Nr. EAN-No.

9706

4003474277554

Nennleistung Power	3 W
Nennspannung Nominal voltage	230 V
Farbtemperatur Colour temperature	3000 K
Lichtleistung Luminous flux	260 lm
Farbwiedergabeindex Rendering index Ra	>80
Lebensdauer Life span	20 000 h
Schaltzyklen Switching cycles	15 000
Ausstrahlwinkel Beam angle	
Sockel Socket	E14
Abmessung Dimensions	Ø 3 cm 5,8 cm
dimmbar dimmable	nein no

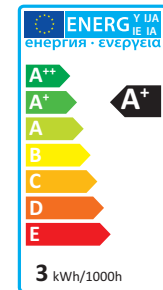

3



LED



3

LED E14

EAN-Nr. EAN-No.

9710

4003474279282

Nennleistung Power	4 W
Nennspannung Nominal voltage	220-240 V
Farbtemperatur Colour temperature	3000 K
Lichtleistung Luminous flux	430 lm
Farbwiedergabeindex Rendering index Ra	>80
Lebensdauer Life span	20 000 h
Schaltzyklen Switching cycles	15 000
Ausstrahlwinkel Beam angle	
Sockel Socket	E14
Abmessung Dimensions	Ø 3 cm 8,8 cm
dimmbar dimmable	nein no

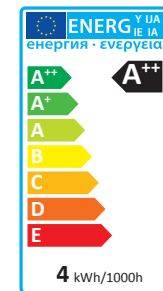

1

LED E27

EAN-Nr. EAN-No.

Nennleistung Power
 Nennspannung Nominal voltage
 Farbtemperatur Colour temperature
 Lichtleistung Luminous flux
 Farbwiedergabeindex Rendering index Ra
 Lebensdauer Life span
 Schaltzyklen Switching cycles
 Ausstrahlwinkel Beam angle
 Sockel Socket
 Abmessung Dimensions
 dimmbar dimmable

9712

4003474285733

10 W
 220-240 V
 3000 K
 806 lm
 >80
 25 000 h
 12 500
 270°
 E27
 Ø 6 cm I 11,8 cm
 ja yes

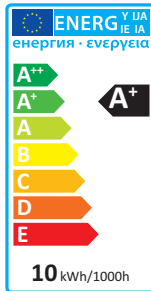

dimmbar
dimmable



LED



2

LED E27

EAN-Nr. EAN-No.

Nennleistung Power
 Nennspannung Nominal voltage
 Farbtemperatur Colour temperature
 Lichtleistung Luminous flux
 Farbwiedergabeindex Rendering index Ra
 Lebensdauer Life span
 Schaltzyklen Switching cycles
 Ausstrahlwinkel Beam angle
 Sockel Socket
 Abmessung Dimensions
 dimmbar dimmable

9713

4003474285740

7 W
 220-240 V
 3000 K
 470 lm
 >80
 25 000 h
 12 500
 270°
 E27
 Ø 6 cm I 11,8 cm
 nein no

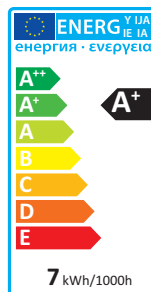

2



LED



3

LED E14

EAN-Nr. EAN-No.

Nennleistung Power
 Nennspannung Nominal voltage
 Farbtemperatur Colour temperature
 Lichtleistung Luminous flux
 Farbwiedergabeindex Rendering index Ra
 Lebensdauer Life span
 Schaltzyklen Switching cycles
 Ausstrahlwinkel Beam angle
 Sockel Socket
 Abmessung Dimensions
 dimmbar dimmable

9714

4003474285757

4 W
 220-240 V
 3000 K
 320 lm
 >80
 25 000 h
 12 500
 160°
 E14
 Ø 4,5 cm I 7,9 cm
 nein no

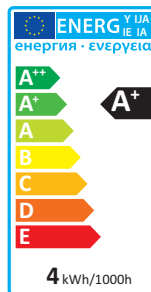

3



LED



1



LED



1

LED E14

EAN-Nr. EAN-No.

Nennleistung Power
 Nennspannung Nominal voltage
 Farbtemperatur Colour temperature
 Lichtleistung Luminous flux
 Farbwiedergabeindex Rendering index Ra
 Lebensdauer Life span
 Schaltzyklen Switching cycles
 Ausstrahlwinkel Beam angle
 Sockel Socket
 Abmessung Dimensions
 dimmbar dimmable

9715

4003474285764

4 W
 220-240 V
 3000 K
 320 lm
 >80
 25 000 h
 12 500
 160°
 E14
 Ø 3,7 cm I 9,9 cm
 nein no

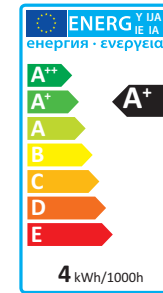

2



LED



2

LED E14

EAN-Nr. EAN-No.

Nennleistung Power
 Nennspannung Nominal voltage
 Farbtemperatur Colour temperature
 Lichtleistung Luminous flux
 Farbwiedergabeindex Rendering index Ra
 Lebensdauer Life span
 Schaltzyklen Switching cycles
 Ausstrahlwinkel Beam angle
 Sockel Socket
 Abmessung Dimensions
 dimmbar dimmable

9716

4003474285771

4 W
 220-240 V
 3000 K
 320 lm
 >80
 25 000 h
 15 000
 160°
 E14
 Ø 3,7 cm I 13 cm
 nein no

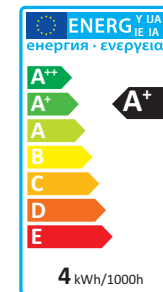

3



LED



3

LED E27

EAN-Nr. EAN-No.

Nennleistung Power
 Nennspannung Nominal voltage
 Farbtemperatur Colour temperature
 Lichtleistung Luminous flux
 Farbwiedergabeindex Rendering index Ra
 Lebensdauer Life span
 Schaltzyklen Switching cycles
 Ausstrahlwinkel Beam angle
 Sockel Socket
 Abmessung Dimensions
 dimmbar dimmable

9717

4003474285788

10 W
 220-240 V
 3000 K
 806 lm
 >80
 25 000 h
 12 500
 270°
 E27
 Ø 6 cm I 11,8 cm
 nein no



1

LED GU10

9718

EAN-Nr. EAN-No.

4003474285795

Nennleistung Power	5 W
Nennspannung Nominal voltage	220-240 V
Farbtemperatur Colour temperature	3000 K
Lichtleistung Luminous flux	350 lm
Farbwiedergabeindex Rendering index Ra	>80
Lebensdauer Life span	25 000 h
Schaltzyklen Switching cycles	12 500
Ausstrahlwinkel Beam angle	38°
Sockel Socket	GU10
Abmessung Dimensions	Ø 5 cm I 5,8 cm
dimmbar dimmable	nein no

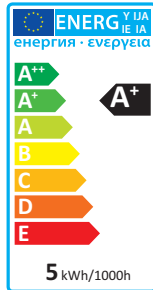

1



LED



2

LED GU10

9719

EAN-Nr. EAN-No.

4003474285801

Nennleistung Power	6 W
Nennspannung Nominal voltage	220-240 V
Farbtemperatur Colour temperature	3000 K
Lichtleistung Luminous flux	350 lm
Farbwiedergabeindex Rendering index Ra	>80
Lebensdauer Life span	25 000 h
Schaltzyklen Switching cycles	12 500
Ausstrahlwinkel Beam angle	38°
Sockel Socket	GU10
Abmessung Dimensions	Ø 5 cm I 5,8 cm
dimmbar dimmable	ja yes

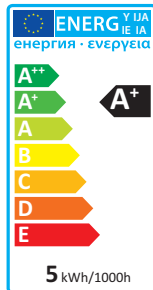

2



LED



3

LED GU5,3

9720

EAN-Nr. EAN-No.

4003474285818

Nennleistung Power	5 W
Nennspannung Nominal voltage	220-240 V
Farbtemperatur Colour temperature	3000 K
Lichtleistung Luminous flux	320 lm
Farbwiedergabeindex Rendering index Ra	>80
Lebensdauer Life span	25 000 h
Schaltzyklen Switching cycles	12 500
Ausstrahlwinkel Beam angle	110°
Sockel Socket	GU5,3
Abmessung Dimensions	Ø 5 cm I 5,3 cm
dimmbar dimmable	nein no

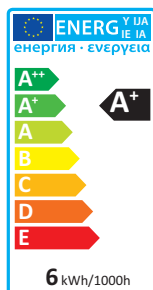

3



LED



1



LED



1

LED SMD G9**9726**

EAN-Nr. EAN-No.

4003474308364

Nennleistung Power	3 W
Nennspannung Nominal voltage	220-240 V
Farbtemperatur Colour temperature	3000 K
Lichtleistung Luminous flux	255 lm
Farbwiedergabeindex Rendering index Ra	>80
Lebensdauer Life span	25 000 h
Schaltzyklen Switching cycles	12 500
Ausstrahlwinkel Beam angle	
Sockel Socket	G9
Abmessung Dimensions	Ø 1,5 cm I 5,5 cm
dimmbar dimmable	nein no

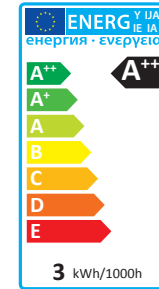

2



LED



2

LED E14**9727**

EAN-Nr. EAN-No.

4003474310725

Nennleistung Power	3 W
Nennspannung Nominal voltage	220-240 V
Farbtemperatur Colour temperature	3000 K
Lichtleistung Luminous flux	220 lm
Farbwiedergabeindex Rendering index Ra	>80
Lebensdauer Life span	25 000 h
Schaltzyklen Switching cycles	15 000
Ausstrahlwinkel Beam angle	360°
Sockel Socket	E14
Abmessung Dimensions	Ø 3,5 cm I 9,5 cm
dimmbar dimmable	nein no

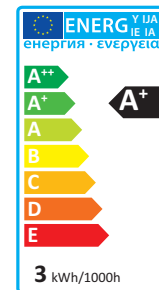

3



LED



3

LED E14**9728**

EAN-Nr. EAN-No.

4003474310732

Nennleistung Power	3 W
Nennspannung Nominal voltage	220-240 V
Farbtemperatur Colour temperature	3000 K
Lichtleistung Luminous flux	220 lm
Farbwiedergabeindex Rendering index Ra	>80
Lebensdauer Life span	25 000 h
Schaltzyklen Switching cycles	15 000
Ausstrahlwinkel Beam angle	360°
Sockel Socket	E14
Abmessung Dimensions	Ø 3,5 cm I 11,7 cm
dimmbar dimmable	nein no



1

LED E14

9729

EAN-Nr. EAN-No.

4003474310749

Nennleistung Power	3 W
Nennspannung Nominal voltage	220-240 V
Farbtemperatur Colour temperature	3000 K
Lichtleistung Luminous flux	220 lm
Farbwiedergabeindex Rendering index Ra	>80
Lebensdauer Life span	25 000 h
Schaltzyklen Switching cycles	15 000
Ausstrahlwinkel Beam angle	360°
Sockel Socket	E14
Abmessung Dimensions	Ø 4,4 cm I 7,3 cm
dimmbar dimmable	nein no

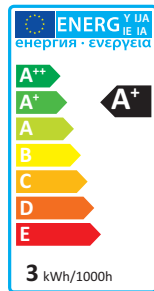

LED



2

LED E27

9730

EAN-Nr. EAN-No.

4003474310756

Nennleistung Power	7 W
Nennspannung Nominal voltage	220-240 V
Farbtemperatur Colour temperature	3000 K
Lichtleistung Luminous flux	660 lm
Farbwiedergabeindex Rendering index Ra	>80
Lebensdauer Life span	25 000 h
Schaltzyklen Switching cycles	15 000
Ausstrahlwinkel Beam angle	360°
Sockel Socket	E27
Abmessung Dimensions	Ø 6 cm I 10,8 cm
dimmbar dimmable	ja yes

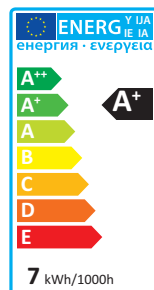

LED



3

LED E27

9731

EAN-Nr. EAN-No.

4003474310763

Nennleistung Power	9 W
Nennspannung Nominal voltage	220-240 V
Farbtemperatur Colour temperature	3000 K
Lichtleistung Luminous flux	840 lm
Farbwiedergabeindex Rendering index Ra	>80
Lebensdauer Life span	25 000 h
Schaltzyklen Switching cycles	15 000
Ausstrahlwinkel Beam angle	360°
Sockel Socket	E27
Abmessung Dimensions	Ø 9,2 cm I 12,5 cm
dimmbar dimmable	nein no

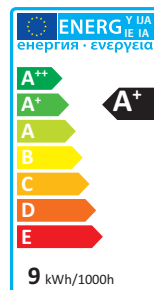

LED



1



LED



1

LED 360°**9723**

EAN-Nr. EAN-No.

4003474297880

Nennleistung Power	7 W
Nennspannung Nominal voltage	220-240 V
Farbtemperatur Colour temperature	3000 K
Lichtleistung Luminous flux	620 lm
Farbwiedergabeindex Rendering index Ra	>80
Lebensdauer Life span	25 000 h
Schaltzyklen Switching cycles	12 500
Ausstrahlwinkel Beam angle	360°
Sockel Socket	E27
Abmessung Dimensions	Ø 6 cm I 10,8 cm
dimmbar dimmable	nein no

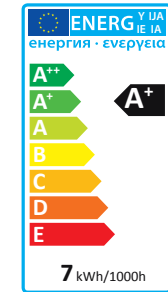

2



LED

2

RGB LED**0730****„DISCO-KUGEL“
„DISCO BALL“**

EAN-Nr. EAN-No.

4003474294766

Nennleistung Power	3 W
Nennspannung Nominal voltage	100-240 V
Lichtleistung Luminous flux	
• Rot Red	35–45 lm
• Grün Green	60–70 lm
• Blau Blue	15–25 lm
Lebensdauer Life span	20 000 h
Schaltzyklen Switching cycles	10 000
Sockel Socket	E27
Abmessung Dimensions	Ø 8 cm I 12 cm
dimmbar dimmable	nein no



Interessanter Farbwechseleffekt durch permanente Drehung des Leuchtmittels
Attractive colour changing effects by continuous rotation of the bulb

Der vorliegende Index ist nach ACTION-Serien-Nummern sortiert.
The present index participates sorted after ACTION-series-numbers.

Im Nachfolgenden handelt es sich um die Serie 003.
It is in the following about the series 003.

Serien-Nummer
Series-Number







600301010000

ACTION Artikel-Nummer
ACTION Item-Number

Series	Art-Nr. Item-No.	EAN-Nummer EAN-Number	Seite Page	Series	Art-Nr. Item-No.	EAN-Nummer EAN-Number	Seite Page	Series	Art-Nr. Item-No.	EAN-Nummer EAN-Number	Seite Page
003	600301010000	4003474263953	011	223	922305010000	4003474300887	043	328	732803640000	4003474247793	008
003	600301010150	4003474267531	010	251	425101540000	4003474300122	061	328	832801640000	4003474247809	008
003	600301640000	4003474247922	011	251	725102540000	4003474300139	061	336	433601010000	4003474300894	056
003	700304010150	4003474274041	010	251	725104540000	4003474300146	061	336	733602010000	4003474300900	056
003	800301010150	4003474274058	010	251	925103540000	4003474300153	061	336	733604010000	4003474300931	056
003	800301640000	4003474247915	011	251	925106540000	4003474300160	061	336	933603010000	4003474300948	056
003	900301010200	4003474274300	010	258	725805010000	4047494010036	004	336	933606010000	4003474300955	056
021	602101010300	4260014065761	006	258	725809010000	4047494011217	004	342	834201010120	4003474248844	029
021	602101010500	4047494018889	006	264	626401640300	4047494019015	007	342	834201640120	4003474244990	029
021	802101010300	4260014065778	006	264	626401640400	4047494019022	007	345	734504640000	4003474286440	014
050	705001640000	4003474308067	013	264	826401060200	4047494019107	007	345	734504640500	4003474289311	014
071	307101640000	4003474283388	035	269	426901010000	4003474281261	063	349	234901109000	4003474262406	025
071	307102640000	4003474283395	035	269	726902010000	4003474281278	062	349	234901509000	4003474262437	025
071	407101640000	4003474283326	064	269	726904010000	4003474281285	062	349	834901109000	4003474262451	025
071	707102640000	4003474283333	064	269	926903010000	4003474291666	063	349	834901509000	4003474262482	025
071	907103640000	4003474284354	064	269	926906010000	4003474289557	062	357	635701010000	4003474246420	005
071	907104640000	4003474283357	064	269	926906011000	4003474281292	062	357	935703010000	4003474246413	005
071	907106640000	4003474283364	064	284	328402061200	4003474245980	009	367	336702640000	4003474281643	039
084	308401010000	4003474260112	037	284	628401061200	4003474245997	009	367	436701640000	4003474281186	055
092	809201640000	4003474281742	030	284	828401061160	4003474246000	009	367	736702640000	4003474281193	055
132	913201060300	4003474281162	049	294	329401010000	4260014061695	036	367	736704640000	4003474283760	055
132	913201060400	4003474281179	049	307	830701640170	4047494018346	028	367	936701640000	4003474283739	041
141	814101320500	4047494016847	026	307	830701640330	4047494018353	028	367	936706640000	4003474281223	055
141	814101640500	4260014066911	026	307	830701649170	4003474289656	028	376	937601640300	4003474273723	046
168	816801060000	4003474267166	021	322	832201100000	4003474305356	027	383	838301020000	4047494011316	032
168	816801100000	4003474267258	021	322	832201700000	4003474305363	027	383	838301320000	4047494010548	032
168	816801700000	4003474267265	021	322	832201900000	4003474305998	027	383	838301640000	4260014063972	032
169	916901060000	4003474294483	041	324	832401060000	4003474257549	033	383	838301645000	4047494010531	032
190	319001640000	4003474283647	034	324	832401100000	4003474256757	033	388	438801640000	4003474273198	059
221	922101060250	4003474281254	049	324	832401500000	4003474256740	033	388	738802640000	4003474273204	059
223	422301010000	4003474300849	043	324	832401510000	4003474256764	033	388	938803640000	4003474273211	059
223	922304010000	4003474300870	043	328	632801640000	4003474247786	008	388	938804640000	4003474273228	059

Series	Art-Nr. Item-No.	EAN-Nummer EAN-Number	Seite Page	Series	Art-Nr. Item-No.	EAN-Nummer EAN-Number	Seite Page	Series	Art-Nr. Item-No.	EAN-Nummer EAN-Number	Seite Page
388	938806640000	4003474273235	059	571	857101100000	4003474274362	024	794	479401880500	4003474298382	073
406	940605010000	4003474281605	052	572	857201060000	4003474274393	024	794	679401060000	4003474298399	073
406	940605011000	4003474284040	052	572	857201100000	4003474274409	024	853	485301640000	4003474304663	060
406	940610010000	4003474281612	052	575	857501640000	4003474273273	029	853	785302640000	4003474304670	060
406	940610011000	4003474284057	052	579	857901640000	4047494017981	028	853	785304640000	4003474304687	060
436	743602640000	4003474277844	012	583	758304640000	4003474281858	015	853	985303640000	4003474304694	060
436	743603640000	4003474277851	012	634	463401010000	4003474251363	065	853	985306640000	4003474299839	060
436	843601640000	4003474277868	012	634	763402010000	4003474251370	065	861	986105010000	4003474277783	053
444	844401320000	4003474293080	030	634	763404010000	4003474251387	065	861	986105011000	4003474278353	053
444	844401640000	4003474293097	030	634	963406010000	4003474265001	065	866	286601640000	4047494018322	022
458	645801640000	4047494018483	016	654	865401320000	4003474280912	031	871	487101010000	4003474305646	042
458	745803640000	4047494018506	016	654	865401640000	4003474280905	031	871	987104010000	4003474284316	042
458	745804640000	4047494018513	016	670	967001630330	4003474279664	046	871	987104640000	4003474296685	042
465	746504640000	4003474271385	013	672	967201630300	4003474279688	046	871	987109640000	4003474296692	042
469	846901060000	4003474305424	019	677	467701540000	4003474289366	058	876	987601630260	4003474264516	047
469	846901100000	4003474305431	019	677	767702540000	4003474289182	058	876	987601630330	4003474264523	047
470	847001060000	4003474291895	020	677	767704540000	4003474289199	058	876	987601630400	4003474263939	047
470	847001100000	4003474291901	020	677	967703540000	4003474289243	058	881	988101700250	4003474278537	048
470	847001700000	4003474291918	020	677	967706540000	4003474289250	058	881	988101700330	4003474278544	048
474	847401320000	4003474277691	031	702	870201700000	4003474307541	019	881	988101701350	4003474287843	048
474	847401640000	4003474277707	031	708	370801700000	4003474307534	034	885	888501100000	4003474298283	017
478	847801640000	4003474300238	030	709	370905010000	4260014061497	037	901	890112100000	4047494018308	023
493	749301640000	4003474281568	015	714	371401970000	4003474296876	069	902	890212060000	4047494018315	023
499	949905010000	4003474265551	051	714	471401970000	4003474296869	069	903	290312060000	4047494018278	023
503	450301010000	4003474267852	066	714	471401970500	4003474296852	069	903	290312100000	4047494018285	023
503	450301640000	4003474289090	067	716	371601970000	4003474296883	068	929	992905060000	4003474245560	054
503	750302010000	4003474267869	066	716	471601970000	4003474296890	068	929	992910060000	4003474245553	054
503	750302640000	4003474289106	067	717	871701100000	4047494011972	022	999	0730	4003474294766	080
503	750303010000	4003474267876	066	717	871701290000	4047494011965	022	999	9705	4003474274799	074
503	750303640000	4003474289113	067	717	871701700000	4047494011989	022	999	9706	4003474277554	074
503	750304010000	4003474274546	066	724	372401970800	4003474296913	071	999	9710	4003474279282	074
503	750304640000	4003474289120	067	724	472401970000	4003474296920	071	999	9712	4003474285733	075
503	950306010000	4003474278391	066	724	472401970510	4003474296944	071	999	9713	4003474285740	075
503	950306640000	4003474289137	067	746	374602320000	4003474290089	038	999	9714	4003474285757	075
516	451601010000	4003474295602	057	746	374602640000	4003474286457	038	999	9715	4003474285764	076
516	751602010000	4003474295619	057	754	475401640000	4003474281438	044	999	9716	4003474285771	076
516	751604010000	4003474295626	057	754	975401640000	4003474281445	044	999	9717	4003474285788	076
516	951606010000	4003474295640	057	754	975401640300	4003474281452	045	999	9718	4003474285795	077
530	853001010250	4003474294360	018	754	975401641300	4003474281476	045	999	9719	4003474285801	077
530	853001010350	4003474294377	018	766	476601880000	4003474298313	070	999	9720	4003474285818	077
534	353402640000	4003474277684	039	766	476601880500	4003474298320	070	999	9723	4003474297880	080
562	956205010000	4003474300306	050	767	976701060300	4003474279695	051	999	9726	4003474308364	078
562	956209010000	4003474300313	050	772	277201640000	4047494018339	022	999	9727	4003474310725	

Serie Series	Name Name	Serie Series	Name Name	Serie Series	Name Name
465	ALVA	903	FLEX	269	NANTES
388	ALVIS	284	FLORENZ	572	NEVIS
575	AMBER	003	FUTURA	221	NOA
654	ANIQUE	569	GENUA	071	NOIS
866	ARCOS	050	GWEN	853	OAK
579	BARNEY	672	HALDEN	383	OKTO
677	BAS	570	HOLM	670	OSLO
534	BERIT	503	HOORN	342	PLUTO
294	BOW	349	JOS	766	QUEENS
562	BROOKS	746	KENTO	132	RENNES
861	CALI	322	LANETT	571	REYK
357	CARREE	708	LAUREL	881	SANA
714	CENTRAL	251	LESTER	084	SANDER
324	CESENA	307	LOFT	169	SOLENA
499	COLINA	754	LORENZ	634	SOLUTION
328	COLLAGE	516	LUGO	264	TOLEDO
470	COLLO	530	LUND	493	TOURS
717	CORBY	436	MAINE	469	TUBAC
772	COTTO	794	MANHATTAN	478	VARESE
258	CRYSTAL	876	MARA	871	VENETA
021	DAKOTA	458	MAX	345	VERSO
583	DIJON	767	MERLE	929	VISION
885	ELYSSA	092	METZ	709	WIDNES
702	FAIR	168	MIKA	190	ZEN
724	FERRY	376	MILA	406	ZOE
716	FIELD	367	MONZA		
141	FLAME	223	MOODY		
901	FLEX	336	MORGAN		
902	FLEX	474	MORLEY		

						
01	Chrom	Chrome	Chrome	Cromo	Chrom	хромированный
02	Messing-gefärbt	Coloured brass	Imitation laiton	Latón-teñido	Mosiądz zafarbowany	цветная латунь
06	Weiß	White	Blanc	Blanco	Biały	белый
10	Schwarz	Black	Noir	Negro	Czarny	чёрный
29	Blau	Blue	Bleu	Azul	Niebieski	голубой
32	Messing-matt	Brass matt finished	Laiton mat	Latón-mate	Mosiądz matowy	матовая латунь
50	Grau	Grey	Gris	Gris	Szary	серый
51	Hellbraun	Light brown	Marron clair	Castaño claro	Jasny brąz	коричневый
63	Aluminium gebürstet	Aluminium brass finished	En couleur nickel	Aluminio satinado	Aluminium	матовый алюминий
64	Nickel-matt	Nickel matt finished	Nickel mat	Níquel-mate	Stal matowa	матовое железо
70	Silber	Silver	Argent	Plata	Srebrny	серебряный
88	Anthrazit	Dark grey	Gris foncé	Gris oscuro	Antracytowy	тёмно-серый
97	Edelstahl gebürstet	Stainless steel brushed	Acier brossé	Acero inoxidable cepillado	Stal szczotkowana	матовая высококачественная сталь