

LEUCOS

idea

studio

modo

LEUCOS

idea

P. 14-217

studio

P. 218-405

modo

P. 406-547

collection

idea



ALMA
16



APORIA
20

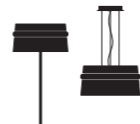

ARO
22



AYERS
28



BISQUIT
34



BLOCK
36



CELINE
42



CLOCHE
48



COLAGE
58

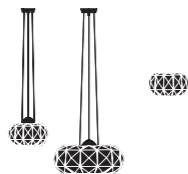

DELUXE
62



DIANE
66



DISK
70



GILL
72



GLOSSY
74



GOLF
78

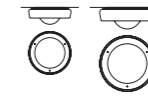

JELLYFISH
86



KATERINA
88

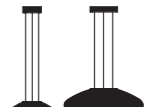

KEYRA
90



KON
94

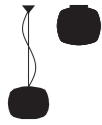

KUBE
96



KUK
100

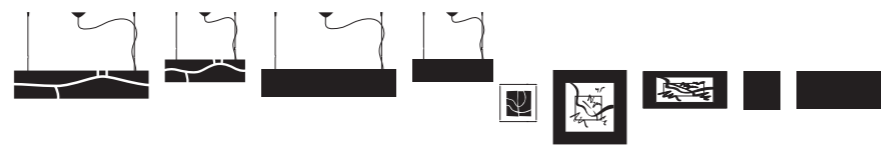

LAGUNA
108



MERCURE
130



MICENE
134



MILD
136



MODULO
140



NUBIA
144



LINK
118



LOOP
120

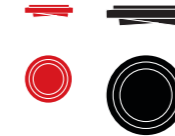

LOOP-LINE
122



MANHATTAN
126



ONY
148

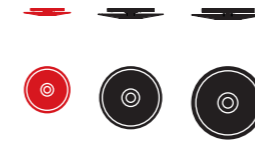

PLANET
150



SAIL
156

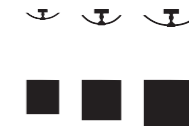

SELIS
158

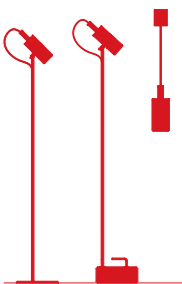

SHAKER
162

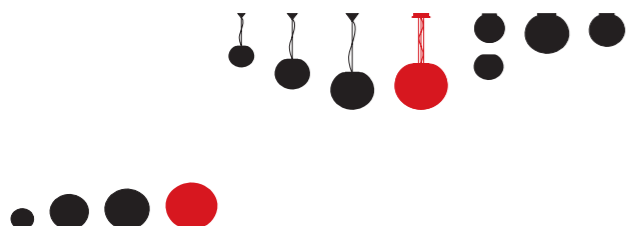

SPHERA
170



SPORE
178



SPRING
180

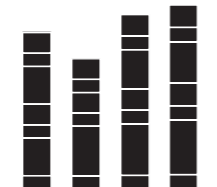

STACKING
182



STONE
186



SUMMER
188



TODD
190

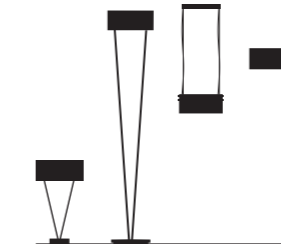

VITTORIA
192



VIVIA
202

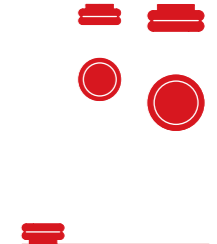

WIMPY
208



WITCH
214

collection

idea

table

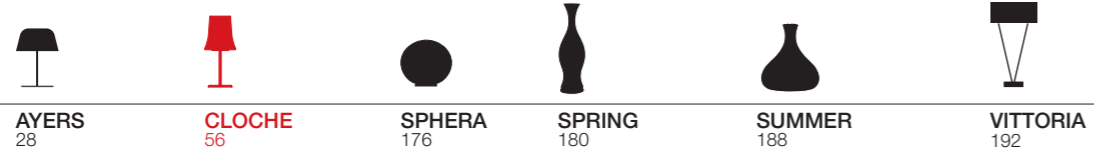

floor

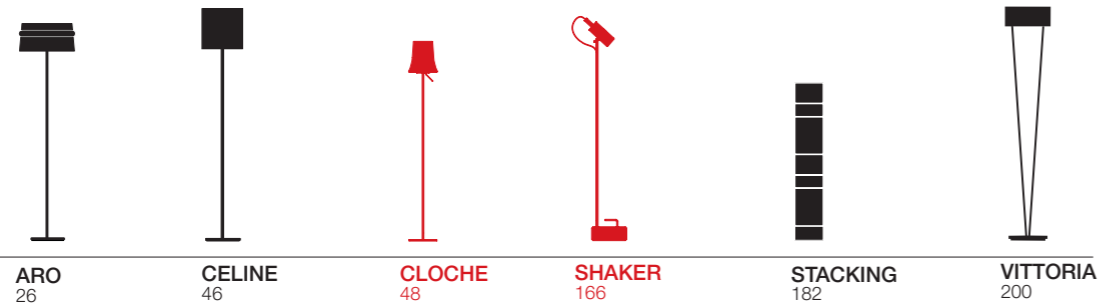

suspension

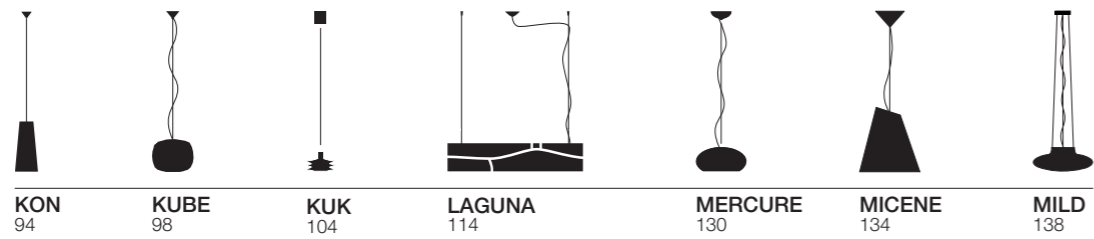
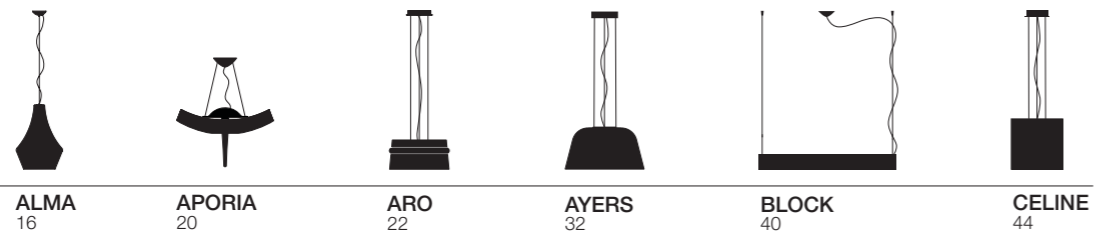

wall/ceiling

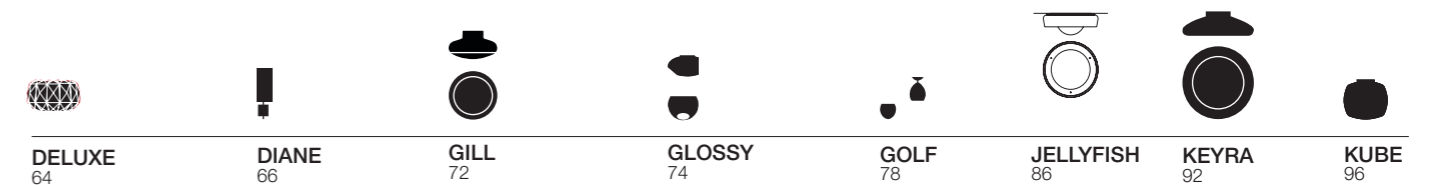
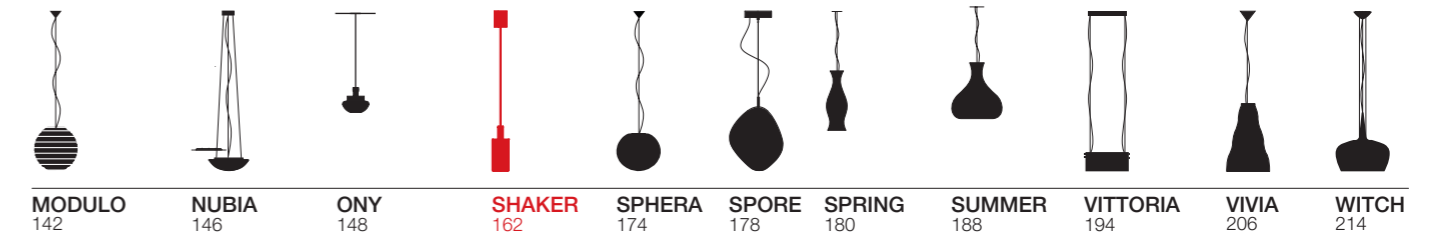
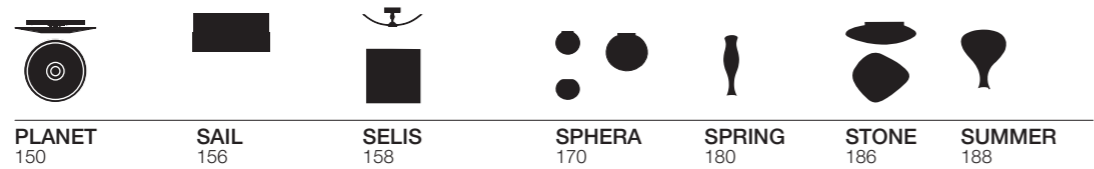
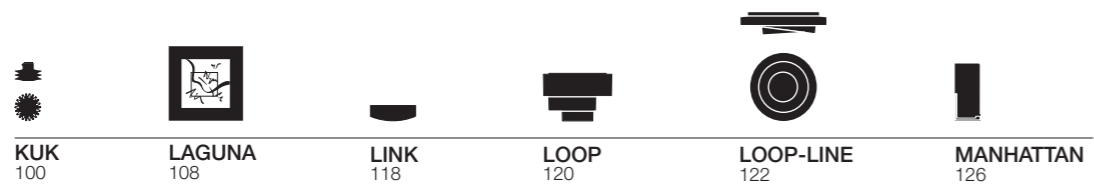
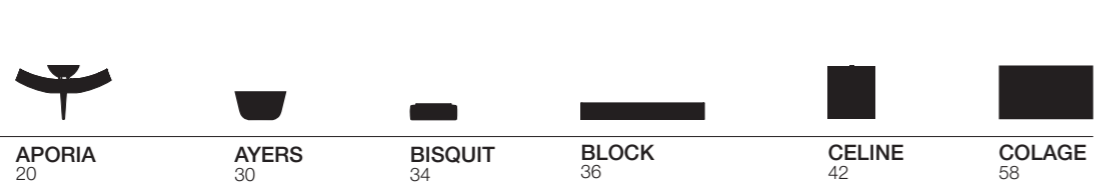

collection

studio

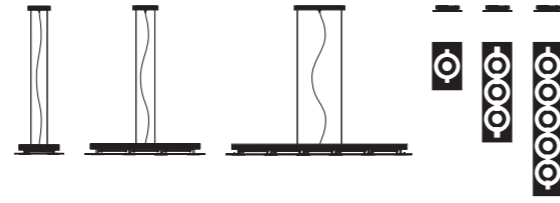

O-SOUND
220



AIR
230



AKI
234

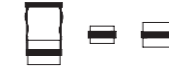

ALA
238



ALIAS
242



ARIA
248



AXEL
252

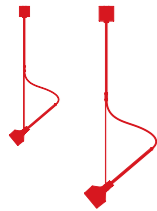

BEAMER
256



BLUMA
266



CLASS
268

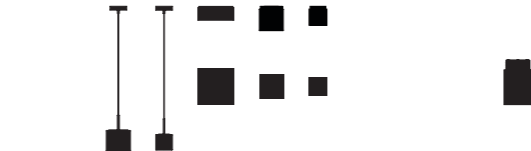

CUBI
274



DOT
280

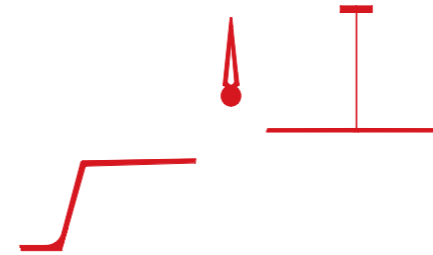

FLECHA
284



GIÒ-MINIGIÒ
294

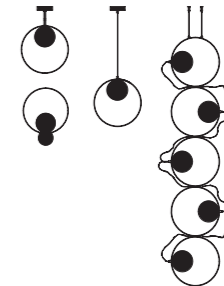

GIUKÓ
300



ISIS
306

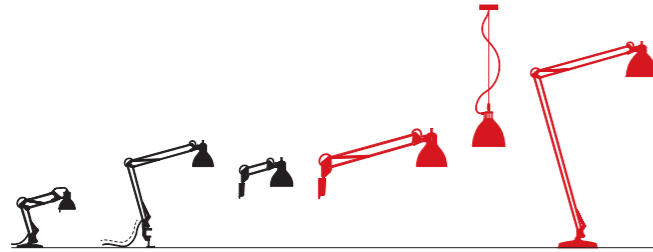

JJ
308

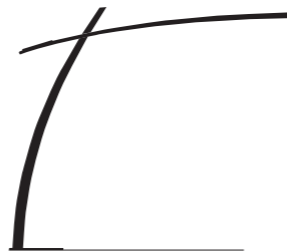

KATANA
332



LEVA
338



LILITH
344



MIRAGE
354



ONE
358



REGENCY
364



RISE
372



SOLENERO
376



SYDNEY
378

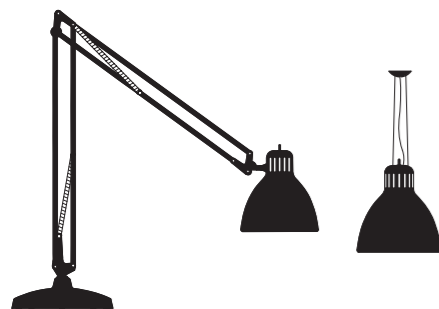

THE GREAT JJ
310



TRECENTOESSANTAGRADI
386

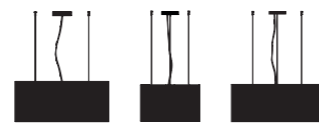

VANITY
392

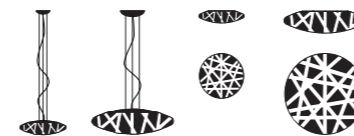

X-RAY
400



SD GHIBLI
368



SD LIBO
370

collection

studio

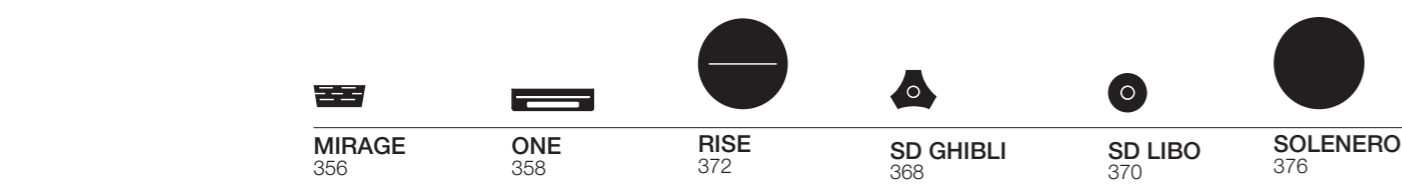
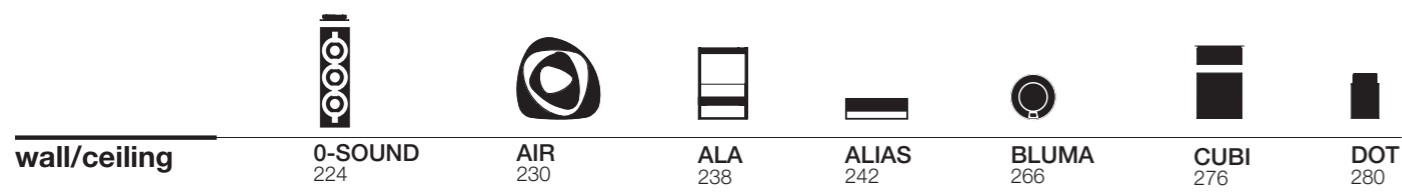
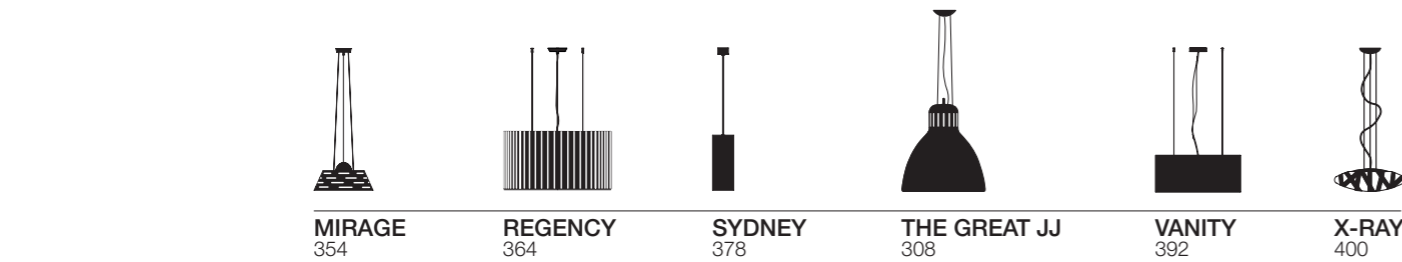
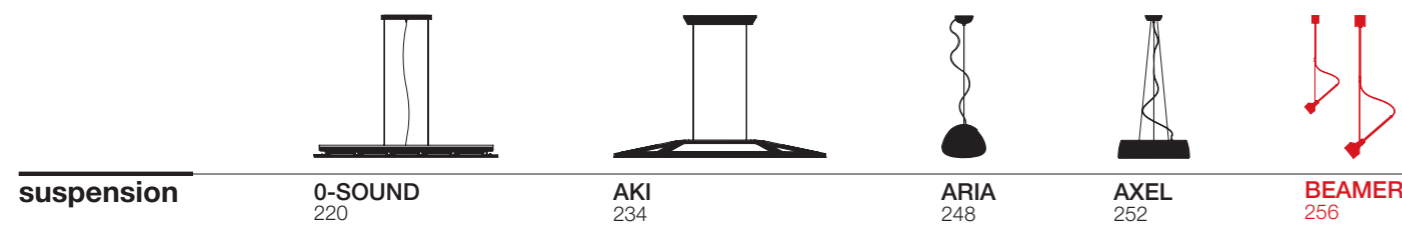
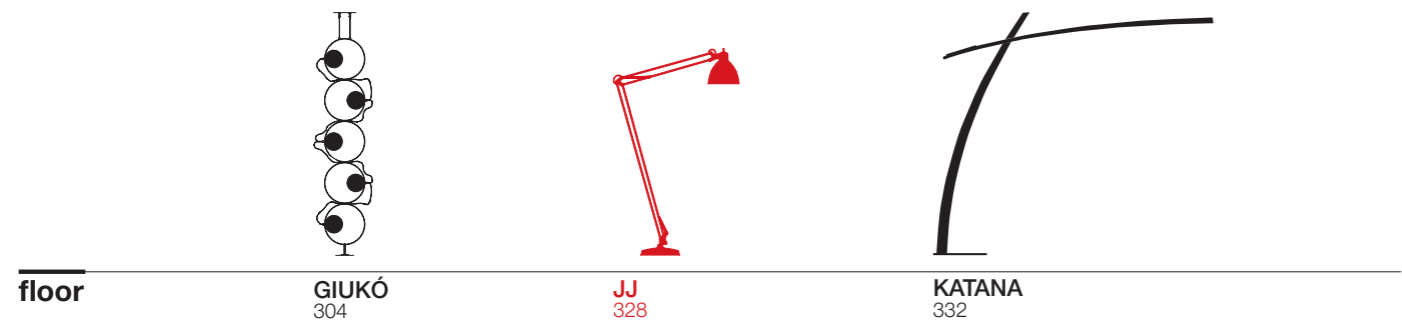
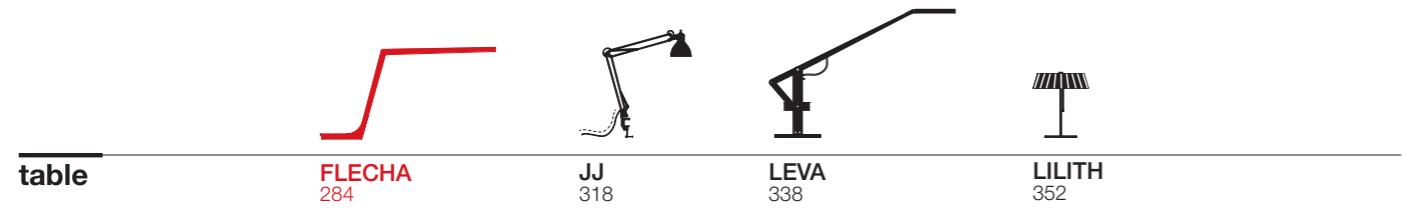

THE GREAT JJ
312

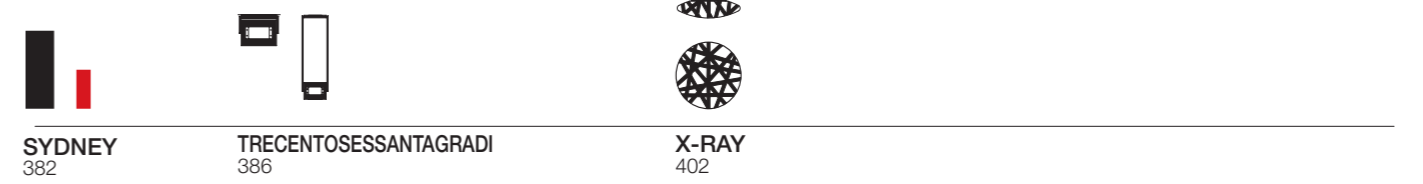
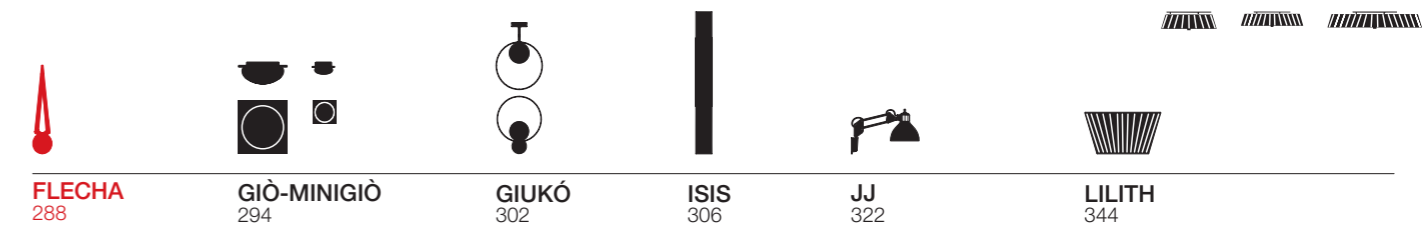
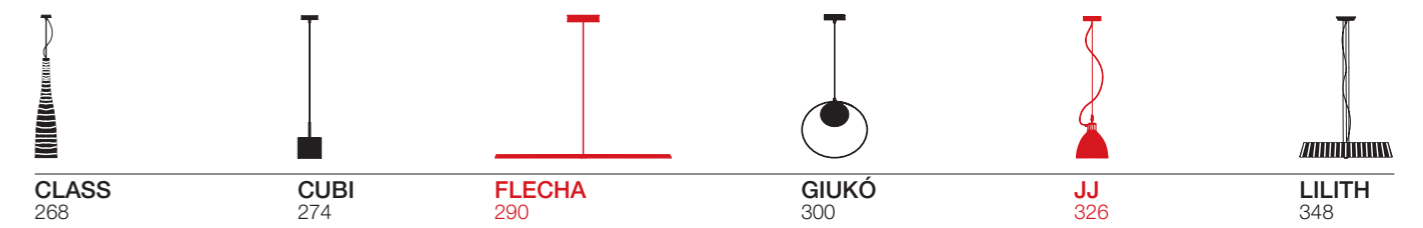

collection

modo



ACQUALUCE
408

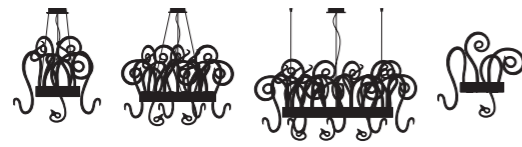

ASPID
412



ATELIER
418



ATHENA
424

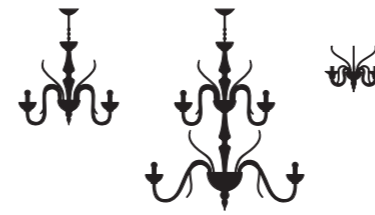

BELZEBÙ
426



BOLERO
430



CHARME
440

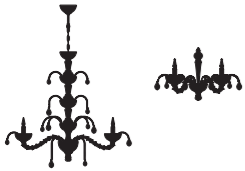

COUTURE
448



DANIELI
454



DIAMANTE
458



DRACENA
460

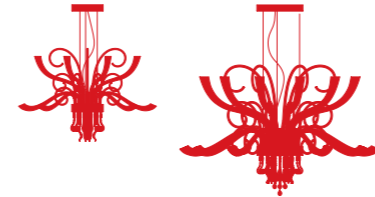

ELYSÉE
470



ELYSÉE
466

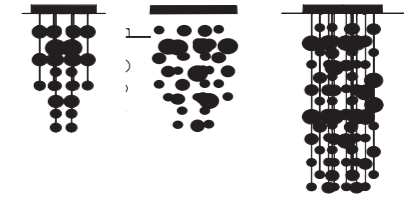

ETHER
474



FAIRY
486

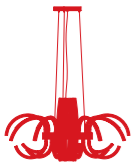

FILUX
492



GLÒ
496



IXI
502



NIA
510



OLANDESE
518



ORLEANS
520



PASCALE
528

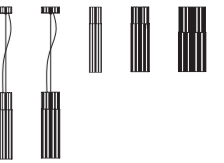

REED
530

collection

modo



ACQUALUCE
408



ASPID
412



ATELIER
422



ATHENA
424



BELZEBÙ
426



BOLERO
430



CHARME
444



COUTURE
448



DANIELI
454

suspension



DRACENA
460

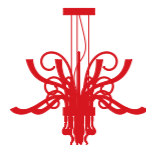

ELYSÉE
470



FILUX
492



OLANDESE
518



ORLEANS
520

wall/ceiling



ASPID
416



ATELIER
418



BELZEBÙ
428



BOLERO
432



CHARME
440



COUTURE
452



DANIELI
456



DIAMANTE
458



DRACENA
464



ELYSÉE
466



ORLEANS
524



PASCALE
528

Pendants with custom capabilities

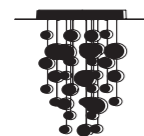

ETHER
474



FAIRY
486



GLÒ
496



IXI
502



NIA
510



REED
530

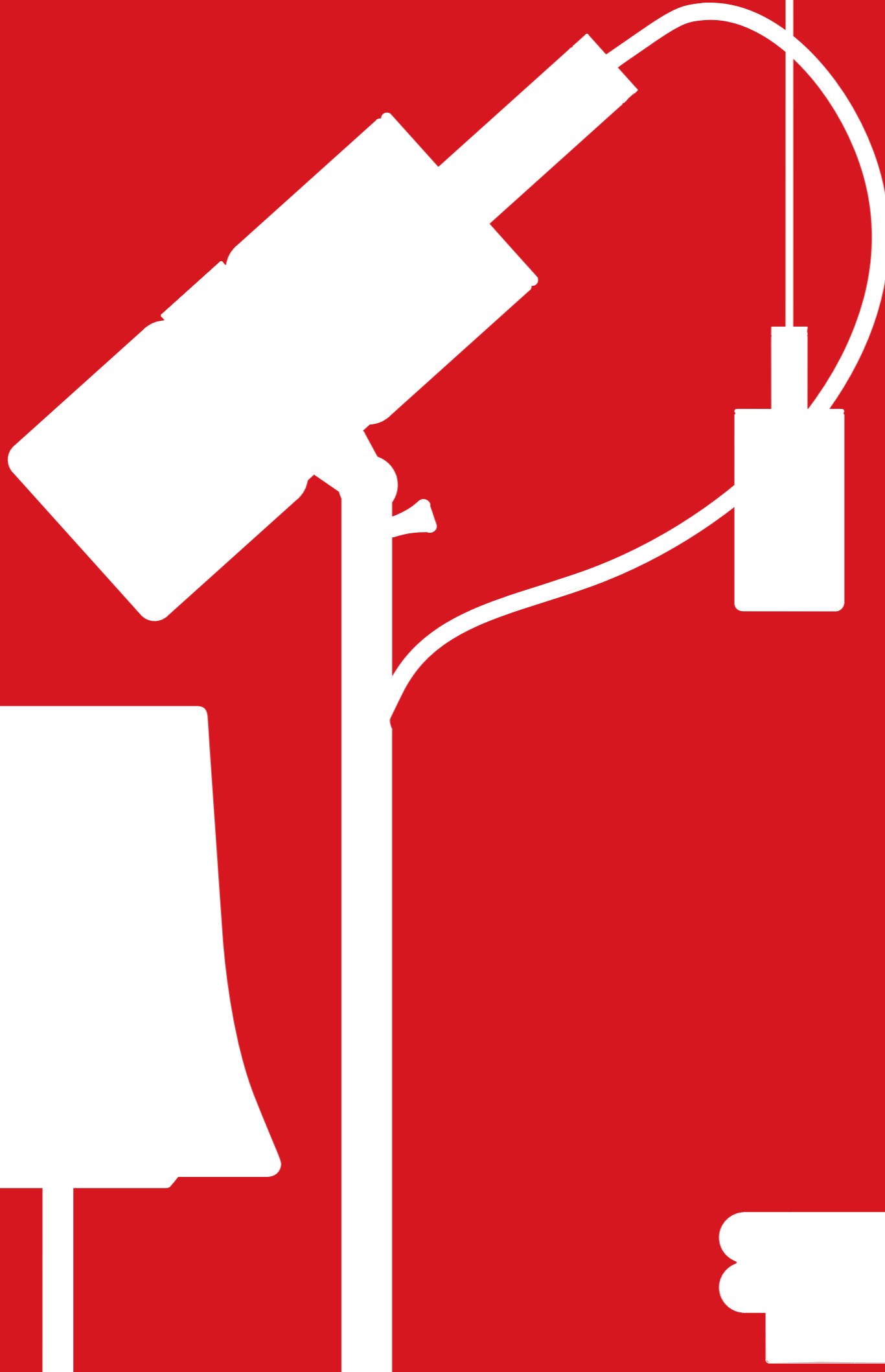



A striking and graceful bell shaped pendant features a mouth blown layered glass diffuser available in two colors: white on white or black on white. The glass diffuser is supported to the structure with steel cable and clear cord.

ALMA 30 S

Colors



1 x 60W-E12



Certifications

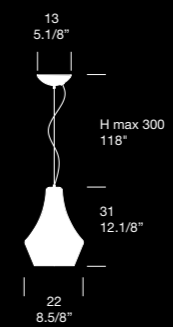

ALMA

DESIGN / RICCARDO GIOVANETTI





A striking and graceful large scale bell shaped pendant features a mouth blown layered glass diffuser available in two colors: white on white or black on white. The glass diffuser is supported to the structure with steel cable and clear cord.

ALMA 60 S	
Colors	<input checked="" type="radio"/> <input type="radio"/>
1 x 75W-E26	
1 x 18W-G24q2	
Certifications	

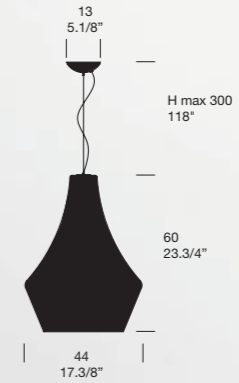

ALMA

DESIGN / RICCARDO GIOVANETTI



APORIA PL

Color

1 x 55W-T5-2GX13

LED 1 x 7W-GU10

Certifications 

APORIA S

Color

1 x 55W-T5-2GX13

LED 1 x 7W-GU10

Certifications 

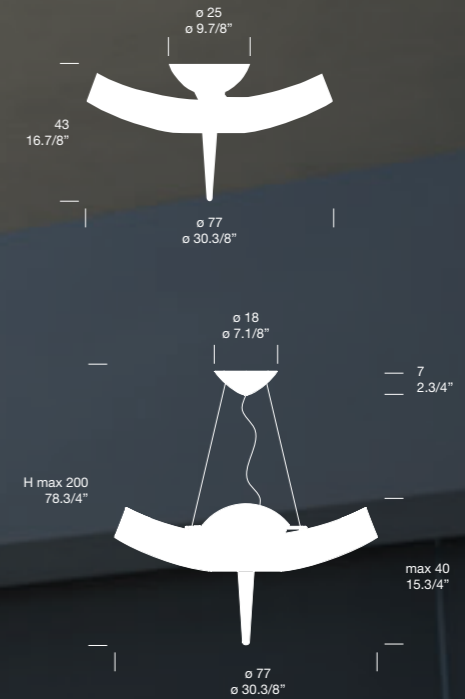

APORIA

DESIGN / R. TOSO, N. MASSARI & ASSOCIATES WITH G. TOSO

Large scale ceiling design in white slumped glass. The special decorative glass element is handcrafted in solid crystal and submerged in 24K gold leaf. The ceiling design can be separately switched for special effect. Structure in matte white finish.

ARO

DESIGN / JORGE PENSI



ARO

DESIGN / JORGE PENSI

ARO (Suspension)

Colors



1 x 55W T5-C 2GX13



3 x 75W-ECO-E26



Certifications

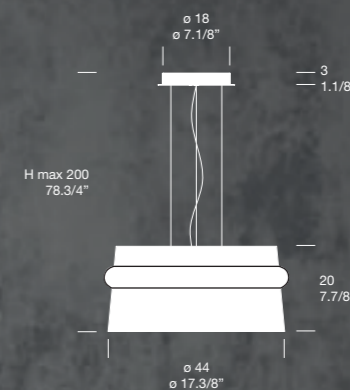

Beautiful, large-scale suspension design in blown Venetian crystal with a mirror-smoked chrome or gloss black finish. Structure in matte white finish.



ARO

DESIGN / JORGE PENSI

ARO (Floor)

Colors



3 x 75W E26



Certifications



Floor lamp with a hand-blown, clear crystal glass diffuser with a mirror-smoked, chrome finish or gloss black finish. Polished chrome metal stem and base.



AYERS

DESIGN / MARCO PIVA



Table lamp available in two sizes composed of a hand blown glass shade in gloss black, gloss white. Metal structures with white or black painted finishes to match diffuser.

AYERS T19

Color

1 x 60W-E12

Certifications

AYERS T38

Color

1 x 75W-E26

Certifications

AYERS T19

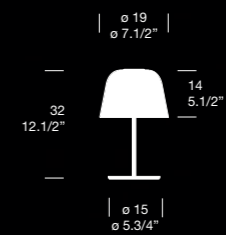

AYERS T38

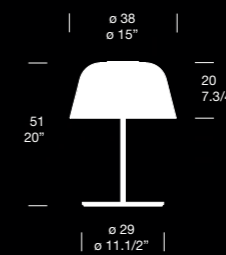



Clean lined wall sconce highlighted by a hand blown glass diffuser available in two color: glossy white or glossy black. A white metal back plate and base metal detail in polished chrome supports the glass diffuser. Companion pendant, ceiling and table designs also available.

AYERS

DESIGN / MARCO PIVA



AYERS P38

Color

2 x 100W-E26

2 x 18W-G24q2

Certifications



AYERS

DESIGN / MARCO PIVA



AYERS S38	
Color	<input type="radio"/> <input checked="" type="radio"/>
1 x 75W-E26	
1 x 18W-G24q2	
Certifications	
AYERS S	
Color	<input type="radio"/> <input checked="" type="radio"/>
1 x 75W-E26	
1 x 18W-G24q2	
Certifications	

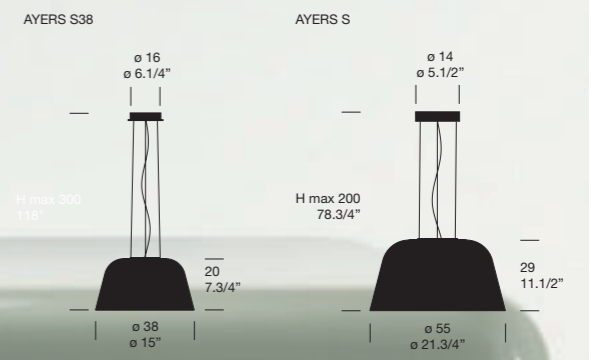

Large scale striking hand-blown Murano glass diffuser composed of two inner layers of white mouth blown glass and then two additional layers of either gloss black or gloss white glass. The diffuser is suspended by three steel cables that attaches to a circular brushed nickel canopy Companion pendant, ceiling, wall and table designs also available.



BISQUIT

DESIGN / IIKKA SUPPANEN

BISQUIT PP

Color

3 x 40W-E12

2 x 18W-G24q2

Certifications

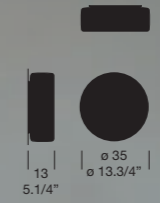

A flat, cylindrical gloss white hand blown diffuser highlights this simple design. The glass diffuser is secured to a metal structure with a decorative brushed nickel plate.

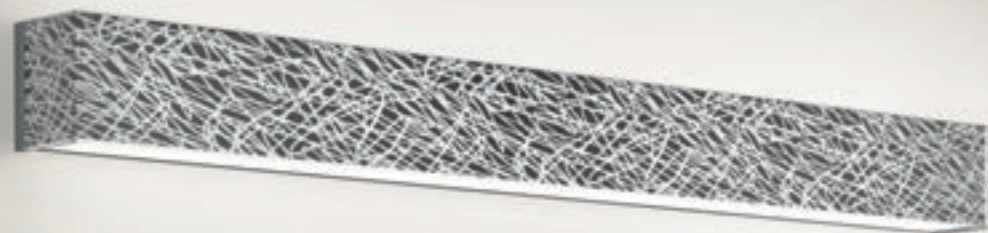

BLOCK



DESIGN / LEUCOS DESIGN TEAM



BLOCK P100

Colors

2 x 39W G5 T5

Certifications   

DIMMABLE BALLAST AVAILABLE UPON REQUEST.
LED OPTION ALSO AVAILABLE.

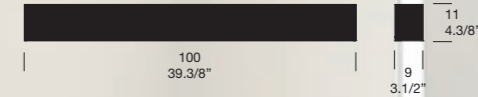

The Block P 100 is a sleek, rectangular wall sconce composed of beautifully silk-screened glass with several pattern options available: platinum with a 3D effect, all white glass, platinum on white. Fixture is mounted on a titanium painted steel structure. Companion wall, pendant designs also available

BLOCK

DESIGN / LEUCOS DESIGN TEAM



BLOCK P14

Colors

1 x 60W-G9

Certifications

BLOCK P29

Colors

2 x 60W G9

1 x 18W G24q-3

Certifications

DIMMABLE BALLAST AVAILABLE UPON REQUEST.
LED OPTION ALSO AVAILABLE.

BLOCK P14

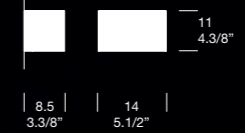

BLOCK P29

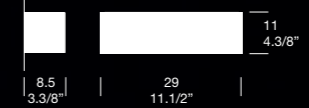

Wall sconce available in two sizes and three colors: gloss white and scribble pattern in platinum or bronze. Its light source creates a lustrous glow. The metal backing structure has a painted white finish. Block P14 and 29 are ADA compliant.

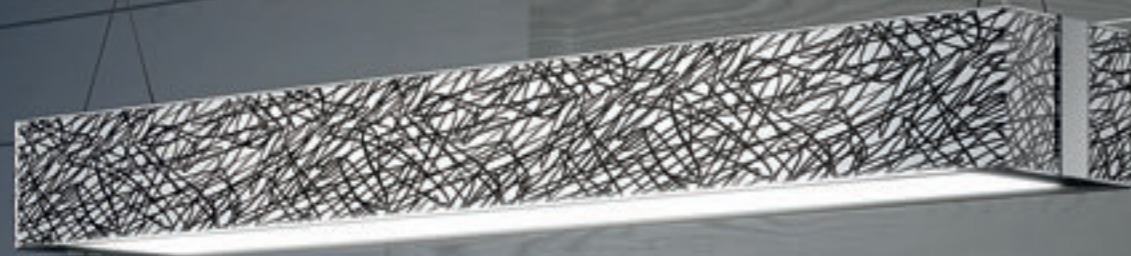

The Block S100 is a sleek, rectangular pendant fixture composed of two beautifully silk-screened glass available in three color combinations: platinum with a 3D effect, platinum on white and all white. Available with optional dimmable ballast. Companion wall designs also available.

BLOCK S100

Colors



2 x 39W G5-T5



Certifications



DIMMABLE BALLAST AVAILABLE UPON REQUEST.
LED OPTION ALSO AVAILABLE.

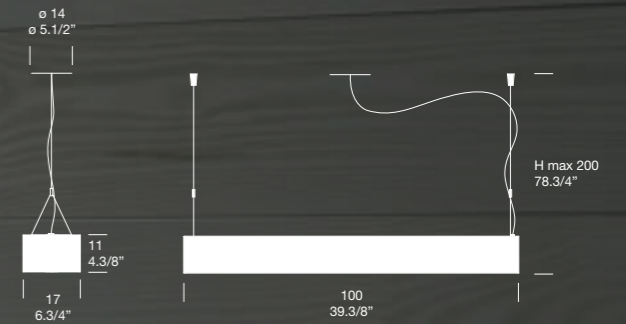







BLOCK

DESIGN LEUCOS DESIGN TEAM











CELINE P35

- Color ○
- 1 x 100W-E26 
- 2 x 13W-G24q1 
- 2 x 18W-G24q2 
- Certifications   

CELINE P

- Color ○
- 1 x 100W-E26 
- 2 x 13W-G24q1 
- 2 x 18W-G24q2 
- Certifications   

DIMMABLE BALLAST AVAILABLE UPON REQUEST.
LED OPTION ALSO AVAILABLE.

CELINE P35



CELINE P



CELINE

DESIGN / LEUCOS DESIGN TEAM

Clean-lined wall sconce offers a timeless silhouette of cylindrical satin white blown glass. The glass diffuser is secured at its base with a painted titanium metal support. Companion pendant, table and floor designs also available.





CELINE S35	
Color	<input type="radio"/>
1 x 75W-E26	
1 x 18W-G24q2	
Certifications	
CELINE S	
Color	<input type="radio"/>
1 x 75W-E26	
1 x 18W-G24q2	
Certifications	

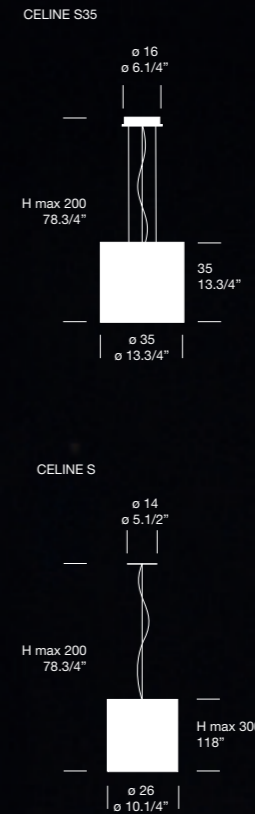

Large scale simple, drum-shaped blown glass diffuser in satin white floats from cable and cord on this clean lined pendant. Available in two sizes. The diffuser is suspended by three steel cables that attaches to a circular brushed nickel canopy Companion wall, table and floor designs also available.

CELINE

DESIGN / LEUCOS DESIGN TEAM





Stately floor lamp with cylindrical blown glass diffuser in satin white. The glass diffuser provides diffused illumination from an incandescent light source. The circular base and stem in brushed nickel supports the glass diffuser. On on/off switch is provided on the black cord. Companion wall, table, pendant designs also available.

CELINE TR35

Color



1 x 75W-E26



Certifications

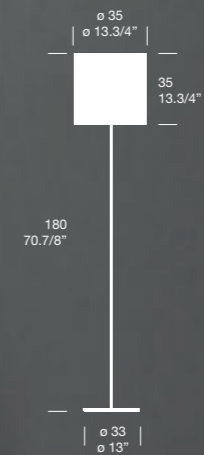

CELINE

DESIGN / LEUCOS DESIGN TEAM

CLOCHE

DESIGN / DANILO DE ROSSI





CLOCHE TR

Colors



1 x 150W E26 (Halostar) + dimmer provided



Certifications

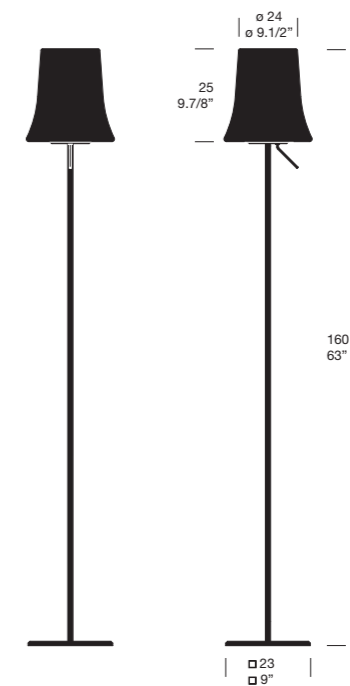

The Cloche Floor is composed of clear glass with a shiny copper or chrome coating and inner frosted glass cylinder. The clear glass combined with either of the exterior finishes creates a two-tone effect noticeable when the light is turned on. The single stem is mounted on a square, rust or anthracite painted base. Dimmer provided on cord.

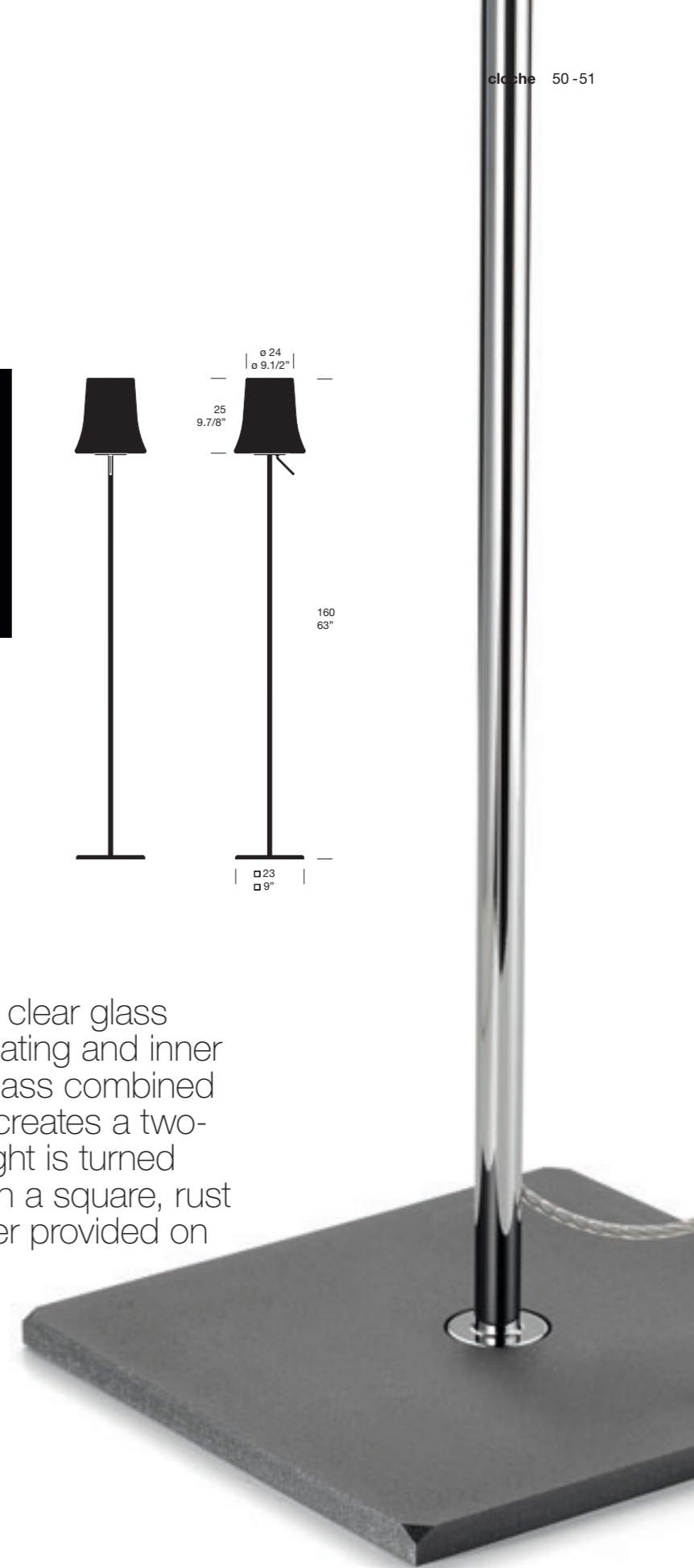



The Cloche Pendant is composed of clear glass with a shiny copper or chrome coating and inner frosted glass cylinder. The clear glass combined with either of the exterior finishes creates a two-tone effect noticeable when the light is turned on.

CLOCHE S

Colors



1 x 75W E26 (Halostar)



Certifications

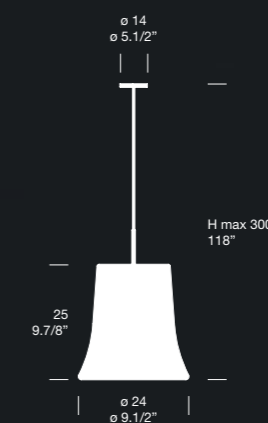

CLOCHE

DESIGN / DANILO DE ROSSI





CLOCHE

DESIGN / **DANILO DE ROSSI**

This simple and charming table lamp is part of the Cloche collection. Composed of clear glass with a shiny copper or chrome coating and inner frosted glass cylinder. The clear glass combined with either of the exterior finishes creates a two-tone effect noticeable when the light is turned on. The stem is secured to a square rust or anthracite painted base. On/off switch on cord

CLOCHE T

Colors



1 x 40W G9



Certifications

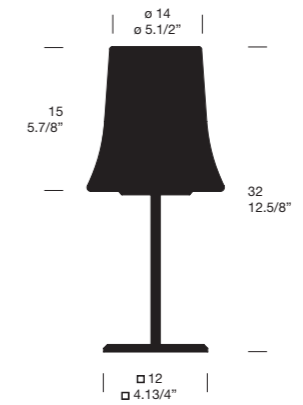



COLAGE

DESIGN / DANILO DE ROSSI

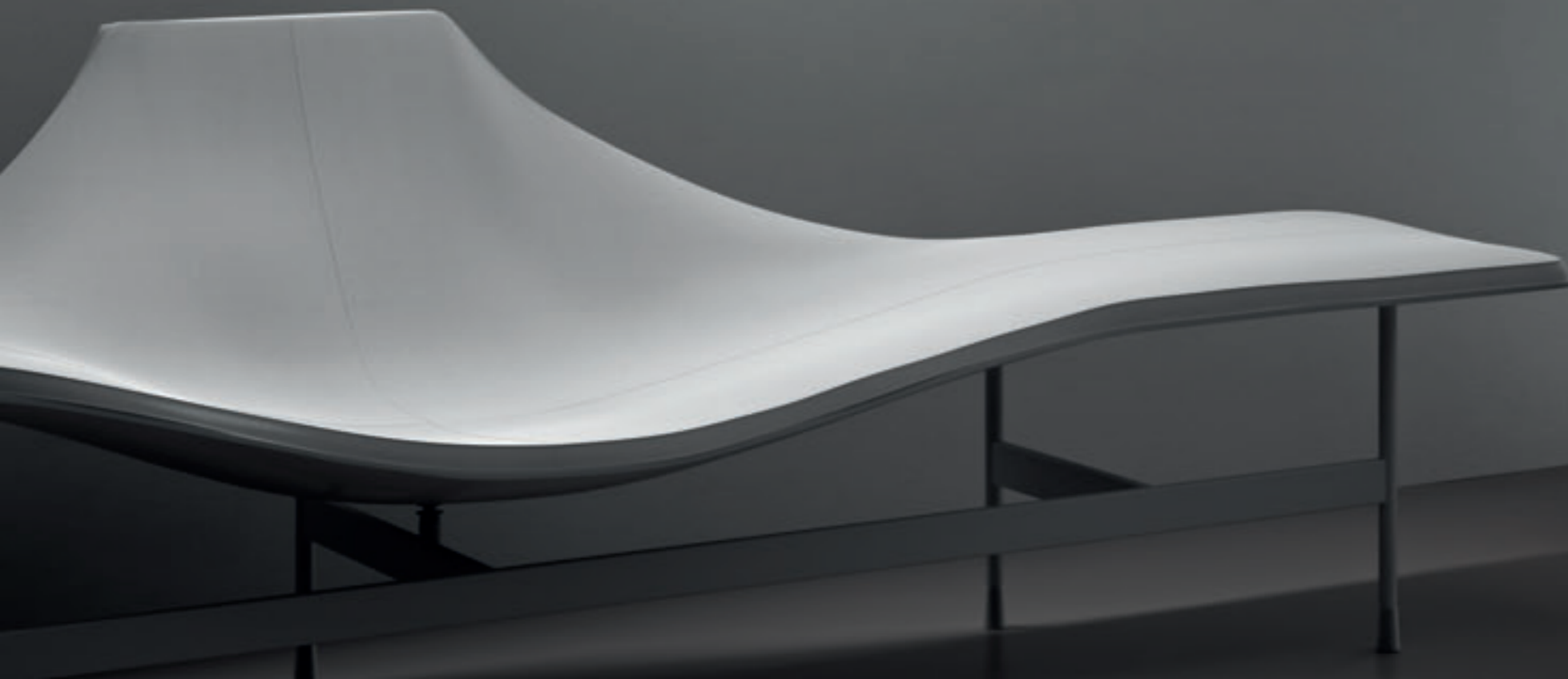



COLAGE

Colors



2 x 36W-2G11



Certifications



DIMMABLE BALLAST AVAILABLE UPON REQUEST

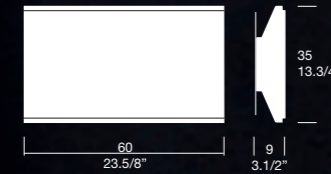

Artistic wall sconce with a decorative, hand-rolled glass panel base embedded with glass strips in two color combinations; silky white with opaque white decorations or silky white with opaque grey details. Structure in polished chrome finish.



DELUXE

DESIGN / ARCHRIVOLTO



DELUXE 35S

Colors



1 x 150W-R7s (Short)



Certifications



DELUXE 50S

Colors



1 x 200W-R7s (Long)



Certifications



DELUXE 35S

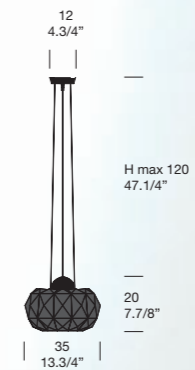

DELUXE 50S

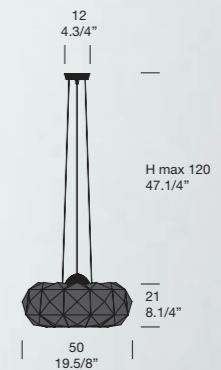

Pendant design featuring geometrically patterned blown glass shade available in two sizes and in two colors white and black. Diffuser is duly supported by three adjustable steel cables that attaches to a circular chrome plated metal canopy. Companion wall design also available.



Wall sconce featuring a geometrically patterned blown glass diffuser in white or black. Glass diffuser is supported to a white painted metal structure. Companion two different size pendant designs also available.

DELUXE 35 P

Colors



1 x 150W-R7s (Long)



Certifications

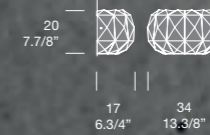

DELUXE

DESIGN / ARCHIRIVOLTO

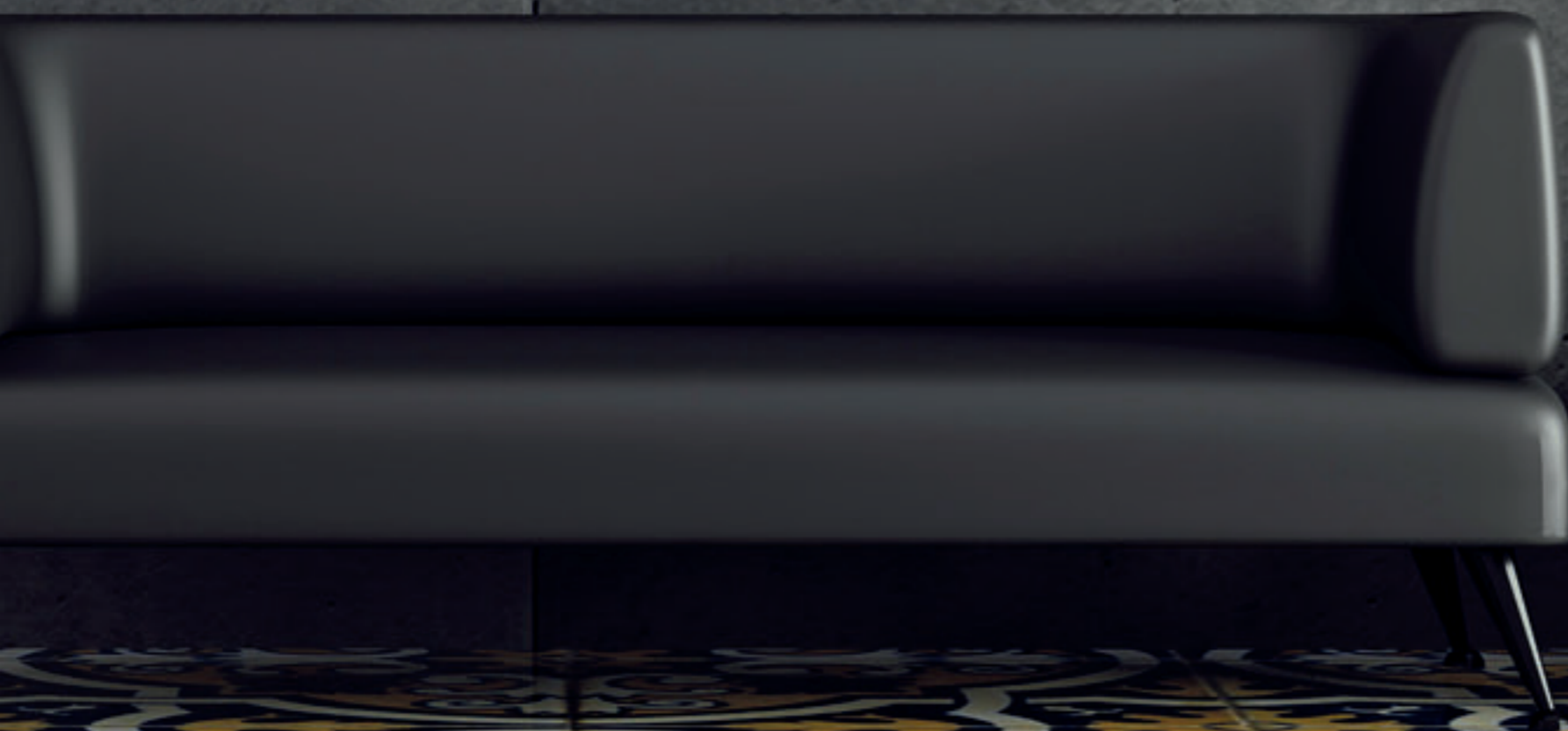

DIANE

DESIGN / ROBERTO PAMIO

Classic wall sconce featuring a tubular, hand blown or slumped glass shade. The incandescent light sources provides diffused, upward, and downward illumination. Companion pendant design also available.



DIANE P (satin white or amber blown glass)

Color

1 x 75W-E26 

Certifications 

DIANE P (satin white slumped glass)

Color

1 x 75W-E26 

1 x 18W-G24q2 

Certifications 





DIANE

DESIGN / ROBERTO PAMIO

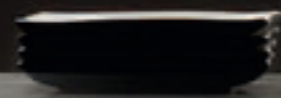

DIANE S (satin white or amber blown glass)

Color

1 x 75W-E26 

Certifications 

DIANE S (satin white slumped glass)

Color

1 x 75W-E26 

Certifications 

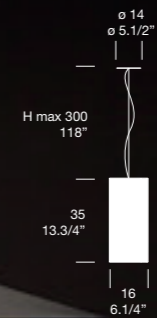

Pendant design highlighted with a hand-blown Murano glass diffuser as well as slumped glass which is cut, and wrapped to reveal the layer of white glass when illuminated by its incandescent light source. Companion wall design also available.



Small-scale pendant with an accordion-shaped, hand-poured, glass diffuser that provides downward and diffused illumination. Two glass options and finishes are offered: crystal and frosted white. Glass diffuser is supported by a clear cord and a polished chrome or brushed nickel metal canopy. Companion recessed design also available.

DISK

DESIGN / TOSO, MASSARI & ASSOCIATES



DISK S

Color



1 x 40W-G9



Certifications



LED OPTION ALSO AVAILABLE.

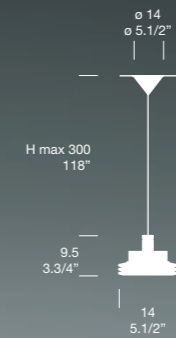

GILL

DESIGN / ROBERTO PAMIO



GILL 40

Colors

● CR

1 x 75-E26



Certifications

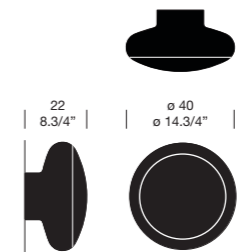

Leucos first design in 1962, Gill is a wall or ceiling mount featuring a round, blown glass diffuser in clear crystal with a circular white detail across the front. Gill is also available with an all satin white glass diffuser.



GLOSSY

DESIGN / MASSIMILIANO ARTUSO

Wall or ceiling design composed of a layered blown glass diffuser available in gloss white. Structure is painted white. Companion pendant design also available.

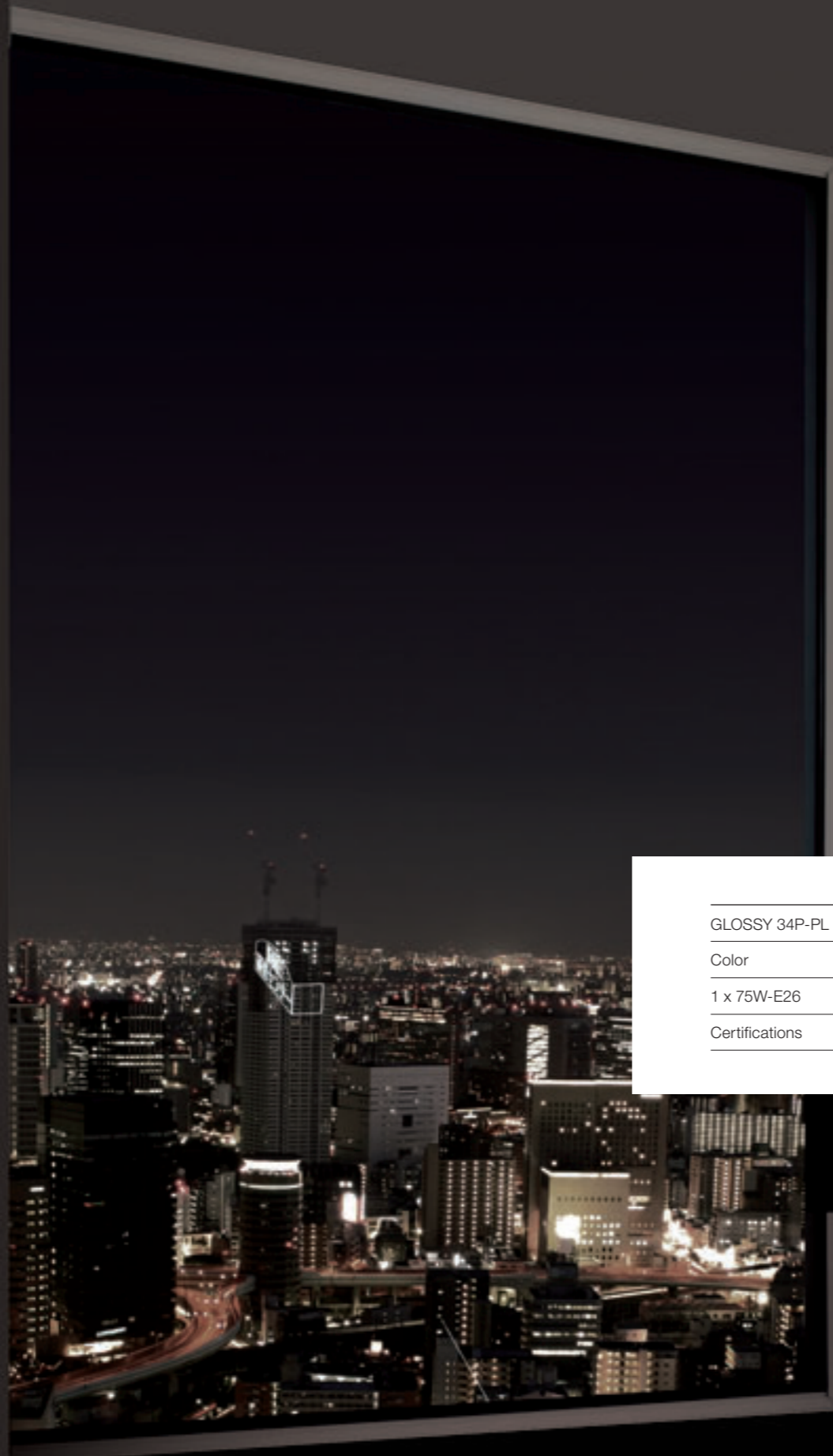

GLOSSY 34P-PL

Color



1 x 75W-E26



Certifications

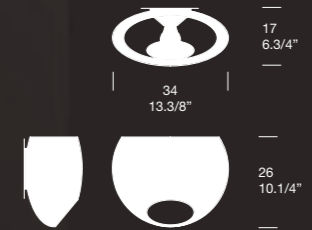



Pendant design composed of a layered blown glass diffuser available in glossy white on white or glossy white on black. Glass diffuser is suspended by steel cable and clear cord to a metal canopy. Companion wall design also available.

GLOSSY S

Colors



1 x 75W E26



Certifications

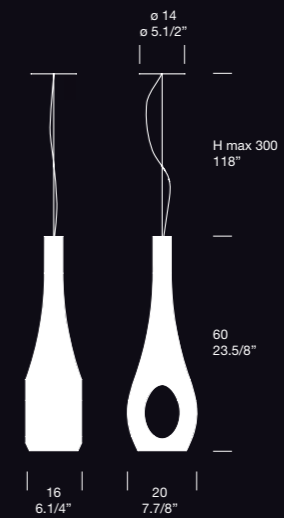

GLOSSY

DESIGN / MASSIMILIANO ARTUSO



GOLF

DESIGN / R. TOSO & N. MASSARI

Globular wall sconce in hand-blown glass providing upward and diffused illumination. Diffuser available in four colors: satin white, satin amber, satin red and mirror finish. Companion ceiling and pendant designs also available.

GOLF P1

Color



1 x 75W E26



1 x 150W E11 mini candelabra



1 x 13W G24q1 quad



Certifications



GOLF P1/SP

Color



1 x 75W E26



1 x 150W E11 mini candelabra



1 x 13W G24q1 quad



Certifications



GOLF P1 - GOLF P1/SP



16
6.1/4"



GOLF PL	
Color	<input type="radio"/> <input type="radio"/>
1 x 75W-E26	
Certifications	
GOLF PL/SP	
Color	<input type="radio"/>
1 x 75W-E26	
Certifications	

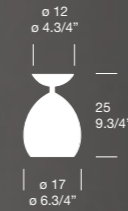

GOLF

DESIGN / R. TOSO & N. MASSARI

Ceiling fixture with hand blown glass diffuser available in a variety of glass colors including; amber, white and mirror finish. The glass diffuser is supported to the arm with metal frame available either in gold or chrome. Companion pendant and wall designs also available.



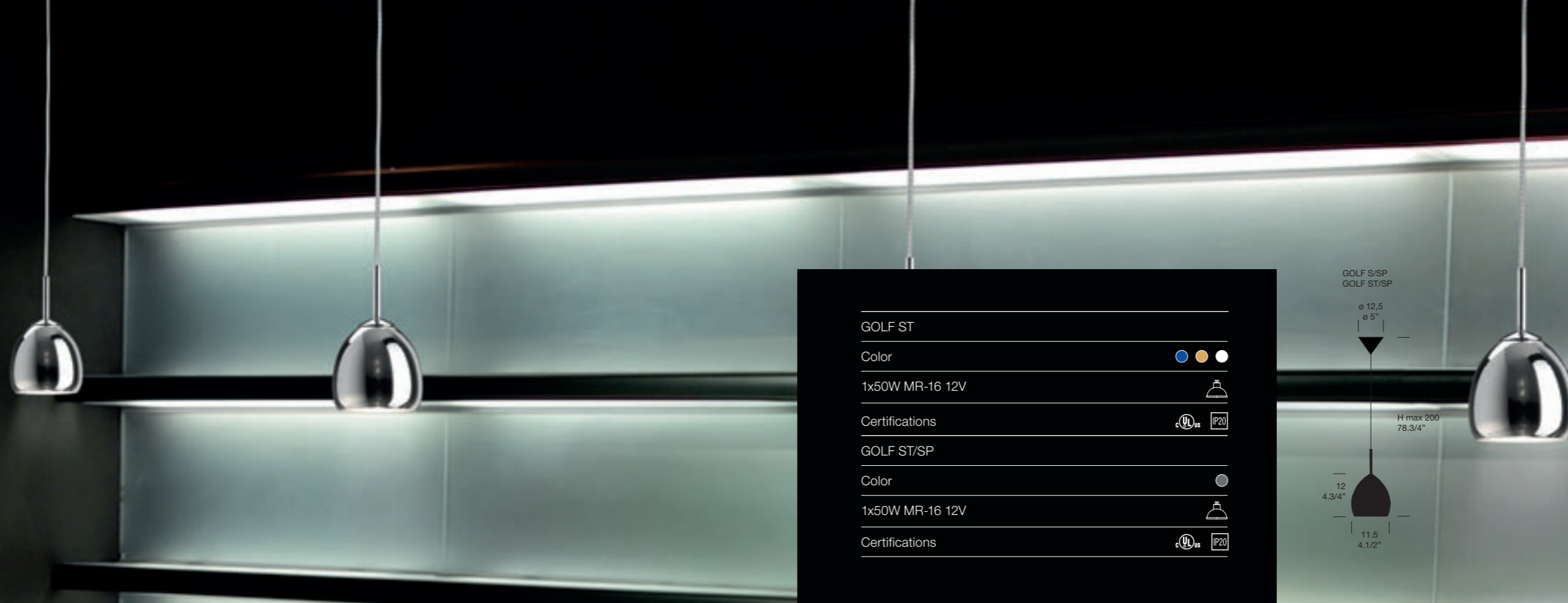

GOLF ST

Color

1x50W MR-16 12V

Certifications

GOLF ST/SP

Color

1x50W MR-16 12V

Certifications

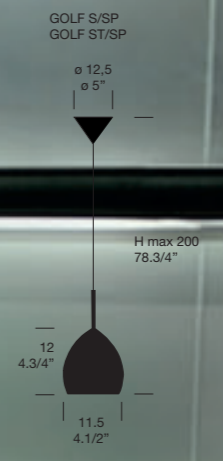

GOLF

DESIGN / R. TOSO & N. MASSARI

Small scale pendant features a hand-blown, softly curved glass diffuser available in satin white, satin amber, satin blue as well as mirror finish. This lo-voltage pendant provides both down-light as well as diffused illumination. Canopy and flexible cord are available in either black or titanium. Companion wall, ceiling and larger scale pendant designs are also available.

Clean -lined suspension design provides down-light and diffused illumination from its hand blown glass diffuser available in satin white, satin amber and mirror glass. The whimsical Golf S2 has a rigid stem in polished chrome or polished gold. The Golf S3 version features a clear cord and polished chrome or gold canopy. Companion wall, ceiling and smaller scale designs also available.

GOLF

DESIGN / R. TOSO & N. MASSARI

GOLF S2

Color



1 x 75W-E26



1 x 18W-G24q2



Certifications



GOLF S2/SP

Color



1 x 75W-E26



1 x 18W-G24q2 quad



Certifications



GOLF S3

Color



1 x 75W-E26



1 x 18W-G24q2



Certifications



GOLF S3/SP

Color



1 x 75W-E26



1 x 18W-G24q2 quad



Certifications



GOLF S2
GOLF S2/SP



3 Length Options:
60 - 23.1/2"
80 - 31.1/2"
130 - 51"

GOLF S3
GOLF S3/SP

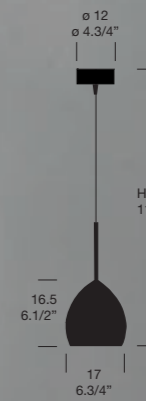

H max 300
118"



JELLYFISH

DESIGN / ROCKWELL GROUP



The Jellyfish Ceiling/Wall Combo creates visual drama with its smooth, voluptuous form and provides a layer of crisp illumination. The Jellyfish 40 Ceiling/Wall Combo features a Clear hand-blown glass shade and metal supports

JELLYFISH 40

Color

2 x 60W-E12

1 x 22W-2GX13-T5C

Certifications

JELLYFISH 50

Color

2 x 75W-E26

1 x 55W-2GX13-T5C

Certifications

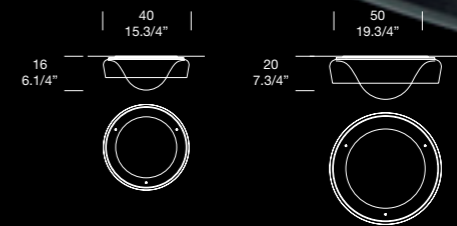

Hand-blown pleated shape glass diffuser sets off this striking pendant. The light source provides downward and diffused illumination. The glass diffuser is supported to a nickel plated brushed metal canopy by steel cable and clear electrical cord adjustable to desired length. Swag mounting options available. Companion wall and table designs also available.



KATERINA
DESIGN / THOMAS SANDELL



KATERINA S50	
Color	<input type="radio"/>
1 x 75W-E26 G40 Globe	
Certifications	
KATERINA S22	
Color	<input type="radio"/>
1 x 60W-E12	
Certifications	

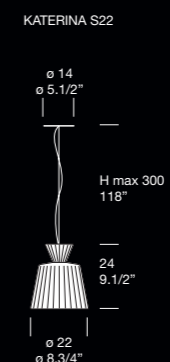
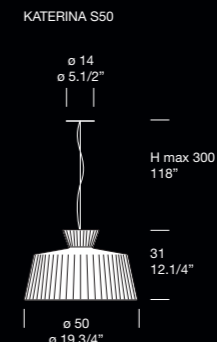

A modern and elegant pendant design, Keyra is available in two sizes with LED illumination. The impressive glass diffuser is hand-blown in clear crystal with white glass at its concave center. Canopy is in white lacquered metal.

KEYRA 30 S

Color CR

LED 1 x 13W 3000 K 900 lm

Certifications  

KEYRA 60 S

Color CR

LED 2 x 13W 3000 K 1800 lm

Certifications  

KEYRA 30 S

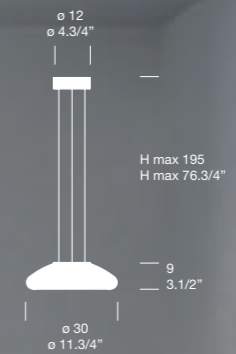

KEYRA 60 S

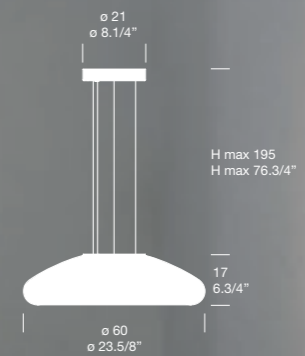

KEYRA

DESIGN / ROBERTO PAOLI



KEYRA

DESIGN / ROBERTO PAOLI

Stylish wall or ceiling design, Keyra is available in two sizes with LED illumination. The impressive glass diffuser is hand-blown in clear crystal with white glass at its concave center. Structure is in white lacquered metal.

KEYRA 30 P-PL

Color CR

LED 1 x 13W 3000 K 900 lm

Certifications  

KEYRA 60 P-PL

Color CR

LED 2 x 13W 3000 K 1800 lm

Certifications  

KEYRA 30 P-PL

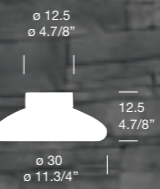

KEYRA 60 P-PL

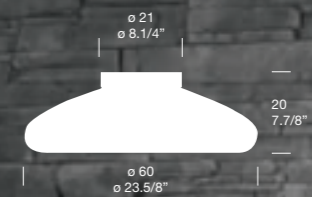

KON

DESIGN / R. TOSO, N. MASSARI & ASSOCIATES



The Kon Collection consists of a small-scale, multi-purpose pendant available with a clear glass diffuser. The incandescent light source provides downward illumination and accents the clarity of the glass and design.

KON

Color

CR

1 x 40W-E12 SPOT R50



Certifications

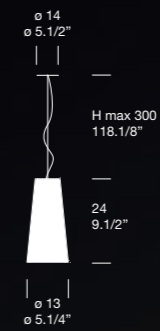



KUBE

DESIGN / MARCO PIVA



KUBE PL

Color

1 x 75W-E26

1 x 18W-G24q2

Certifications

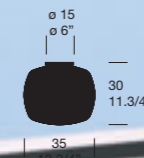

A slightly rounded square mouth blown white glass diffuser is the highlight of this ceiling design providing diffused and general illumination. The glass diffuser is held in place with a brushed nickel metal structure. Companion table and pendant designs also available.

KUBE S

Color



1 x 75W-E26



1 x 18W-G24q2



Certifications

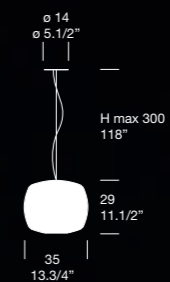

A slightly rounded square mouth blown white glass diffuser is the highlight of this design providing general and diffused illumination. Glass diffuser is secured to a standard junction box with steel cable and clear cord. Optional swag available. Companion table and ceiling design also available.

KUBE

DESIGN / MARCO PIVA



KUK

DESIGN / PAOLO CREPAX



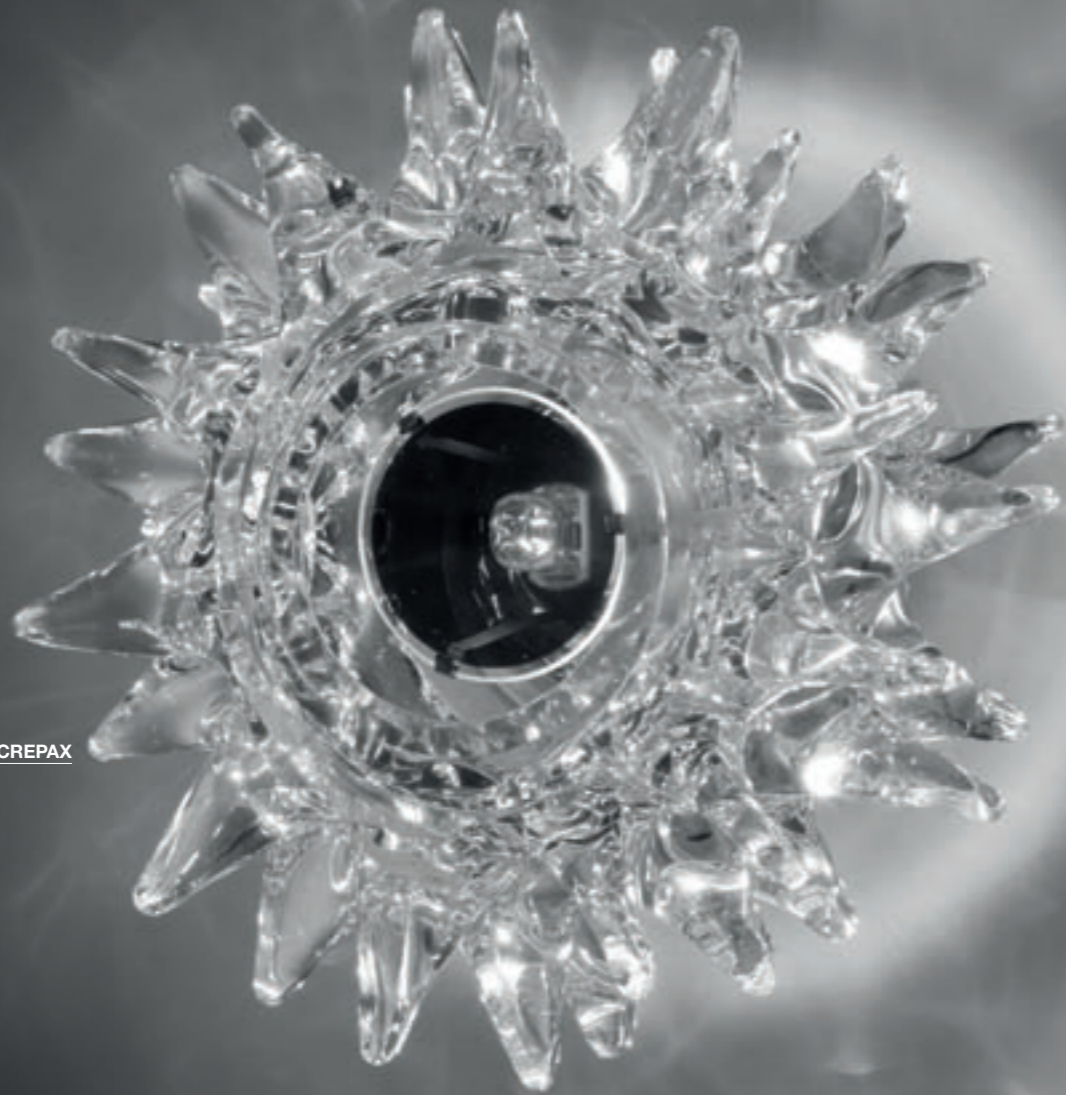

KUK

DESIGN / PAOLO CREPAX

KUK PP

Color

CR

1 x 40W-G9



Certifications



ø 17
ø 6.3/4"



11
4.3/4"

Wall or ceiling design in transparent crystal made with a prestigious, hand-crafted Venetian technique making each one unique. Provided with an anti-glare, silk-screened platinum diffuser. Structure in polished chrome finish.

Small-scale suspension design using a prestigious, hand-crafted Venetian technique that makes each one unique. The glass is transparent crystal and the structure is finished in polished chrome. Swag options are available.

KUK S

DESIGN / PAOLO CREPAX



KUK S

Color

CR

1 x 40W-G9



Certifications

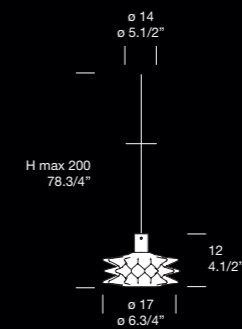

IP ⊕ ⊞ ⊚





LAGUNA

DESIGN / R. TOSO, N. MASSARI & ASSOCIATES WITH G. TOSO

The Laguna wall sconce is a shimmering work of art. It features strategically fractured panels of glass inlaid with colored glass shavings and gold leaf, creating both distinctive artistic effect and flashing play of light. Two square versions and a large rectangular profile are available. Ada compliant.

LAGUNA P74

Colors

2 x 36W 2G11 (Twin)

Certifications   

DIMMABLE BALLAST AVAILABLE UPON REQUEST
LED OPTION ALSO AVAILABLE.

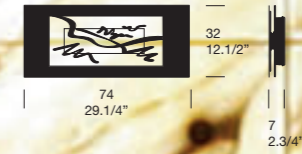

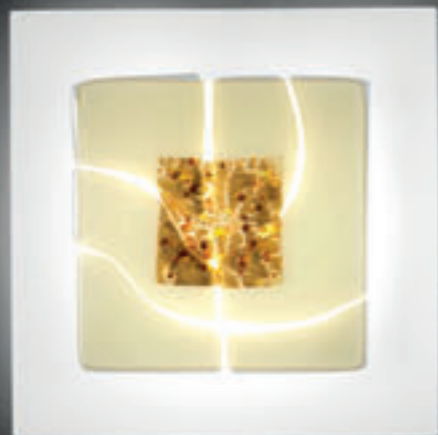

LAGUNA P35 DELTA

Colors

1 x 22W 2GX13

Certifications

LAGUNA P60 DELTA

Colors

1 x 55W 2GX13

Certifications

DIMMABLE BALLAST AVAILABLE UPON REQUEST
LED OPTION ALSO AVAILABLE.

LAGUNA P35 DELTA



LAGUNA P60 DELTA



The Laguna wall sconce is a shimmering work of art. It features strategically fractured panels of glass inlaid with colored glass shavings and gold leaf, creating both distinctive artistic effect and flashing play of light. Two square versions and a large rectangular profile are available. Ada compliant.

LAGUNA

DESIGN / R. TOSO, N. MASSARI & ASSOCIATES WITH G. TOSO



LAGUNA

DESIGN / R. TOSO, N. MASSARI & ASSOCIATES WITH G. TOSO



LAGUNA P35 PLATINUM

Color

1 x 22W-2GX13

Certifications

LAGUNA P74 PLATINUM

Color

2 x 36W-2G11

Certifications

LAGUNA P60 PLATINUM

Color

1 x 55W-2GX13

Certifications

DIMMABLE BALLAST AVAILABLE UPON REQUEST
LED OPTION ALSO AVAILABLE.

LAGUNA P35 PLATINUM

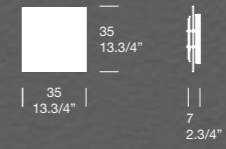

LAGUNA P74 PLATINUM

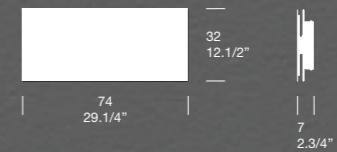

LAGUNA P60 PLATINUM

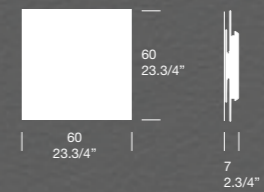

Laguna Platinum is available in square or rectangular profile. This wall sconce features a white glass diffuser at back, accented with a platinum glass element as its focal point. Laguna is ADA compliant.



LAGUNA S75 CANAL	
Colors	<input checked="" type="radio"/> <input type="radio"/>
2 x 24W-G5-T5	
Certifications	
DIMMABLE BALLAST AVAILABLE UPON REQUEST	
LAGUNA S105 CANAL	
Colors	<input checked="" type="radio"/> <input type="radio"/>
2 x 39W-G5-T5	
Certifications	
DIMMABLE BALLAST AVAILABLE UPON REQUEST LED OPTION ALSO AVAILABLE.	

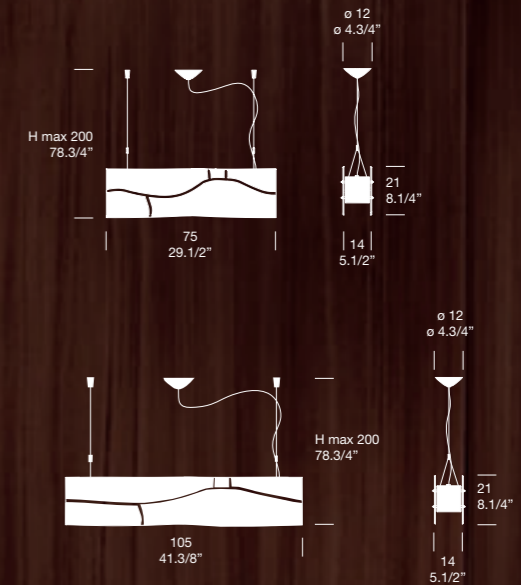

LAGUNA

DESIGN / R. TOSO, N. MASSARI & ASSOCIATES WITH G. TOSO

The Laguna pendant is more than a fixture. It is a work of art. The glass diffuser features a strategically fractured panels of glass inlaid with colored glass shavings and gold leaf, creating both distinctive artistic effect and flashing play of light. The fixture body is suspended by the chrome structure by two steel cables.



LAGUNA

DESIGN / R. TOSO, N. MASSARI & ASSOCIATES WITH G. TOSO

The Laguna pendant Platinum, available in two sizes, features two white glass diffusers decorated with a striking platinum designs with black lines. The fixture body is suspended by the chrome structure by two steel cables.

Dimmable version available upon request.

LAGUNA S105 PLATINUM

Color

2 x 39W-G5-T5 

Certifications  

DIMMABLE BALLAST AVAILABLE UPON REQUEST

LAGUNA S75 PLATINUM

Color

2 x 24W-G5-T5 

Certifications  

DIMMABLE BALLAST AVAILABLE UPON REQUEST
LED OPTION ALSO AVAILABLE.

LAGUNA S105 PLATINO



LAGUNA S75 PLATINO

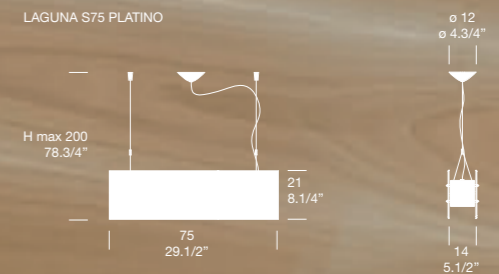

LINK

DESIGN / MAURO MARZOLLO

LINK P

Colors



1 x 100W R7s (Long)



Certifications

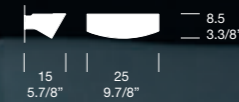
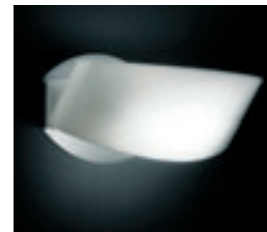

Wall sconce featuring elegant satin finish blown glass diffuser available in white, red or black. Metal structure in brushed nickel supports the glass diffuser.



LOOP

DESIGN / R. TOSO, N. MASSARI & ASSOCIATES

Artfully abstract ceiling design provides diffused illumination from a tiered blown white glass diffuser that is offset and enclosed. Concealed white metal structure secures the glass diffuser to a standard junction box. Companion ceiling design also available.

LOOP PL

Color



1 x 75-E26



2 x 18W-G24q2



Certifications

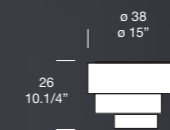



LOOP-LINE

DESIGN / R.TOSO, N. MASSARI & ASSOCIATES WITH G. TOSO



















LOOP-LINE

DESIGN / R.TOSO, N. MASSARI & ASSOCIATES WITH G. TOSO

Wall/ceiling design composed of a satin white, hand-blown glass diffuser consisting of concentric circles. Concealed white metal structure secures the glass diffuser to a standard junction box. Companion ceiling design also available.

LOOP-LINE	
Color	○
1 x 55W-T5-2GX13	○
Certifications	  
LED 45W 3000K 5400lm	
Certifications	 
LOOP-LINE 32	
Color	○
LED 15W 3000K 1800lm	
Certifications	   
2 x 40W E26	
Certifications	   
LED OPTION ALSO AVAILABLE.	

LOOP-LINE

16
6.1/4"



ø 60
ø 23.5/8"

LOOP-LINE 32

10
4"



ø 32
ø 12.5/8"

MANHATTAN

DESIGN / **DANILO DE ROSSI**

A series of architectural multi-dimensional wall sconces providing general illumination. Available in 3 versions and two light sources: fluorescent and incandescent. The metal frame is brushed nickel with polished chrome details.





MANHATTAN

DESIGN / **DANILO DE ROSSI**

MANHATTAN P53

Color

2 x 36W-2G11 

Certifications   

MANHATTAN P

Color

1 x 75W-E26 

1 x 24W-2G11 

Certifications  

MANHATTAN P24

Color

1 x 75W-E26 

2 x 26W-G24q3 

Certifications   

MANHATTAN P53

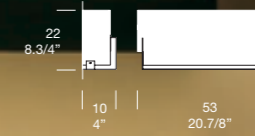

MANHATTAN P



MANHATTAN P24





MERCURE S	
Color	●
1 x 60W - E12 (Clear)	💡
Certifications	UL IP20

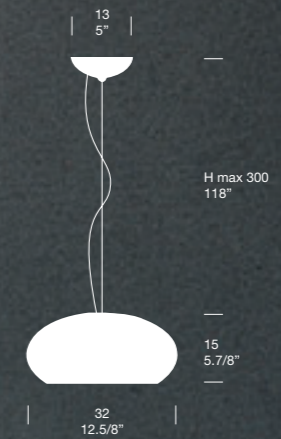

MERCURE

DESIGN / PATRICK JOUIN

The glass diffuser of this unique pendant fixture is made of countless bubbles. A classic “pulegoso” piece designed by the renewed designer Patrick Jouin. Structure is polished chrome





MERCURE

DESIGN / PATRICK JOUIN

MERCURE P-PL

Color

3 x 40W - E12 (Clear)

Certifications

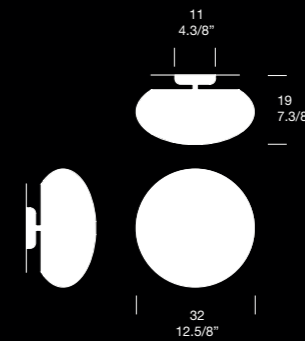

The glass diffuser of this unique wall or ceiling fixture is made of countless bubbles. A classic “pulegoso” piece designed by the renewed designer: Patrick Jouin. Structure is polished chrome.



MICENE S

Color

1 x 250W-E26 (Halostar) 

Certifications 

MICENE S38

Color

1 x 75W-E26 

1 x 18W-G24q2 

Certifications 

MICENE S25

Color

1 x 75W-E26 

Certifications 

MICENE S

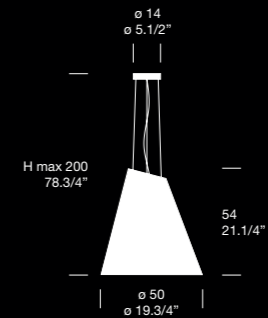

MICENE S38

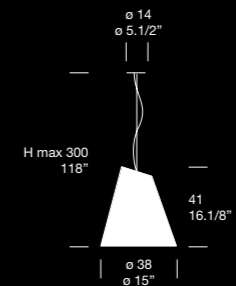

MICENE S25

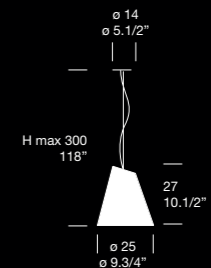

Pendant fixture providing direct downward and diffused ambient light through its hand-blown conical glass diffuser available in both satin white or satin amber. The glass diffuser is connected to a metal canopy by steel cable and black cord adjustable to desired length. Companion wall and large table designs also available.

MICENE

DESIGN / R. TOSO, N. MASSARI & ASSOCIATES



MILD PP	
Color	<input checked="" type="checkbox"/>
1 x 75W-E26	
2 x 18W-G24q2	
Certifications	

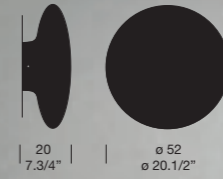

MILD

DESIGN / JORGE PENSI

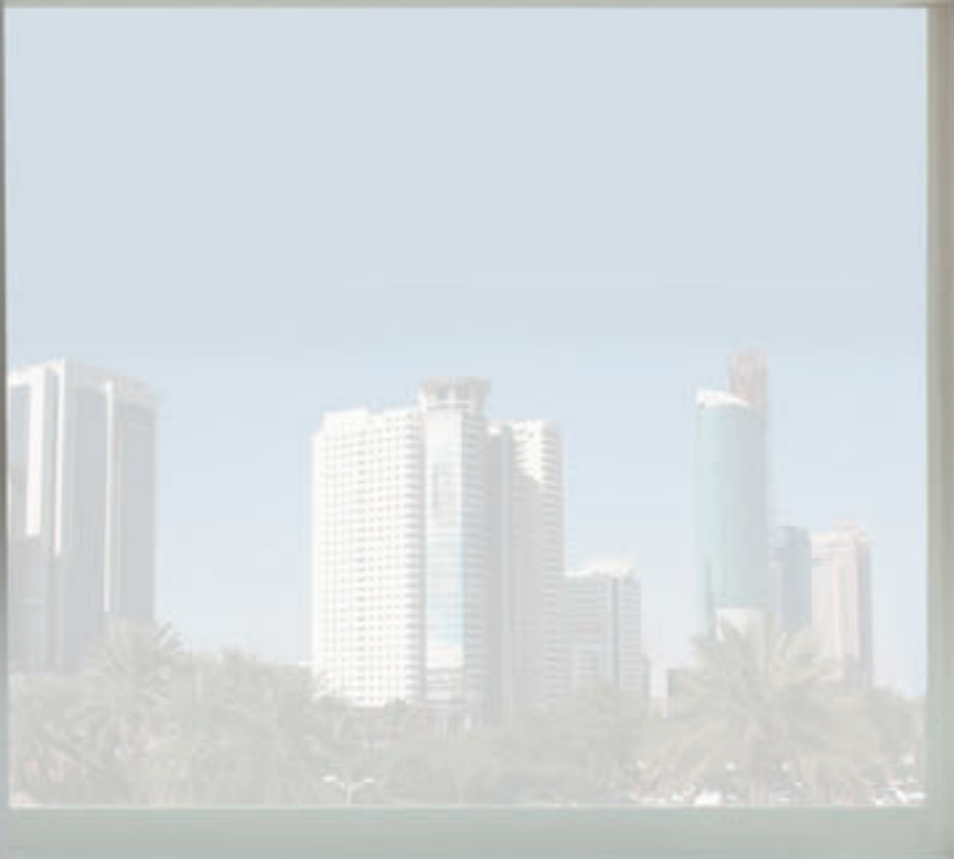

A large-scale, satin white blown-glass diffuser that appears to float off the ceiling or wall highlights this simple design. Compact fluorescent or incandescent light sources are available and all provide diffused illumination. A companion pendant is also available.

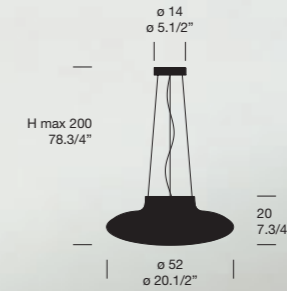
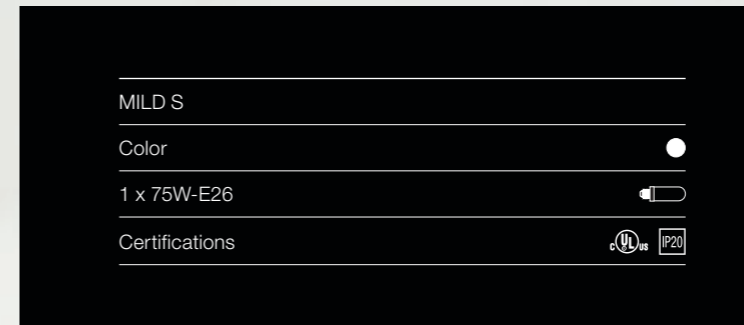

A large suspension lamp which appears to float from its cable and cord suspension. Handblown, satin white glass is illuminated by an incandescent light source to provide diffused and upward illumination. A companion wall/ceiling design is available.

MILD S

DESIGN / JORGE PENSI

MODULO

DESIGN / R. TOSO, N. MASSARI & ASSOCIATES



MODULO P/CL

Color	<input type="radio"/>
1 x 75W-E26	
2 x 13W-G24q1	
2 x 18W-G24q2	
2 x 26W-G24q3	
Certifications	

MODULO P22

Color	<input type="radio"/>
1 x 75W-E26	
2 x 13W-G24q1	
2 x 18W-G24q2	
Certifications	

MODULO P35

Color	<input type="radio"/>
1 x 75W-E26	
2 x 13W-G24q1	
2 x 18W-G24q2	
2 x 26W-G24q3	
Certifications	

MODULO PL35

Color	<input type="radio"/>
1 x 75W-E26	
1 x 18W-G24q2	
Certifications	

LED OPTION ALSO AVAILABLE.

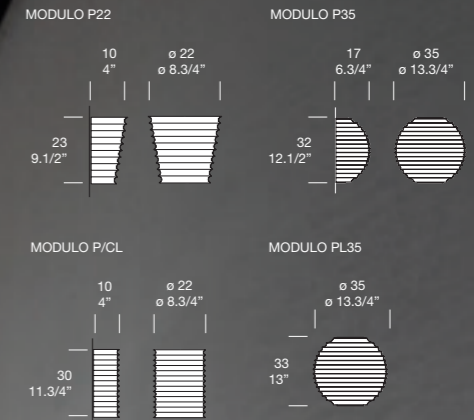

A hand-blown, ribbed glass diffuser provides diffused illumination and a burst of uplight through the glass diffuser in addition to soft downlight. Clear outer bands of glass are highlighted by the incandescent or fluorescent lightings options. Glass diffuser is held in place with metal structure available in brushed nickel. Companion wall, pendant, ceiling and table designs also available.



MODULO

DESIGN / R. TOSO, N. MASSARI & ASSOCIATES

Pendant design with a ribbed blown glass diffuser with crystal accent edges available as round, cylindrical and conical shape. Metal structure available in brushed nickel finish. Companion wall designs in various sizes also available.

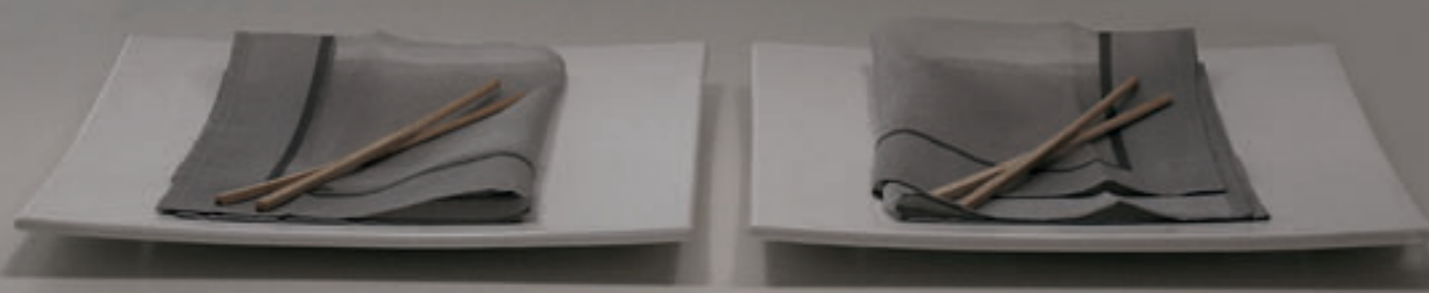

MODULO S22

Color 

1 x 75W-E26 

Certifications 

MODULO S22/CL - S35

Color 

1 x 75W-E26 

1 x 18W-G24q2 

Certifications 

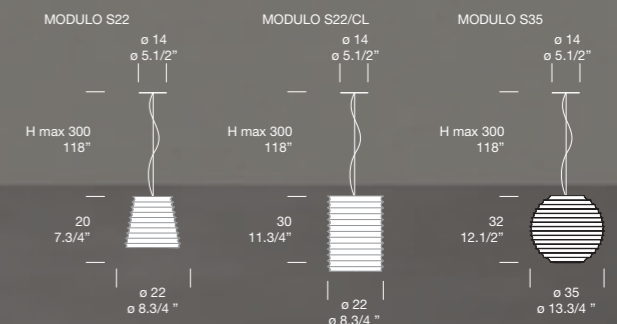

NUBIA

DESIGN / R. TOSO, N. MASSARI & ASSOCIATES

A round, scalloped hand blown glass diffuser, available in 2 sizes and 3 unique glass colors: satin white, satin amber and amber zebra highlights this design. Resembling clouds or shells, the designs are suitable for wall or ceiling applications. Companion pendant, wall and ceiling designs are available.

NUBIA PP 60	
Color	
3 x 60W-E26	
3 x 26W-G24q3	
Certifications	
NUBIA PP 45	
Color	
3 x 40W-E12	
2 x 18W-G24q2	
Certifications	

NUBIA PP 60

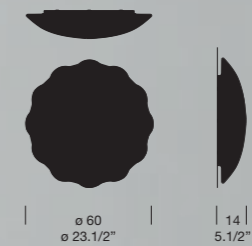

NUBIA PP 45

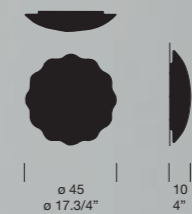



NUBIA

DESIGN / R. TOSO, N. MASSARI & ASSOCIATES

NUBIA S2/45

Color



1 x 200W-R7s (Long)



Certifications

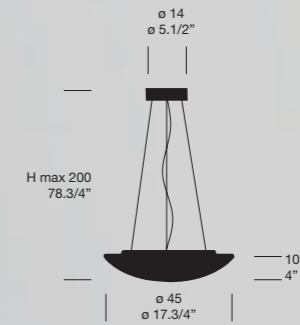

Simple and elegant pendant fixture consists of a dome-shaped, satin white or satin amber and amber zebra blown glass diffuser with fluted edges. Glass diffuser is suspended from the brushed nickel canopy with three steel cables and clear cord. Companion wall/ceiling designs are also available.



This small scale pendant features a hand-poured glass diffuser that provides both downward as well as diffused illumination. Two glass options and finishes are offered: crystal and frosted white. Glass diffuser is supported by a clear cord and a polished chrome or brushed nickel metal canopy. Companion recessed design also available.

ONY

Colors



1 x 40W-G9



Certifications



LED OPTION ALSO AVAILABLE.

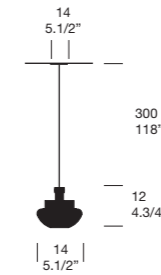

ONY

DESIGN / R. TOSO, N. MASSARI & ASSOCIATES





PLANET

DESIGN / LEUCOS DESIGN TEAM

Wall and ceiling design featuring a serigraphed white glass diffuser with a translucent edge. The structure is white painted metal with a flared edge and a polished chrome detail. Fluorescent or halogen light source available (PLANET 48-65) e LED (PLANET 32).

PLANET

DESIGN / LEUCOS DESIGN TEAM

Wall and ceiling design featuring a serigraphed white glass diffuser with a translucent edge. The structure is white painted metal with a flared edge and a polished chrome detail. Fluorescent or incandescent light source available (PLANET 48-65) and LED (PLANET 32).

PLANET 48

Color

6 x 25W-G9 

1 x 40W-2GX13-T5C

Certifications   

PLANET 32

Color

LED 10W 3000K 1350lm

Certifications   

PLANET 48



PLANET 32

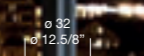



PLANET

DESIGN / LEUCOS DESIGN TEAM

PLANET 65

Color



6 x 25W-G9



1 x 55W-2GX13-T5C



Certifications



DIMMABLE BALLAST AVAILABLE UPON REQUEST

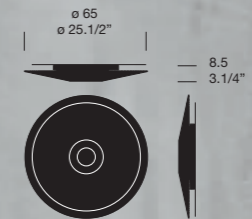

Wall and ceiling design featuring a serigraphed white glass diffuser with a translucent edge. Available in three sizes. The structure is white painted metal with a flared edge and a polished chrome detail. Fluorescent or incandescent light source available.

SAIL

DESIGN / CARLA BARATELLI

Architectural wall sconce available in satin white glass with a painted titanium frame. Available in two sizes both of which are ADA compliant.

SAIL 40

Color

2 x 24W 2G11 Twin

Certifications

SAIL 63

Color

2 x 55W 2G11 Twin

Certifications





SELIS

DESIGN / R. TOSO & N. MASSARI





SELIS PP 30 (blown glass)
 SELIS PP 35 (blown glass)
 SELIS PP 45 (blown glass)

Color ● ●

SELIS PP 30/T (slumped glass)
 SELIS PP 35/T (slumped glass)
 SELIS PP 45/T (slumped glass)

Color ●

SELIS PP 30/TH (slumped with clear edge)
 SELIS PP 35/TH (slumped with clear edge)
 SELIS PP 45/TH (slumped with clear edge)

Color ●

1 x 200W-R7s (Long) ⚡

1 x 75W-E26 💡

2 x 13W-2GX7 Twin 💡

2 x 18W-2G11 Twin 💡

Certifications (PP 30) UL P20 ADA

Certifications (PP 35/PP45) UL P20

SELIS PP45

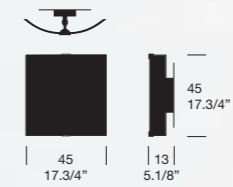

SELIS PP35

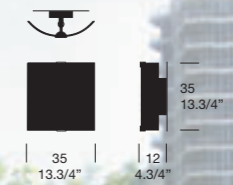

SELIS PP30

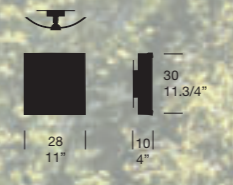

SELIS

DESIGN / R. TOSO & N. MASSARI

Wall or ceiling fixture providing diffused ambient light as well as, a soft glow through its curved hand-blown layered Murano glass diffuser in satin white and satin amber. Available in three sizes, three type of glass and three light sources. Polished chrome metal mounting brackets support the glass diffuser.





This striking pendant light consists of a clear glass cylinder filled with crushed ruby red or white glass accented with decorative clear cord.

SHAKER S

Colors



1 x 35W GU4



Certifications

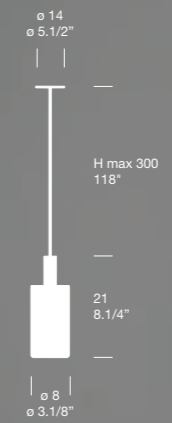

SHAKER

DESIGN / DAA





This unique and creative floor lamp consists of a clear glass cylinder filled with crushed ruby or white glass. The TR1 design has a concrete base with handle which evokes the image of a block of ice with a pick in it which visually ties the crushed glass detail at the top. The TR design features a simple, square base. Dimmer provided on cord.

SHAKER TR - SHAKER TR1

Colors



1 x 35W GU4 + Dimmer



Certifications



SHAKER TR1



SHAKER TR



SHAKER

DESIGN / DAA







SPHERA

DESIGN / MATTEO THUN

SPHERA PP37

Color 

1 x 75W-E26 

1 x 18W-G24q2 

Certifications  

SPHERA PP29

Color 

1 x 60W-E26 

1 x 18W-G24q2 

Certifications  

SPHERA PP37

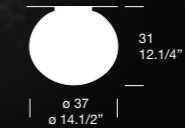

SPHERA PP29

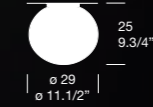

Ceiling and wall mounted fixture emphasizes a strikingly simple design that is highlighted by a hand-blown satin white glass sphere that rests against the ceiling or wall, The Sphera Collection wonderfully combines simple style with modern design. Companion pendant, table designs also available.

SPHERA

DESIGN / MATTEO THUN

Small scale Wall / Ceiling fixture emphasizes a strikingly simple design that is highlighted by a hand-blown satin white glass sphere that lies flush against wall or ceiling. Companion pendant, ceiling, table designs also available.

SPHERA PP 20

Color



1 x 40W-E12



Certifications





A slightly flattened oval highlights this simple glass design that floats off the ceiling and provides diffused illumination from its incandescent light source. Companion table, floor, ceiling and wall design also available.

SPHERA

DESIGN / MATTEO THUN

SPHERA S45

Color

1 x 75W E26 

1 x 18W-G24q2 

Certifications    

SPHERA S37

Color

1 x 75W-E26 

1 x 18W-G24q2 

Certifications    

SPHERA S29

Color

1 x 75W-E26 

1 x 18W-G24q2 

Certifications    

SPHERA S20

Color

1 x 60W-E12 

Certifications  

SPHERA S45

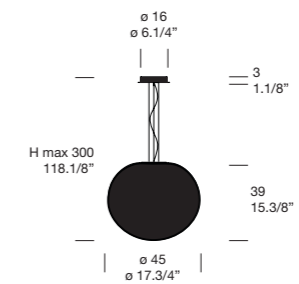

SPHERA S37

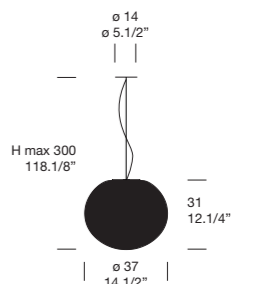

SPHERA S29

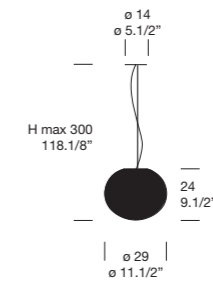



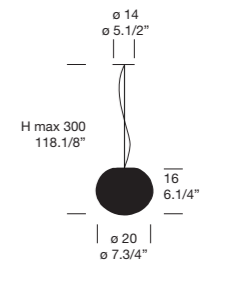



SPHERA S20



Accent table lamp emphasizes a striking simple design that is highlighted by a hand-blown, satin white glass sphere that sits on a small polished chrome base. Companion wall, pendant, ceiling designs also available.

SPHERA

DESIGN / MATTEO THUN

SPHERA T3/20	
Color	<input type="radio"/>
1 x 60W-E12	
Certifications	 
SPHERA T3/29	
Color	<input type="radio"/>
1 x 60W-E26	
Certifications	 
SPHERA T3/37	
Color	<input type="radio"/>
1 x 75W-E26	
Certifications	 
SPHERA T3/45	
Color	<input type="radio"/>
1 x 75W-E26	
Certifications	  

SPHERA T3/20

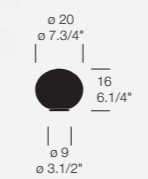

SPHERA T3/29

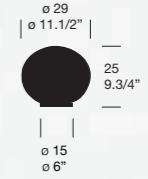

SPHERA T3/37

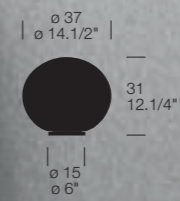

SPHERA T3/45

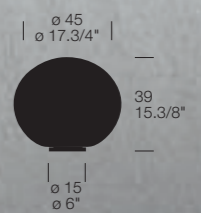

SPORE

DESIGN / IOSA GHINI



SPORE S

Color

CR

LED 8 x 3W - 3500 K 1600 lm

Certifications

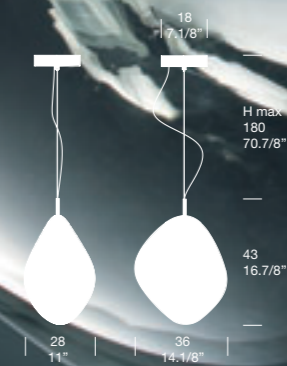

The Spore is a unique and creative pendant. It consists of a pebble-shaped, transparent crystal blown glass diffuser, suspended from the chrome-plated base in the ceiling. The eight LED lamps hang inside the diffuser at various heights.

GOOD DESIGN AWARD
The Chicago Athenaeum 2009

IAI AWARDS 2011

ADI DESIGN INDEX

SPRING

DESIGN / EVA ZEISEL



SPRING T

Color	
1 x 75W-E26	
1 x 18W-GU24	
Certifications	

SPRING S

Color	
1 x 75W-E26	
1 x 18W-GU24	
1 x 18W-G24q2	
Certifications	

SPRING P

Color	
1 x 75W-E26	
1 x 18W-GU24	
1 x 18W-G24q2	
Certifications	

SPRING T

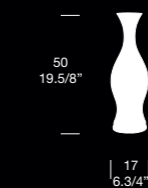

SPRING S

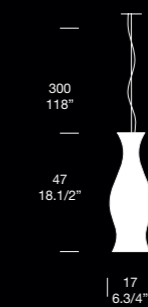

SPRING P

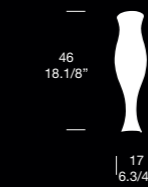

The Spring series by Eva Zeisel is characterized by soft curves and fluid lines. Composed of mouth-blown Venetian glass, the svelte shape of Spring comes in several models including pendant, wall sconce and table. Most unusual is the shade-less table lamp, which emits ambient light and resembles a glowing sculpture. It is accented with polished chrome at its base. The color palette for Zeisel's creations reflects the natural aesthetic of the lights. Spring is offered in glossy white, as well as warm honey.



STACKING A



STACKING B



STACKING D

STACKING A	
Color	
4 x 35W-GU10 + dimmer	
Certifications	
STACKING B	
Color	
4 x 35W-GU10 + dimmer	
Certifications	
STACKING D	
Color	
4 x 35W-GU10 + dimmer	
Certifications	

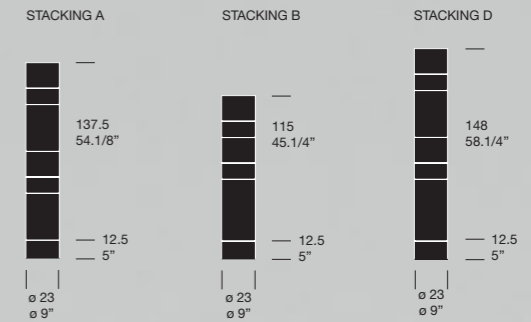

Floor lamp composed of assembled blown glass cylinders in distinct colorways and sizes. Metal base available in polished chrome or polished gold.

STACKING A: white, orange, crystal, white, orange, polished mirror. Base finish: polished chrome.

STACKING B: smoked, white, smoked, white, polished mirror. Base finish: polished chrome.

STACKING D: white, gold mirror, tobacco, white, gold mirror, black/white Inside. Base finish: polished gold.

STACKING

DESIGN / ROCKWELL GROUP

STACKING

DESIGN / ROCKWELL GROUP



STACKING C

STACKING C

Color



4 x 35W-GU10 + dimmer



Certifications

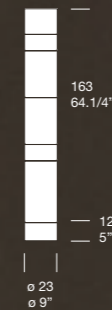

Floor lamp composed of individual blown glass cylinders in distinct color combinations and sizes. Halogen light sources in the base provide the up light to the luminous column of glass. Metal base available in polished chrome or polished gold.
 STACKING C: Color composition: smoked, white, amber, tobacco, white, tobacco/white inside. Base finish: polished gold.

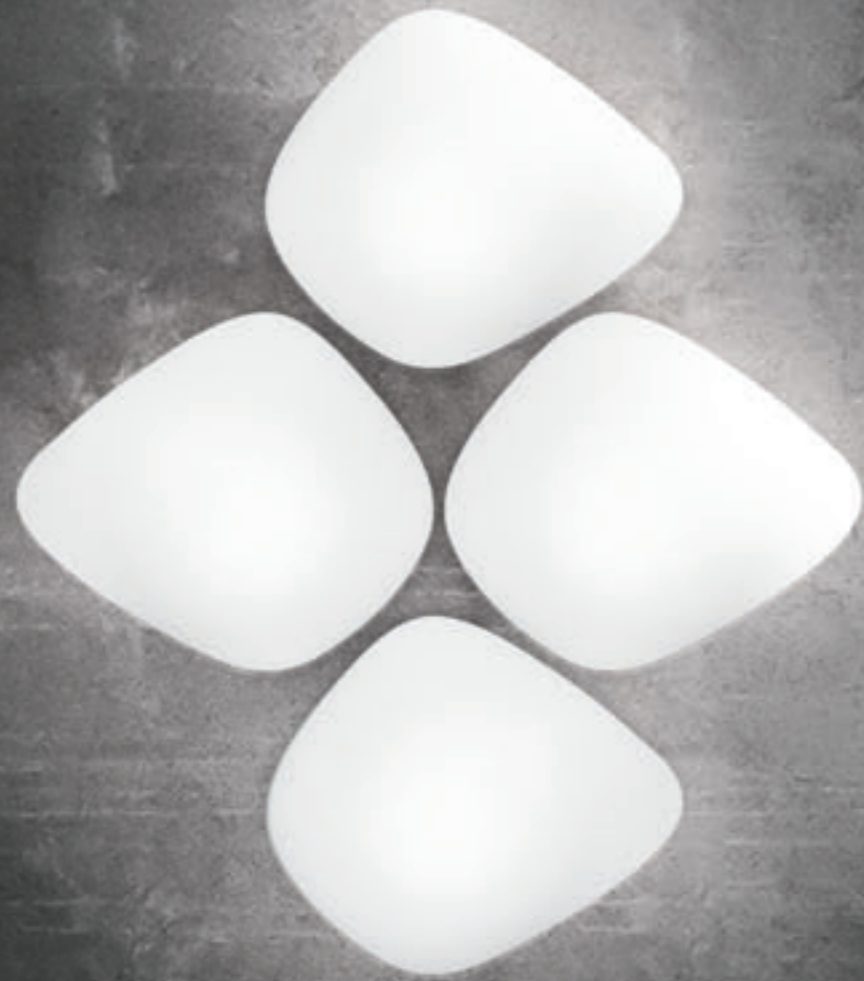

STONE	
Color	<input type="radio"/>
2 x 60W E26	
Certifications	

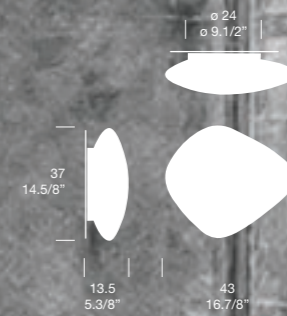

STONE

DESIGN / UFFICIO STILE

A stone like shape wall/ceiling fixture providing total diffusion of light through its hand blown white glass diffuser. A white lacquered back plate secures the glass diffuser to the structure.



SUMMER

DESIGN / EVA ZEISEL



SUMMER T	
Color	
1 x 75W-E26	
1 x 18W-GU24	
Certifications	
SUMMER S	
Color	
1 x 75W-E26	
1 x 18W-GU24	
1 x 18W-G24q2	
Certifications	
SUMMER P	
Color	
1 x 75W-E26	
1 x 18W-GU24	
1 x 18W-G24q2	
Certifications	

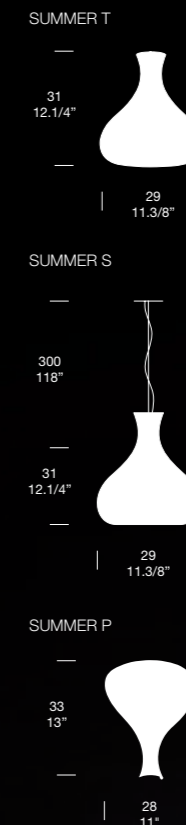

The Summer series designed by world renowned ceramics artist, Eva Zeisel, is a sculptural element as well as a source of illumination. Formed from mouth-blown Venetian glass, the Summer family is composed of pendant, table and wall designs. The pendant model has a slightly rounded indentation at the bottom, while the table light's base is flat and accented by polished chrome. The curvaceous glass diffuser is available in glossy white or warm honey.



TODD

DESIGN / JORGE PENSI

Ribbed white glass highlights this clean-lined, large scale wall sconce that provides general illumination. The glass diffuser is held in place to the structure with two polished chrome details.

TODD

Color



4 x 40W-G9



1 x 36W-2G11 (Twin)



Certifications

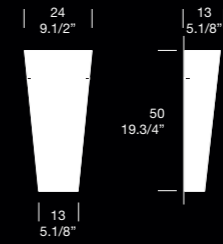

Table lamp providing upward, downward and diffused illumination from its halogen light source. Hand-blown glass diffuser available in: satin white, satin amber (T1) and crystal (T1/C). Companion wall, pendant and floor designs also available.

VITTORIA T1

Color 

1 x 200W- R7s (long) + dimmer 

Certifications 

VITTORIA T1/C

Color  CR

1 x 200W- R7s (long) + dimmer 

Certifications 

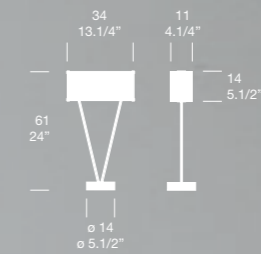

VITTORIA

DESIGN / R. TOSO, N. MASSARI & ASSOCIATES





VITTORIA S2

Color  

1 x 200W-R7s (Long) 

Certifications  

VITTORIA S2 C

Color CR

1 x 200W-R7s (Long) 

Certifications  

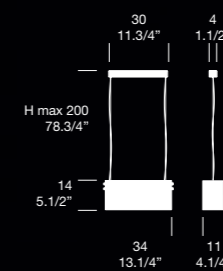

VITTORIA

DESIGN / R. TOSO, N. MASSARI & ASSOCIATES



On oval shaped hand blown glass diffuser floats on two steel cables to provide downward, upward and diffused illuminations from a halogen light source. The glass shade is available in satin white, satin amber and crystal. Perforated anti-glare screen metal diffuser provided for glare reduction with the crystal glass. Companion table, wall and floor designs also available.





VITTORIA

DESIGN / R. TOSO, N. MASSARI & ASSOCIATES

VITTORIA P2

Color



1 x 150W-R7s (Short)



2 x 18W-G24q2



Certifications

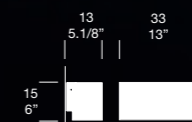

Oval shaped glass diffuser providing upward, downward and diffused illumination. Glass diffuser available in satin white, satin amber and crystal. White enamel back plate supports the glass diffuser with two polished chrome details. Companion table, wall, pendant and floor designs available.



VITTORIA

DESIGN / R. TOSO, N. MASSARI & ASSOCIATES



VITTORIA P2/C

Color

CR

1x150W-R7s (Short)



Certifications

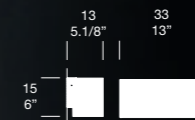

Oval shaped crystal glass diffuser provides up, down and diffused illumination from a halogen light source. Perforated anti-glare screen provided with the crystal glass. A rectangular back-plate finished in polished chrome supports the clear glass diffuser. Companion table, wall, pendant and floor designs available.

VITTORIA

DESIGN / R. TOSO, N. MASSARI & ASSOCIATES



VITTORIA TR1

Color

1 x 200W-R7s (Long) + dimmer

Certifications IP20

VITTORIA TR1/C

Color CR

1 x 200W-R7s (Long) + dimmer

Certifications IP20

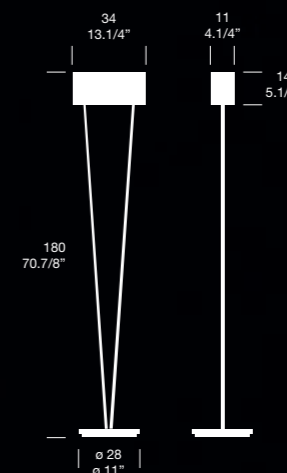

A re-styled version of classic Vittoria. The base and stem of the floor lamp have been redesigned, yet the clean lined, oval glass diffuser remains the highlight of the series. The glass shade is available in satin white, satin amber and crystal. Perforated anti-glare screen metal diffuser provided for glare reduction with the crystal glass. Companion wall, table and suspension versions also available. Dimmer provided on cord.



Large scale, striking table lamp with black glass base embedded with 24K gold leaf. The large top diffuser is available in 3 unique glass colors: satin amber, satin white or amber spotted. The black base, which is weighted to support the large mouth blown glass diffuser. On/off switch is provided on the black cord. Companion pendant and wall designs also available.

VIVIA T	
Color	<input type="radio"/> <input type="radio"/> <input type="radio"/>
1 x 75W-E26	<input type="checkbox"/>
Certifications	<input type="checkbox"/> IP20

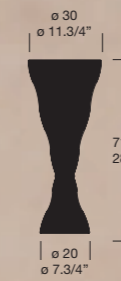

VIVIA

DESIGN / R. TOSO, N. MASSARI & ASSOCIATES

VIVIA

DESIGN / R. TOSO, N. MASSARI & ASSOCIATES

A unique hand blown glass diffuser characterizes this wall sconce. Available in three glass finishes: satin white, satin amber or amber spotted and two light sources. The white metal structure supports and secures the glass diffuser with two polished chrome or polished chrome details. Companion pendant and table designs also available.

VIVIA P	
Colors	
1 x 75W-E26	
2 x 13W-2Gx7 (Twin)	
Certifications	
VIVIA P19	
Colors	
1 x 60W-E12	
1 x 13W-2Gx7 (Twin)	
Certifications	

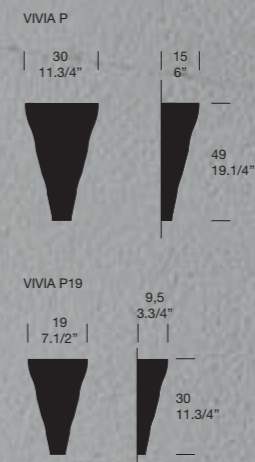



VIVIA S30	
Colors	
1 x 75W-E26	
Certifications	
VIVIA S19	
Colors	
1 x 75W-E26	
Certifications	

A graceful, cone-shaped pendant features a mouth blown glass diffuser in two sizes and three glass finishes: satin white, satin amber or amber spotted. The glass diffuser is supported to the metal structure by adjustable steel cable and clear cord. A swag option is also available to offset or for multiple applications. Companion wall and table designs also available.

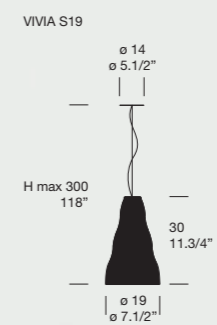
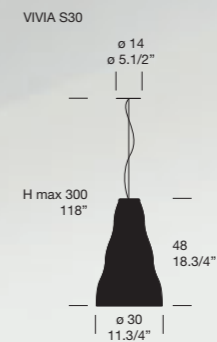

VIVIA

DESIGN / R. TOSO, N. MASSARI & ASSOCIATES

WIMPY

DESIGN / R. TOSO, N. MASSARI & ASSOCIATES WITH G. TOSO

WIMPY PP16

Color

1 x 40W G9

Certifications

LED 6,4W 3000K 500lm

Certifications

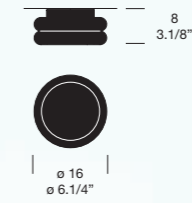
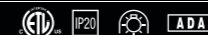
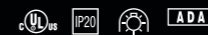

The Wimpy wall/ceiling fixture is graceful and simple. An anodized aluminum frame on the ceiling supports the LED lamp inside a round glass diffuser with a white satin finish.



The Wimpy wall/ceiling fixture is graceful and simple. An anodized aluminum frame on the ceiling supports the LED lamp inside a round glass diffuser with a white satin finish.

WIMPY PP32

Color

LED 15W 3000K 1800lm

Certifications

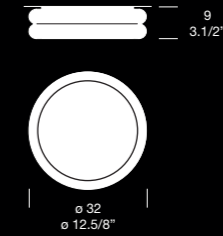

WIMPY

DESIGN / R. TOSO, N. MASSARI & ASSOCIATES WITH G. TOSO

The Wimpy table lamp is simple yet radiant and unique. Mounted on a circular, anodized aluminum base on the table is the single lamp inside a round glass diffuser with a white satin finish.

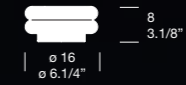

WIMPY T16	
Color	<input type="radio"/>
LED 6,4W 3000K 500lm	
1 x 40W G9	<input type="checkbox"/>
Certifications	<input type="checkbox"/> <input type="checkbox"/>

WIMPY

DESIGN / R. TOSO, N. MASSARI & ASSOCIATES WITH G. TOSO





This blown glass suspension light has an enchanting quality, as its incandescent light source glows expressively through its center. Designed by Marco Piva, it is available in four color palettes: transparent black with black painted metal structure; mirrored crystal on chrome plated metal structure; white on chrome plated metal structure; or gray on chrome plated metal structure.

WITCH

Colors



1 x 150W-E26 (Halostar)



Certifications

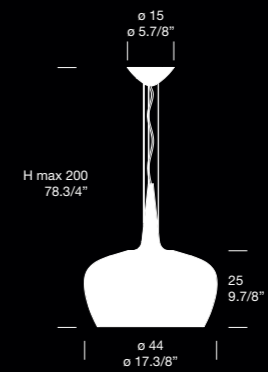

WITCH

DESIGN / MARCO PIVA





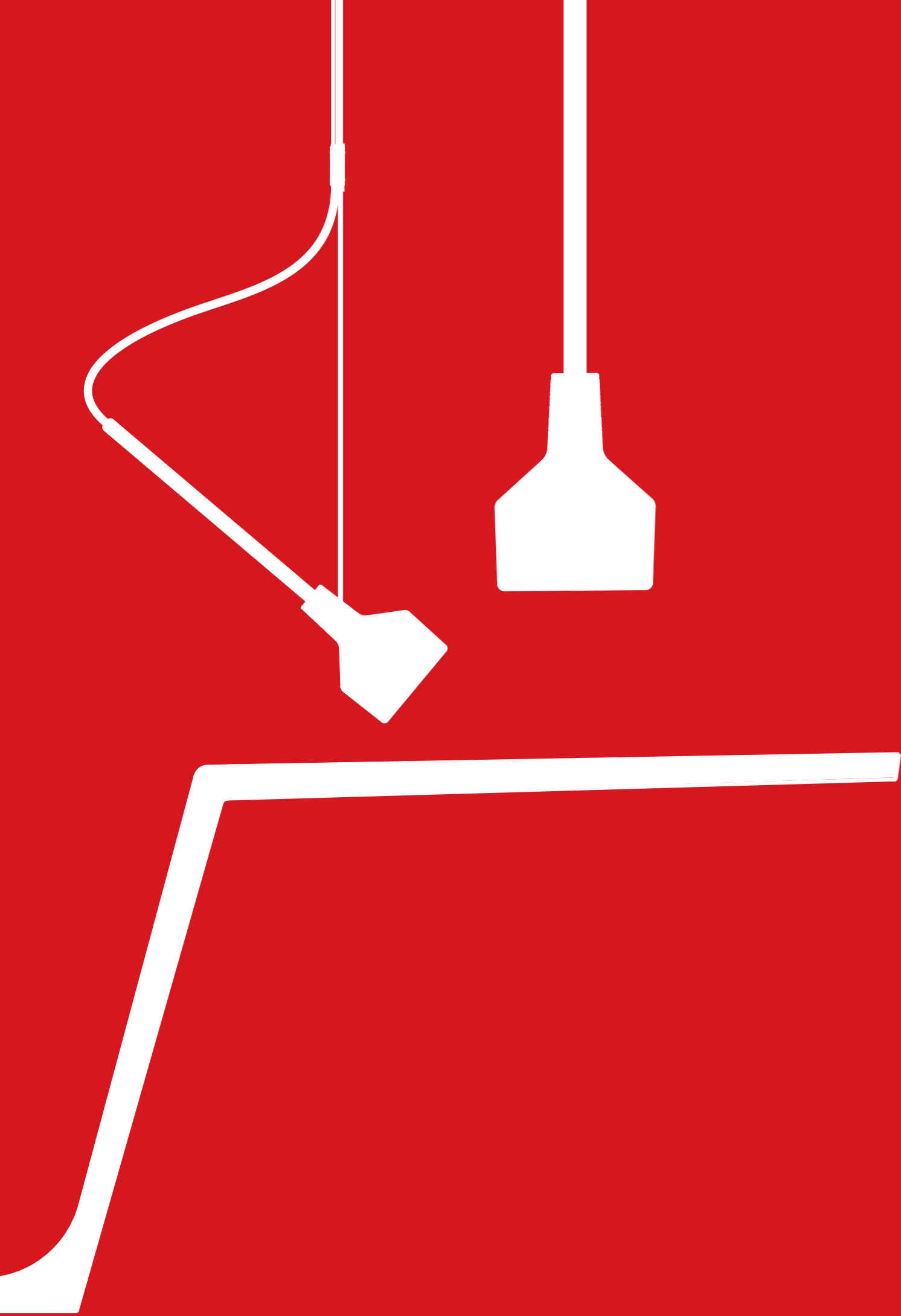



O-SOUND

DESIGN / CAMBI/SCATENA/TURINI

O-SOUND 5 (Suspension)

Color



5 x 22W 2GX13 T5



Certifications

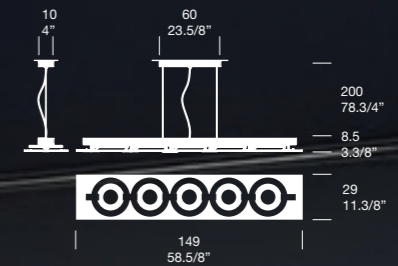

Minimalistic pendants with a round, silk-screened image on transparent rectangular glass. Available in 3 sizes, O-Sound pendants are cord and cable suspended with canopy and details in arctic grey metal. Orange, light blue, fuchsia and yellow diffusers are available on request for the addition of color to the series.

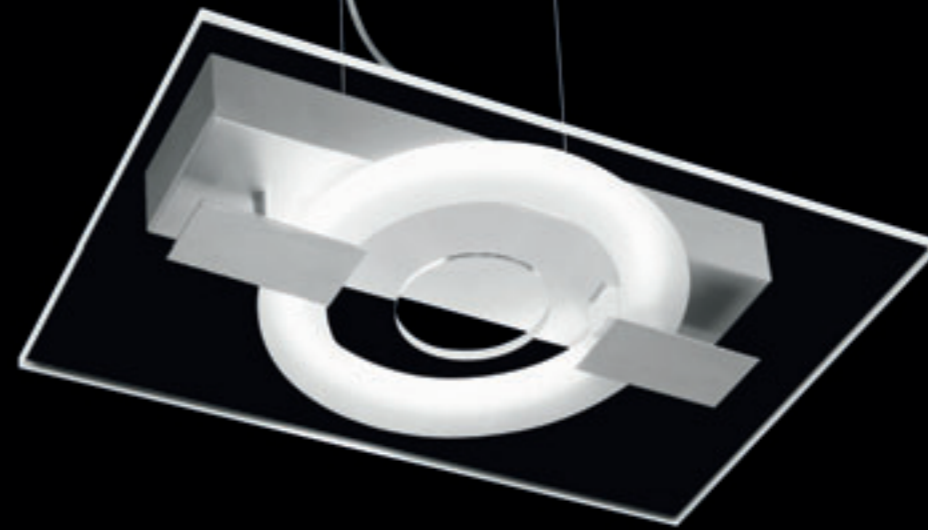

O-SOUND

DESIGN / CAMBI/SCATENA/TURINI

Minimalistic pendants with a round, silk-screened image on transparent rectangular glass. Available in 3 sizes, O-Sound pendants are cord and cable suspended with canopy and details in arctic grey metal. Orange, light blue, fuchsia and yellow diffusers are available on request for the addition of color to the series.

0-SOUND 1 (Suspension)

Color



1 x 22W 2GX13 T5



Certifications



0-SOUND 3 (Suspension)

Color



3 x 22W 2GX13 T5



Certifications



0-SOUND 1

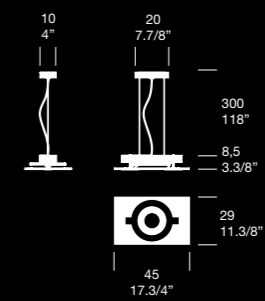

0-SOUND 3

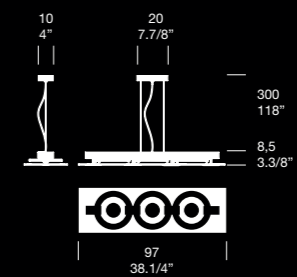

Minimalistic wall or ceiling designs with a round, silk-screened image on transparent rectangular glass. Metal details are arctic grey and three sizes of O-Sound are available. Orange, light blue, fuchsia and yellow diffusers are available on request for the addition of color to the series.

O-SOUND 5 (Wall-Ceiling)

Color

5 x 22W 2GX13 T5

Certifications 

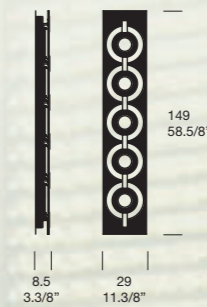

O-SOUND

DESIGN / CAMBI/SCATENA/TURINI









O-SOUND 3 (Wall-Ceiling)

Color

3 x 22W 2GX13 T5

Certifications    

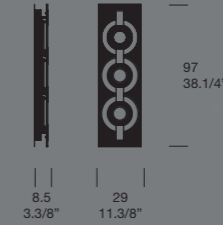

Minimalistic wall or ceiling designs with a round, silk-screened image on transparent rectangular glass. Metal details are arctic grey and three sizes of O-Sound are available. Orange, light blue, fuchsia and yellow diffusers are available on request for the addition of color to the series.

O-SOUND

DESIGN / CAMBI/SCATENA/TURINI





Minimalistic wall or ceiling designs with a round, silk-screened image on transparent rectangular glass. Metal details are arctic grey and three sizes of O-Sound are available. Orange, light blue, fuchsia and yellow diffusers are available on request for the addition of color to the series.

O-SOUND 1 (Wall-Ceiling)

Color



1 x 22W 2GX13 T5



Certifications

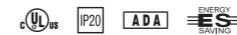

O-SOUND

DESIGN / CAMBI/SCATENA/TURINI



AIR

DESIGN / FLUSSO DESIGN





Artistic wall or ceiling design with a diffuser finished in a satin white and mirror-like surface. Air is available in two sizes with a fluorescent light source. Both versions are ADA compliant when wall mounted.

AIR 45	
Color	<input checked="" type="radio"/>
1 x 22W 2GX13 T5	<input checked="" type="radio"/>
Certifications	   
AIR 60	
Color	<input checked="" type="radio"/>
1 x 55W 2GX13 T5	<input checked="" type="radio"/>
Certifications	   

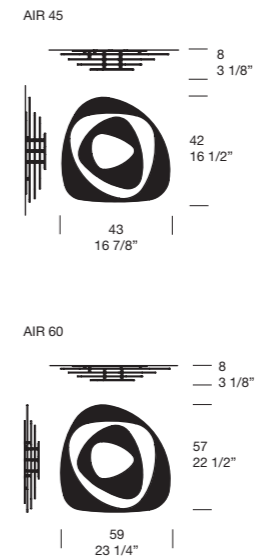



Large-scale suspension design fabricated with okoume wood. The open and airy frame is available in it's natural finished wood or painted white or dark grey with matching canopy. The LED sources are shielded with white polycarbonate diffusers.

AKI

DESIGN / STUDIO DREIMANN





AKI

Colors



40W LED 3000K 2900lm

Certifications

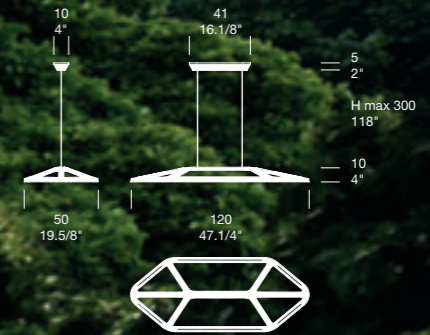

AKI

DESIGN / STUDIO DREIMANN



ALA (Ceiling)

Colors

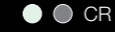

1 x max 200W - R7s (Long)



Certifications

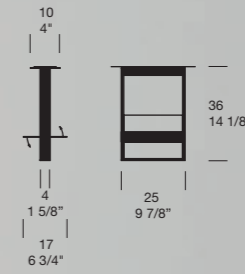

ALA

DESIGN / MAURO MARZOLLO



Sleek ceiling design with an adjustable diffuser for light direction. Finish options include a polished chrome structure with chrome or transparent glass and a white structure with white or transparent glass diffuser.



ALA (Wall)

Colors CR





1 x max 200W - R7s (Long)

Certifications   

ALA PICCOLA (Wall)

Colors CR

1 x max 40W - G9

Certifications    



ALA PICCOLA

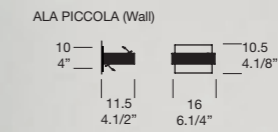
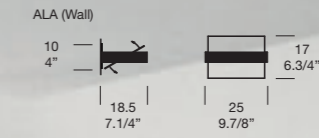

ALA

DESIGN / MAURO MARZOLLO

Sleek wall sconce available in two sizes with an adjustable diffuser for light direction. Finish options include a polished chrome structure with chrome or transparent glass and a white structure with white or transparent glass diffuser.



 ALIAS

 Colors ● ● ○

 1 x 150W B15d ⚡

 Certifications

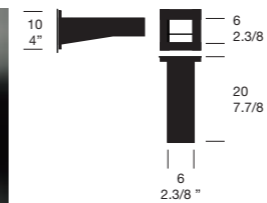

ALIAS

DESIGN / WORKS STUDIO: TONETTO/LAZZARI

Architectural wall sconce that provides up and down light from its halogen light source. Three metal finishes are available; brushed nickel, polished chrome or white lacquer. Lower glass shield in frosted pyrex.



ALIAS

DESIGN / WORKS STUDIO: TONETTO/LAZZARI

Sleek and clean-lined wall sconce available in 2 sizes and multiple light sources. Metal finish options include; brushed nickel, polished chrome and white lacquer. Lower glass shield in frosted pyrex.

ALIAS 35

Colors



2 x 18W G24q-2



Certifications



2 x max 100W - R7s (Long)



Certifications



LED 23W 3000K 2780lm

Certifications



ALIAS 15

Colors



1 x max 100W - R7s (Short)



Certifications



LED 16W 3000K 1300lm

Certifications



ALIAS 15



ALIAS 35

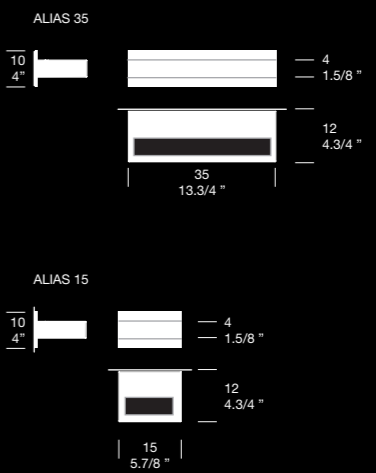





Elegant and simple, the Aria suspension is available in two sizes. Hand-blown, clear glass diffusers appear to float on these suspensions that have details in lacquered white metal. The LED light sources are dimmable and concealed in the upper portion of the pendants.

ARIA S36

Color CR

2 x 13W LED 3000K 1800lm

Certifications   

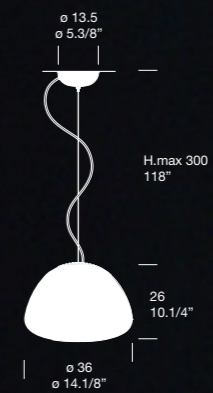

ARIA

DESIGN / IOSA GHINI





ARIA S18

Color

CR

1 x 13W LED 3000K 900lm

Certifications

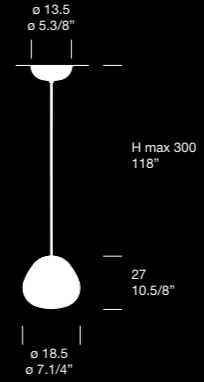

Elegant and simple, the Aria suspension is available in two sizes. Hand-blown, clear glass diffusers appear to float on these suspensions that have details in lacquered white metal. The LED light sources are dimmable and concealed in the upper portion of the pendants.

AXEL

DESIGN / STEVEN HAULENBEEK





Circular suspension design that provides diffused illumination from its LED or compact fluorescent light source options. The exterior of this sleek pendant is a compact poluyurethane resin finished in matte or glossy white. Axel also has an internal, opal white polymer diffuser. " Dual Inside " version is an option with Blue Tooth and Speaker features.

AXEL

Color

1 x 55W 2GX13 T5

Certifications



LED 36W 3000K 2600lm

Certifications



AXEL (DUAL INSIDE VERSION)

LED 36W 3000K 2600lm

Certifications

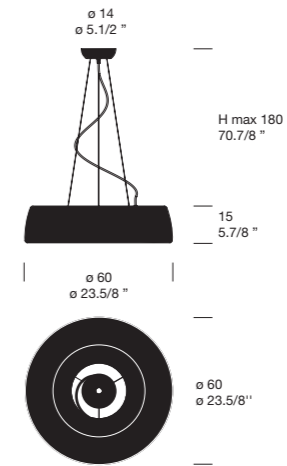

Dimmable electronic ballast included/ Remote control included/ 3-step white light dimmer/ FM radio/ Bluetooth 2.0 connection





BEAMER 11 S

Color



LED 6W 3000K 450lm

Certifications



1 x max 35W GU4



Certifications

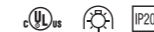

Kit "A" consists of one swag and one inclination kit.

BEAMER 11 S
(STANDARD)

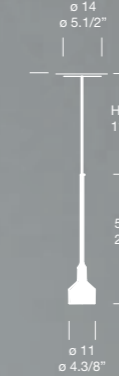

BEAMER 11 S
(WITH OPTIONAL KIT "A")

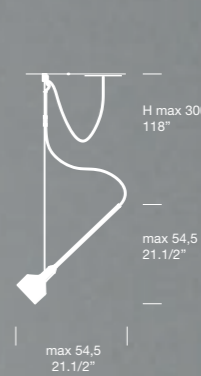

Beamer is a pendant design available as a single unit or other configurations that incorporate multiple Beamers suspended together at different angles and swagged. Beamer is composed of borosilicate glass with a shaded chrome-plated finish and polished chrome stem detail. Available in two sizes, Beamer becomes semi-transparent when lit. Light source options include LED and halogen.

BEAMER

DESIGN / ARIK LEVY





BEAMER 17 S

Color

LED 8W 3000K 600lm

Certifications



1 x max 50W GU5,3



Certifications



Kit "A" consists of one swag and one inclination kit.

BEAMER 17 S (STANDARD)



BEAMER 17 S (WITH OPTIONAL KIT "A")

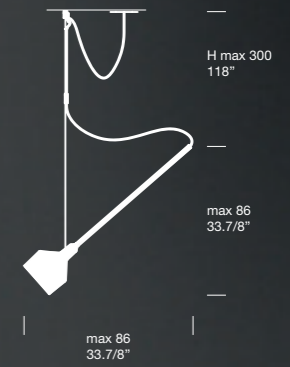

BEAMER

DESIGN / ARIK LEVY

Beamer is a pendant design available as a single unit or other configurations that incorporate multiple Beamers suspended together at different angles and swagged. Beamer is composed of borosilicate glass with a shaded chrome-plated finish and polished chrome stem detail. Available in two sizes, Beamer becomes semi-transparent when lit. Light source options include LED and halogen.



Beamer is a pendant design available as a single unit or other configurations that incorporate multiple Beamers suspended together at different angles and swagged. Beamer is composed of borosilicate glass with a shaded chrome-plated finish and polished chrome stem detail. Available in two sizes, Beamer becomes semi-transparent when lit. Light source options include LED and halogen.

BEAMER
DESIGN / ARIK LEVY

BEAMER 11 S3 - BEAMER 11 S-R3

Color	<input type="radio"/>
LED 3 x 6W 3000K 1350lm	
Certifications	
3 x max 35W GU4	
Certifications	

BEAMER 17 S-R3

Color	<input type="radio"/>
LED 3 x 8W 3000K 1800lm	
Certifications	
3 x max 50W GU5,3	
Certifications	

BEAMER 11 S3
(WITH OPTIONAL SWAG KITS)

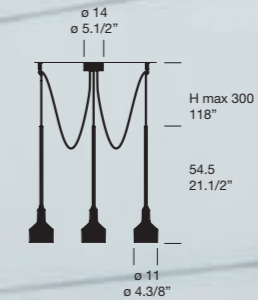

BEAMER 11 S-R3
(STANDARD)



BEAMER 11 S-R3
(WITH OPTIONAL INCLINATION KITS)

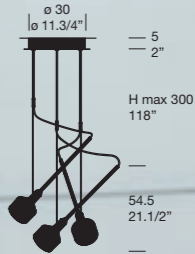

BEAMER 17 S-R3
(STANDARD)



BEAMER 17 S-R3
(WITH OPTIONAL SWAG KITS)

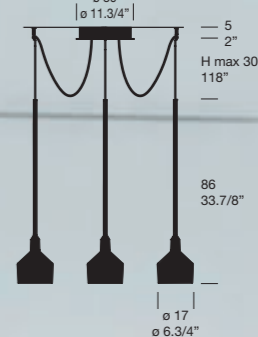

BEAMER 17 S-R3
(WITH OPTIONAL INCLINATION KITS)

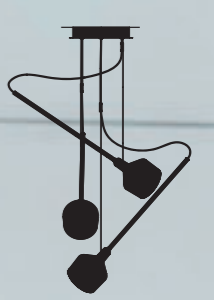





BEAMER

DESIGN / ARIK LEVY

BEAMER 11 S-R5

Color

LED 5 x 6W 3000K 2100lm

Certifications 

max 5 x 35W GU4 

Certifications 

BEAMER 17 S-R5

Color

LED 5 x 8W 3000K 3000lm

Certifications 

5 x max 35W GU5,3 

Certifications 

Beamer is a pendant design available as a single unit or other configurations that incorporate multiple Beamer's suspended together at different angles and swagged. Beamer is composed of borosilicate glass with a shaded chrome-plated finish and polished chrome stem detail. Available in two sizes, Beamer becomes semi-transparent when lit. Light source options include LED and halogen.

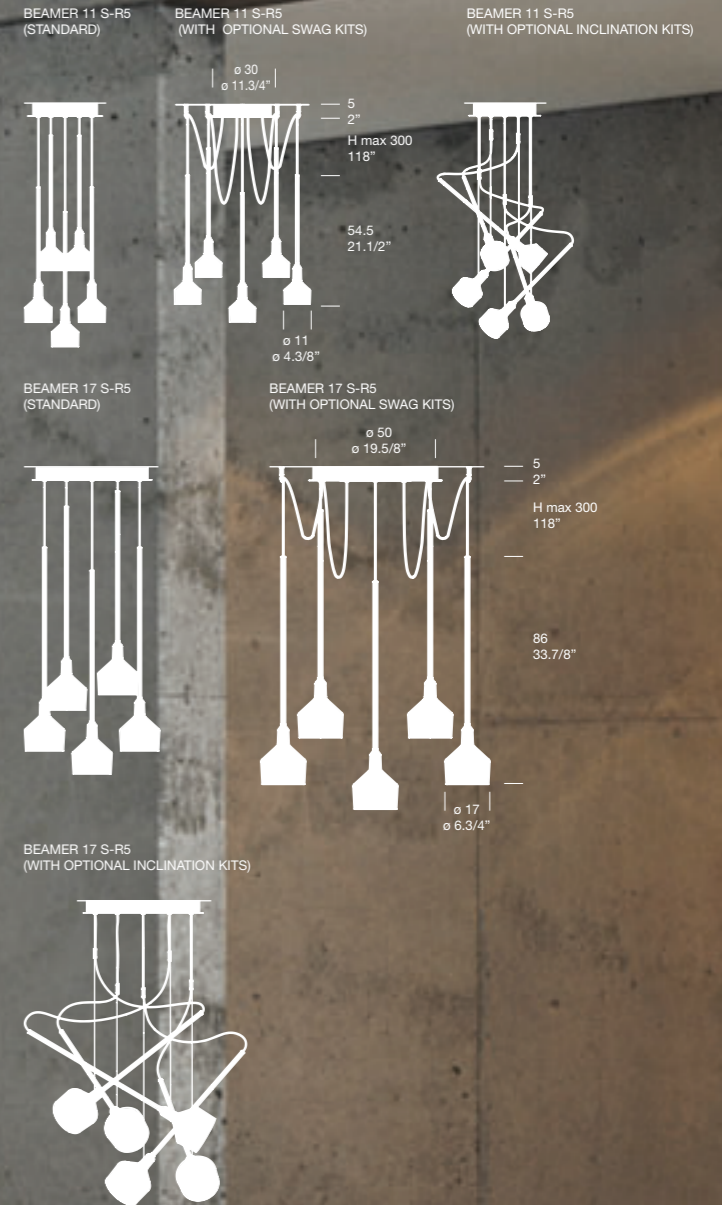



BLUMA





DESIGN / ALESSANDRO CROSEIRA

Circular wall or flush mount design with a satin acrylic diffuser and mirror-like center. Bluma has a compact fluorescent light source and frame in polished steel. ADA compliant when wall mounted.

BLUMA

Color

1 x 55W 2GX13 T5

Certifications    



CLASS

DESIGN / UFFICIO STILE



CLASS 40

Colors



1 x max 60W E12



Certifications

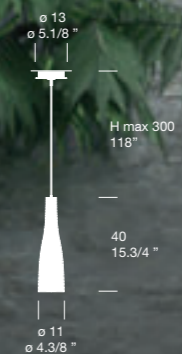

Classic suspension design in layered, hand-blown glass with wave-like, horizontal etching. Available in various sizes, finish options include; milky white, red bordeaux, dark brown, black, clear crystal and mirror. Clear cord is field adjustable and canopy is finished in light grey. Swag mount optional.



CLASS 120

Colors



1 x max 75W E26



1 x max 150W E26 (Halostar)



1 x 26W-G24q2



Certifications

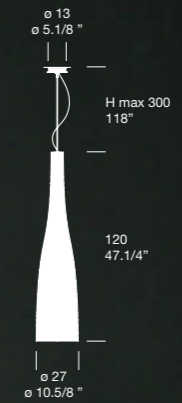

Impressive and large-scale suspension in layered, hand-blown glass with wave-like, horizontal etching. Finished in milky white glass, Class 120 is suspended with adjustable clear cord and cable with a canopy in light grey. Swag mount optional.

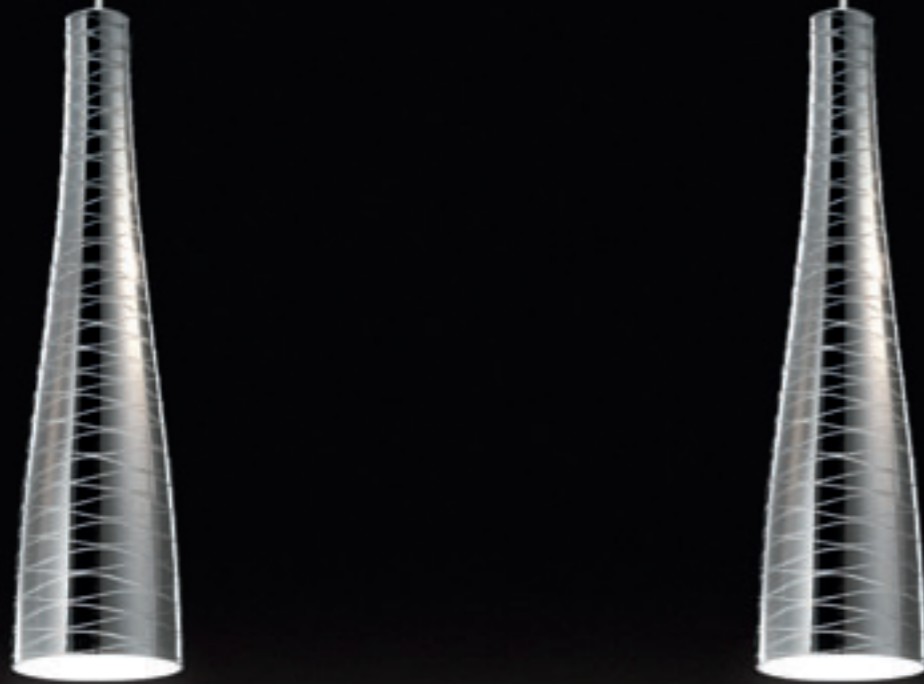

CLASS 60

Colors



1 x max 100W E26 (Halostar)



1 x max 75W E26



1 x 26W-G24q2



Certifications

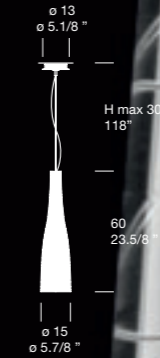
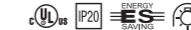

Classic suspension design in layered, hand-blown glass with wave-like, horizontal etching. Available in various sizes, finish options include; milky white, red bordeaux, dark brown, black, clear crystal and mirror. Clear cord is field adjustable and canopy is finished in light grey. Swag mount optional.









CUBI

DESIGN / UFFICIO STILE

CUBI 11 (Suspension)

Color



1 x max 60W G9 

Certifications   

CUBI 16 (Suspension)

Color

1 x max 100W B15d 

Certifications   



CUBI 11 (Suspension)

11
4.3/8"

H max 300
118"

20
7.7/8"

11
4.3/8"

11
4.3/8"

CUBI 16 (Suspension)

11
4.3/8"

H max 300
118"

23.5
9.1/4"

16
6.1/4"

16
6.1/4"

Clean-lined suspension design with hand-blown, layered satin white glass diffuser available in two sizes. Structure and matching square canopy are finished in arctic grey metal and cord heights are field adjustable.



CUBI

DESIGN / UFFICIO STILE

Clean-lined wall or ceiling design with hand-blown, layered satin white glass diffuser. ADA compliant for wall applications. CUBI 28 offers LED, compact fluorescent and incandescent lamp options. Frame in painted antic grey metal.



CUBI 28 (Wall-Ceiling)

Color

4 x max 40W E12 

Certifications



LED 15W 3000k 1800lm

Certifications



2 x 26W G24-q3 

Certifications



With electromagnetic ballast

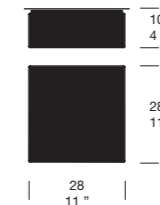

Cube-like wall or ceiling design with hand-blown, layered satin white glass diffuser. Available in two sizes, light source options include LED and halogen. Backing in painted artic grey.

CUBI 11 (Wall-Ceiling)

Color

1 x max 40W G9 

Certifications    

LED 6,4W 3000K 500lm

Certifications  

CUBI 16 (Wall-Ceiling)

Color

1 x max 60W G9 

Certifications    

LED 17,5W 3000K 1320lm

Certifications  

CUBI 11

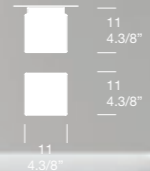

CUBI 16

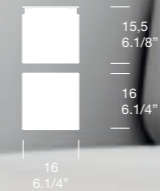

DOT

DESIGN / CARMEN FERRARA



Retro ceiling design with adjustable cylinder for look and light application. The inner ribbed cylinder is polished chrome on all models and the lower, adjustable element is available in the following finishes; white inside and outside, black inside and outside or polished chrome outside with white inside.



DOT	
Colors	<input type="radio"/> <input type="radio"/> <input type="radio"/>
1 x 26W GX24q-3	
1 x max 75W E26 BR30	
Certifications	

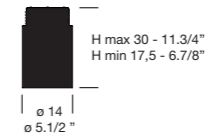

DOT

DESIGN / CARMEN FERRARA

This sharp-lined LED task light boasts a distinctive silhouette that sets it apart. Composed of compact polyurethane resin finished in gloss white, Flecha is turned on via a smooth touch dimmer at the top and a simple glide of the finger controls the light level. Flecha includes a USB adapter to plug in gadgets.

FLECHA

DESIGN / JORGE PENSI

FLECHA T

Color

LED 8W 3000K 650lm

Certifications

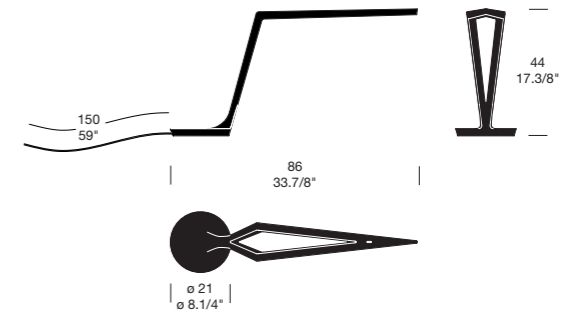





FLECHA P-PL

Color



LED 14W 3000K 1300lm

Certifications

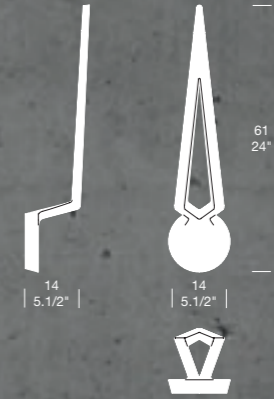

FLECHA

DESIGN / JORGE PENSI

A sleek wall sconce composed of compact polyurethane resin in gloss white, Flecha appears arrow-like and sharp. The LED light source is emitted onto the wall surface for smooth ambient light diffusion.



FLECHA

DESIGN / JORGE PENSI





FLECHA

DESIGN / JORGE PENSI

Slim and sleek, the Flecha suspension boasts a distinctive silhouette. Composed of compact polyurethane resin in gloss white, the LED light source is shielded and diffused at bottom with micro-prismatic diffusers.





GIÒ 30 P-PL

Colors



1 x max 60W E26



1 x max 20W E26 CFL



Certifications



Classic wall or ceiling design with a central, blown-glass diffuser in satin white. The square glass element is available in two sizes and five finishes; red, orange, white, satin crystal or mirror.

GIÒ

DESIGN / MICHELE SBROGIÒ





GIÒ 40 P-PL	
Colors	
2 x max 75W E26	
2 x max 26W GU24	
Certifications	

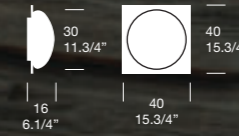

Classic wall or ceiling design with a central, blown-glass diffuser in satin white. The square glass element is available in two sizes and five finishes; red, orange, white, satin crystal or mirror.



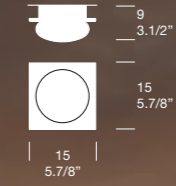

MINIGIÒ P-PL

Colors



1 x max 40W halopin G9



Certifications



MINIGIÒ

DESIGN / MICHELE SBROGIÒ

Small-scale wall or ceiling design with a central, blown-glass diffuser in satin white. The square glass element is available in two sizes and five finishes; red, orange, white, satin crystal or mirror. Looks great in multiples as shown.

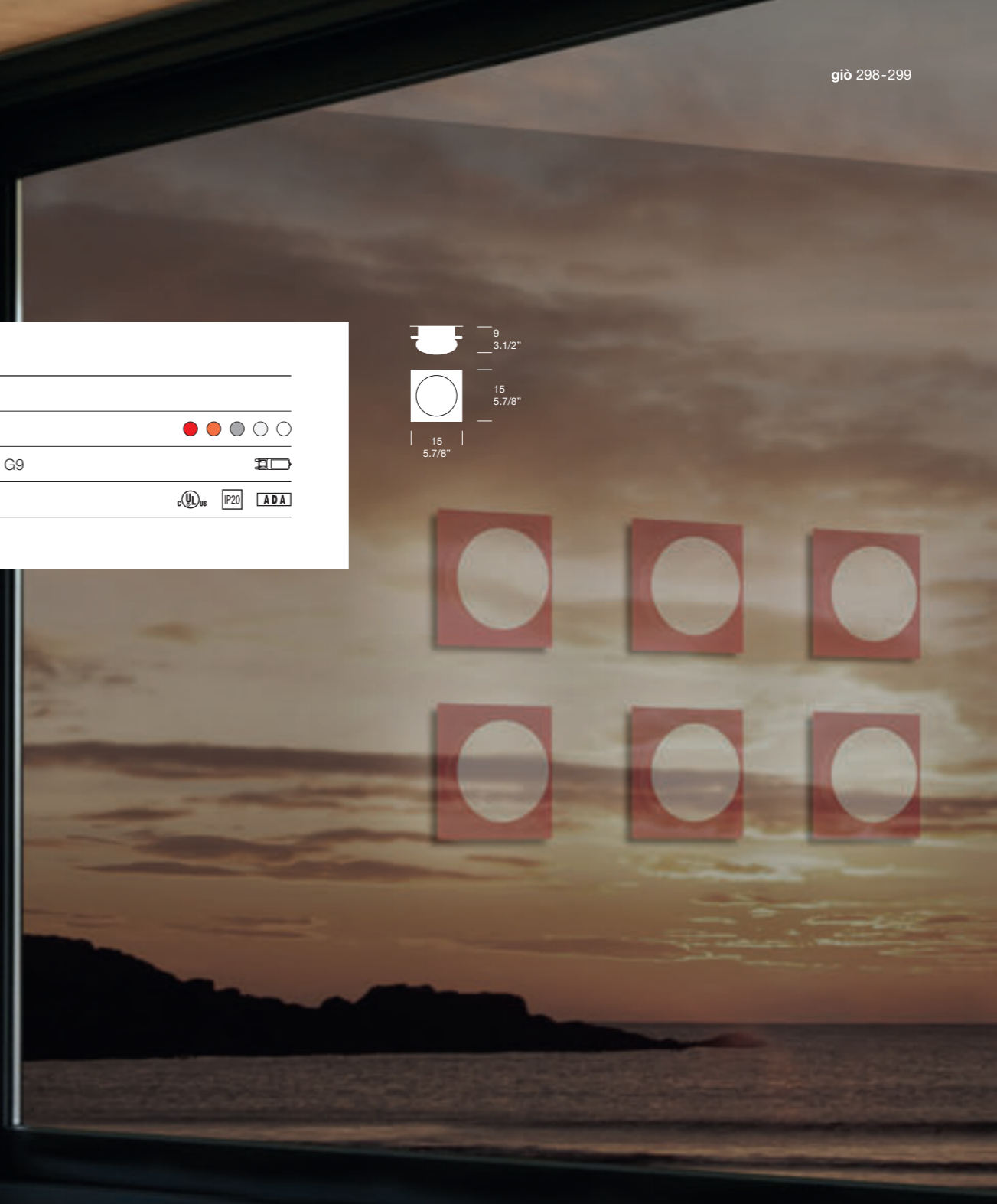



Pendant design highlighted by a circular ebony ring and hand-blown, satin white glass diffuser which conceals the light source. Canopy and details are in satin aluminum and the clear cord is field adjustable.

GIUKÓ

DESIGN / WORKS STUDIO: TONETTO/LAZZARI

GIUKÓ 1 (Suspension)

Color



1 x max 40W G9



Certifications

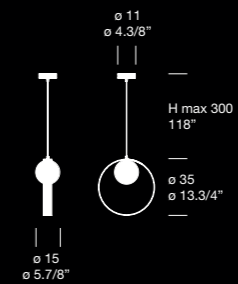



GIUKÓ 1 (Wall-Ceiling)

Color



1 x max 40W G9



Certifications



Unique wall or ceiling design highlighted by a circular ebony ring and hand-blown, satin white glass diffuser which conceals the light source. Canopy and details are in satin aluminum.

GIUKÓ

DESIGN / WORKS STUDIO: TONETTO/LAZZARI



GIUKÓ 5 (Floor)

Color



5 x max 60W G9



Certifications

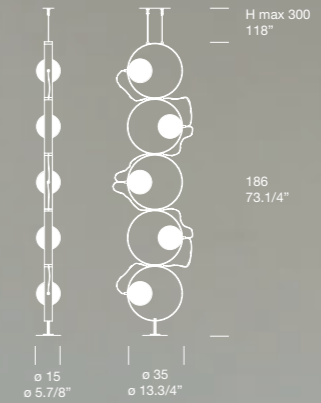

Unique suspended floor lamp highlighted by circular ebony rings and hand-blown, satin white glass diffusers which conceal the light sources. Satin aluminum details and an on/ off switch on the plug-in cord not shown.

GIUKÓ

DESIGN / WORKS STUDIO: TONETTO/LAZZARI





ISIS

DESIGN / ALESSANDRO PIVA

ISIS

Colors



2 x max 50W GU10



2 x max 18W GU24



Certifications



Sleek and architectural wall sconce in metal with an asymmetric diffuser. ADA compliant and available in matte white or charcoal grey, Isis is available with various lamp option.

To mount on single gang j-box



To mount on standard j-box

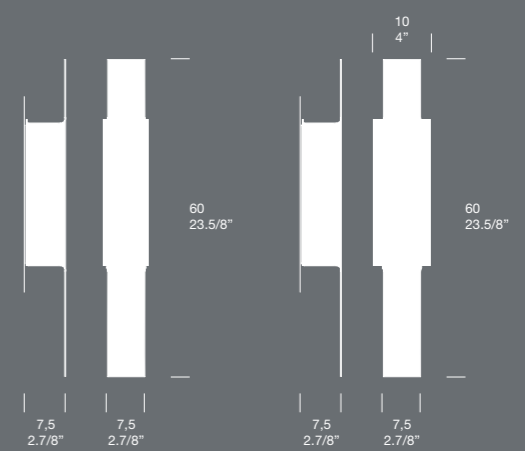



THE GREAT JJ (Suspension)

Colors

1 x max 250W E26 (Halostar)

Certifications

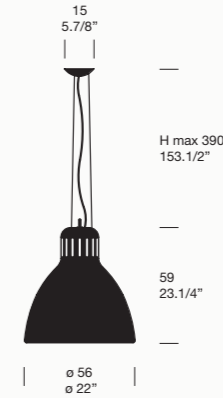

THE GREAT JJ

DESIGN / CENTRO STILE

Classic, large-scale suspension design available in five finishes; matte or glossy white, matte or glossy black or matte light grey. All versions have an inner white diffuser for lamp efficiency. The Great JJ's are cable and cord suspended for height adjustability and all versions have a rounded white canopy.





THE GREAT JJ

DESIGN / CENTRO STILE





Iconic design in a very large-scale floor lamp, The Great JJ is available in five painted finishes: matte or glossy white, matte or glossy black or matte light grey. Highly adjustable and with a heavily weighted base, The Great One comes in both interior and outdoor versions. Details are in polished chrome and all inner diffusers are finished in white for maximum light output.

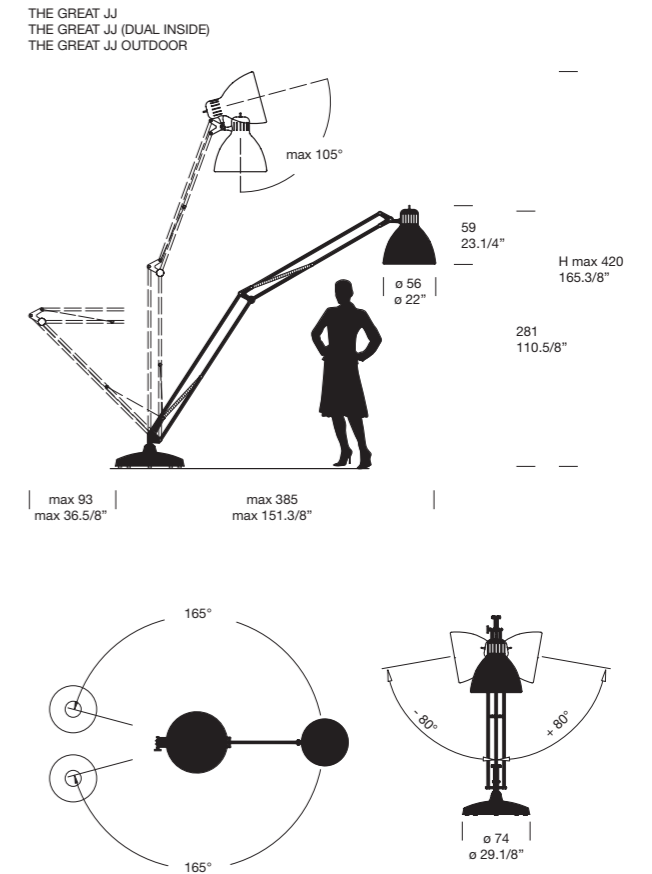

THE GREAT JJ (Floor)

Colors

1 x max 250W E26 (Halostar)

Certifications

THE GREAT JJ (Dual inside version)

Colors

1 x max 250W E26 (Halostar)

Certifications

Dimmable electronic ballast included/ Remote control included/ 3-step white light dimmer/ FM radio/ Bluetooth 2.0 connection



THE GREAT JJ OUTDOOR

DESIGN / CENTRO STILE

Iconic design in a very large-scale floor lamp, The Great JJ is available in five painted finishes: matte or glossy white, matte or glossy black or matte light grey. Highly adjustable and with a heavily weighted base, The Great One comes in both interior and outdoor versions. Details are in polished chrome and all inner diffusers are finished in white for maximum light output.

THE GREAT JJ OUTDOOR (Floor)

Colors

1 x max 70W G8,5 

Certifications  

Wet location



JJ

Colors



1 x max 60W E26 (Frost)



Certifications



Supplied with clamp A-AX coupling. Base in painted aluminium available upon request.

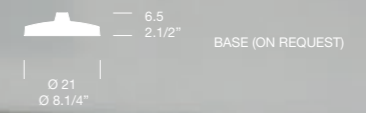
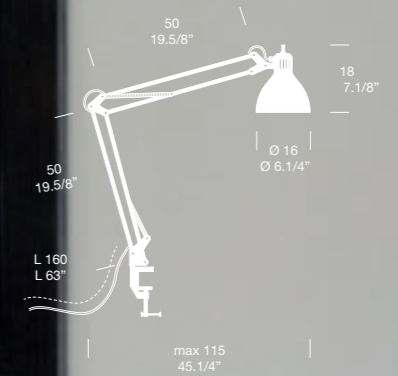

JJ

DESIGN / CENTRO STILE

Classic design and highly adjustable task lamp, the JJ is available in five colors : matte or glossy white, matte or glossy black or matte light grey. Clamp version is standard but round base is available as an option. Consult for panel mount and custom office applications. On /off switch is located at the diffuser top.

JJ JUNIOR

DESIGN / CENTRO STILE

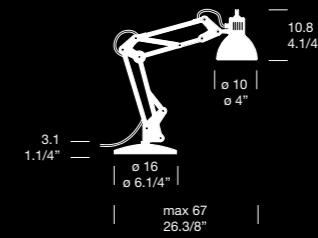

JJ JUNIOR (Table)

Colors



1 x max 40W E12



Certifications

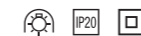

Smaller-scale version of the classic, JJ Junior comes standard with its round base and is highly adjustable. It is available in 5 finishes; matte or glossy white, matte or glossy black and matte light grey.



JJ JUNIOR

DESIGN / CENTRO STILE

Small scale, adjustable wall sconce. The JJ Junior wall is available in 5 finishes; matte or glossy white, matte or glossy black and matte light grey. On / off switch is located on the top of the diffuser. JJ Junior is a cord and plug design and not wired to a J Box. Cord is not shown in photograph.



JJ JUNIOR (Wall)

Colors



1 x max 60W E26



Certifications



Provided with wall bracket.

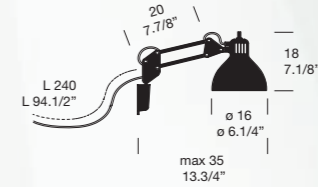

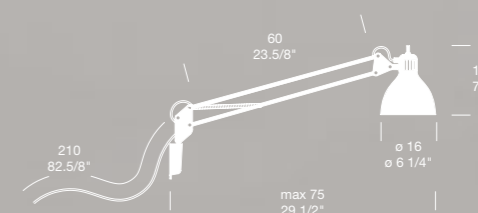

JJ M

DESIGN / CENTRO STILE



JJ M	
Colors	● ● ○
1 x max 60W E26	💡
Certifications	UL CE IP20

Adjustable wall sconce, JJ M is available in 5 finishes; matte or glossy white, matte or glossy black and matte light grey. On / off switch is located on the top of the diffuser. JJ M is a cord and plug design and not wired to a J Box. Cord is not shown in photograph.



JJ

DESIGN / CENTRO STILE

Classically shaped suspension design available in five finishes; matte or glossy white, matte or glossy black or matte light grey. JJ pendant is cable and cord suspended for height adjustability. A medium base socket allows for numerous lamp options.

JJ S 22

Colors



1 x max 60W E26



Certifications

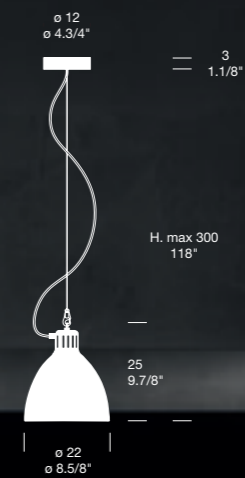



JJ TR 22

Colors



1 x max 60W E26



Certifications

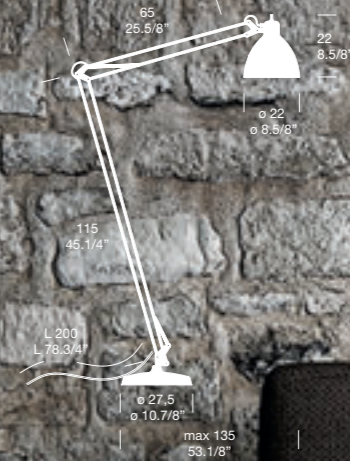
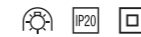

Classic design in a flexible and clean-lined floor lamp, JJ is available in five painted finishes; matte or glossy black, matte or glossy white or matte grey. On / off switch is located on the top of the JJ diffuser.

JJ

DESIGN / CENTRO STILE



KATANA

DESIGN / VALERIO COMETTI & PAOLO BALZANI



Striking and large-scale floor lamp with adjustability and 'Dual Inside' Blue tooth and speaker technology. LED illuminated, Katana is available in black or white carbon fiber with a brushed steel weighted base.

KATANA  (DUAL INSIDE VERSION)

Colors

24 x 1,2W LED 3000K 2300lm + 2,6 LED RGB

Certifications  

Dimmable electronic ballast included/ Remote control included/ 3-step white light dimmer/ FM radio/ Bluetooth 2.0 connection

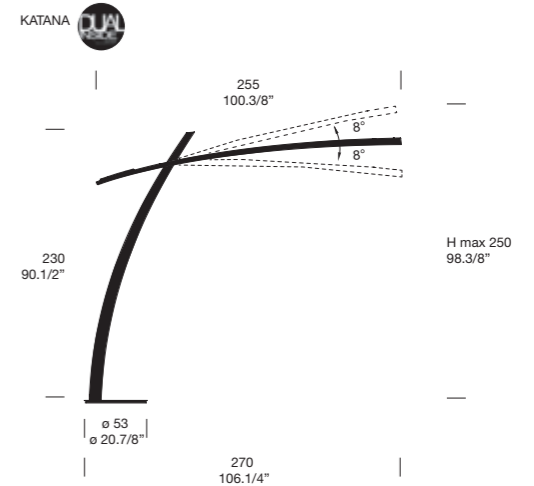





KATANA

DESIGN / VALERIO COMETTI & PAOLO BALZANELLI

Striking and large-scale floor lamp with adjustability and constructed of carbon fiber. Available in its natural transparent black or lacquered white, Katana has a brushed steel, weighted base and dimmable halogen light source.

KATANA	
Colors	<input type="radio"/> <input checked="" type="radio"/>
1 x max 200W R7s (Short)	<input type="range"/>
Certifications	  

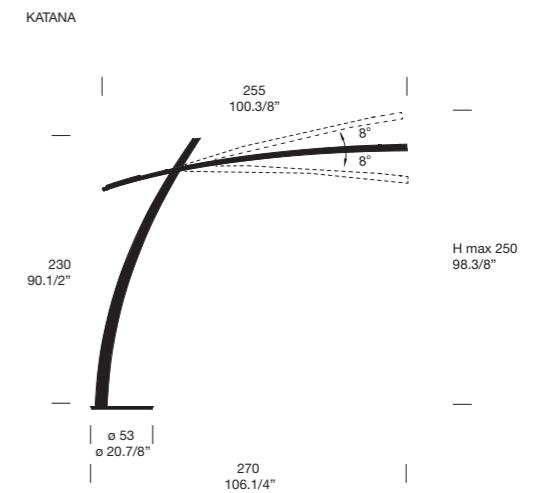

LEVA

DESIGN / IOSA GHINI



GOOD DESIGN AWARD
The Chicago Athenaeum 2012

IAI AWARDS 2012

Highly-adjustable task lamp finished in rich beech wood with metal details in natural steel. The LED light source is shielded with an opaline diffuser and controlled by a high-low switch on the Leva body. Clamp mount is standard and matching steel base is provided upon request.



LEVA

Color ●

9W LED 3000K 650lm

Certifications



Supplied with clamp A-AX. Base upon request

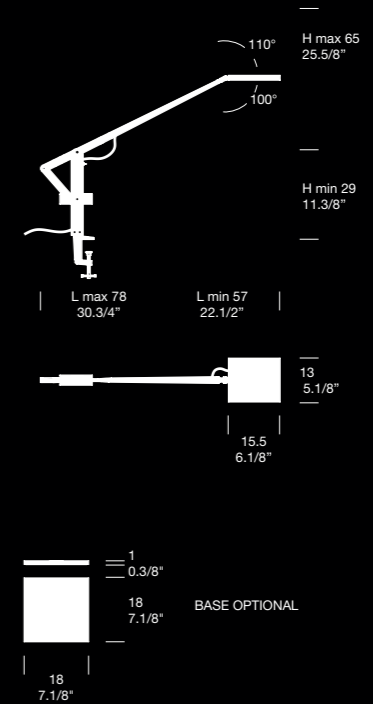



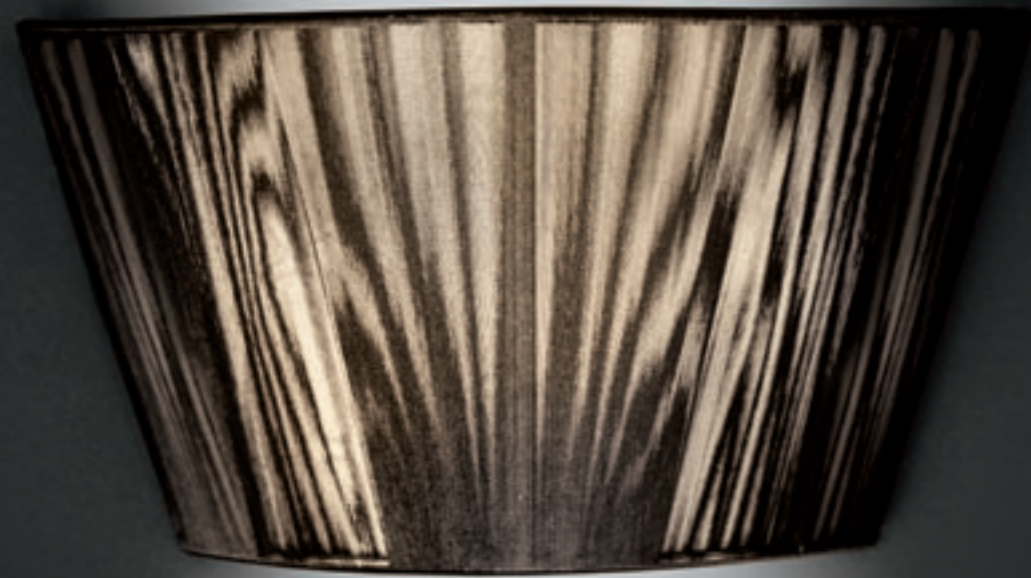

Classic-shaped wall sconce with an illusional effect created by threading across the front of the sconce. Color options include black, red, mocha, silver and white. Both up and down light are provided by the Lilith sconce.

LILITH
DESIGN / STUDIO ALTEAM

LILITH P

Colors



3 x max 25W - E12



1 x 18W-G24q2



Certifications

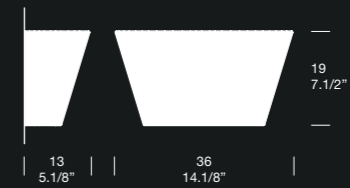



LILITH

DESIGN / STUDIO ALTEAM

Transitional ceiling mount highlighted by threading across the shade that create an illusional effect. Available in 3 diameters and 5 great colors : red, mocha, silver, black and white, all Lilith ceilings have a frosted shield at bottom and a brushed nickel detail.

LILITH PL 40

Colors

3 x max 40W E12

Certifications

LILITH PL 55

Colors

4 x max 40W E26

4 x 18W-G24q2

Certifications

LILITH PL 70

Colors

6 x max 40W E26

6 x 26W-G24q3

Certifications

LILITH PL 40

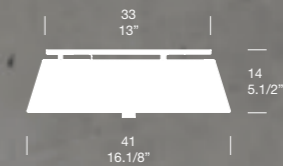

LILITH PL 55



LILITH PL 70

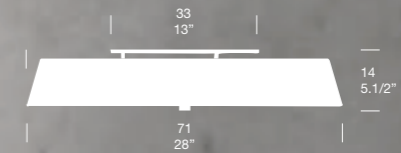



LILITH S 70

Colors



6 x max 75W E26



6 x 26W-G24q3



Certifications

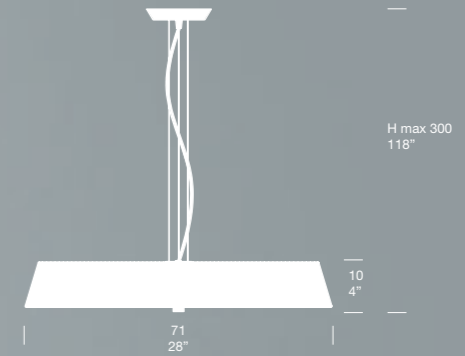

LILITH

DESIGN / STUDIO ALTEAM

Colorful suspension design highlighted by threading across the shade that create an illusional effect. Available in 3 diameters and 5 great colors : red, mocha, silver, black and white, all Lilith pendants have a frosted shield at bottom for light diffusion. Cable and cord suspension allow for height adjustment and ceiling canopy and bottom detail are in brushed nickel.



Colorful suspension design highlighted by threading across the shade that create an illusional effect. Available in 3 diameters and 5 great colors : red, mocha, silver, black and white, all Lilith pendants have a frosted shield at bottom for light diffusion. Cable and cord suspension allow for height adjustment and ceiling canopy and bottom detail are in brushed nickel.

LILITH S 40	
Colors	
3 x max 60W - E12	
Certifications	
LILITH S 55	
Colors	
4 x max 75W - E26	
4 x 18W-G24q2	
Certifications	

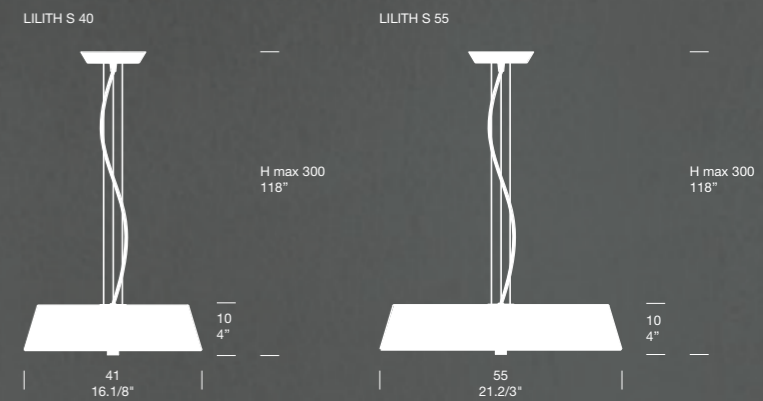

LILITH
DESIGN / STUDIO ALTEAM

Classic-shaped table lamp with an illusional effect created by threading across the shade. Color options include black, red, mocha, silver and white. Base and stem are in brushed nickel and there is a frosted glass shield at top to obscure lamp images.

LILITH T

Colors



3 x max 40W E12



Certifications





MIRAGE S

Color

1 x max 200W R7s (Long)

Certifications

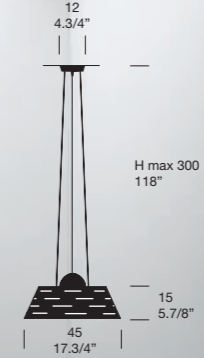

Striking pendant design with a blown glass, mirror-like diffuser with satin white horizontal details. Cable and cord suspended, Mirage has a matching polished chrome canopy and provides both up and downward light from its dimmable halogen light source.

MIRAGE

DESIGN / FILIPPO CAPRIOGLIO





MIRAGE

DESIGN / FILIPPO CAPRIOGLIO

Sleek wall sconce with a curved, mirror-like diffuser with satin white horizontal details. With structure in lacquered white metal, Mirage wall provides both up and downward light from its dimmable halogen light source.

MIRAGE P

Color

1 x max 150W R7s (Long)

Certifications

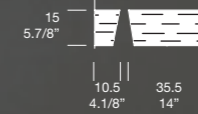









ONE



Colors

1 x max 75W R7s (short) 

Certifications    

2 x 3,6W LED 3000K 610lm

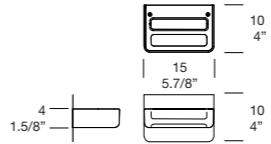
Certifications   



ONE

DESIGN / VALERIO COMETTI E V12 DESIGN

Sleek wall sconce that provides up and downlight from it's slender profile. Finish options include natural aluminum, matte white or polished chrome. Frosted pyrex shields the LED or halogen light source options.





Sleek wall sconce that provides up and downlight from it's slender profile. Finish options include natural aluminum, matte white or polished chrome. Frosted pyrex shields the LED or compact fluorescent light source options.

ONE 40

Colors

2 x 26W G24q-3

LED 24W 3000K 2100lm

Certifications

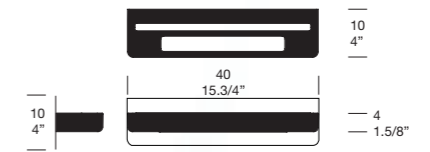
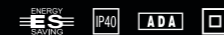

REGENCY

DESIGN / ALAN MITCHELL





Large-scale, drum shaped pendant with a cotton threaded shade in white or mocha. A frosted acrylic diffuser is provided to obscure view to the multiple light sources. Metal details are in satin nickel.

REGENCY	
Colors	
6 x max 75W E26	
6 x 26W-G24q3	
6 x 26W-GU24	
Certifications	

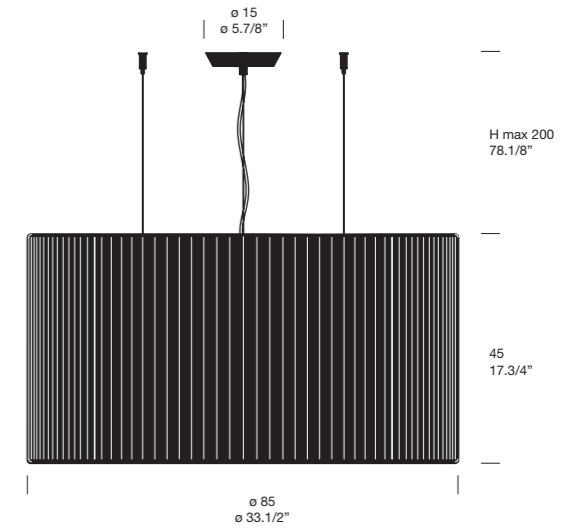

SD GHIBLI

Colors



3 x 2W LED 500mA (15° or 60°)

Certifications



Small-scale wall mount for indoor or exterior application. The LED light source emits a star-like pattern. The stainless structure is coated in natural aluminum, anodized black or matte white.

SD GHIBLI

DESIGN / VALERIO COMETTI E V12 DESIGN

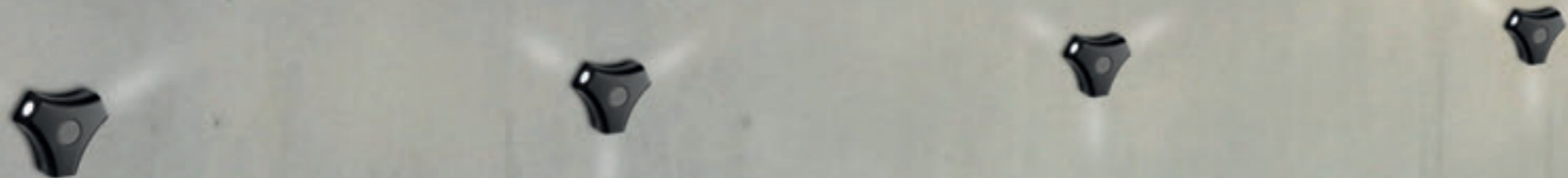

SD LIBO

DESIGN / VALERIO COMETTI E V12 DESIGN

Small-scale wall mount for indoor or exterior application. The LED light source emits both an up and down burst of light. The stainless structure is coated in natural aluminum, anodized black or matte white.

SD LIBO

Colors



2 x 2W LED 500mA (15° or 60°)

Certifications





RISE 70

Color



1 x 55W 2G11 (twin Tube)



Certifications

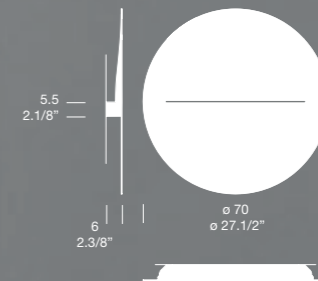

RISE

DESIGN / VALERIO COMETTI E V12 DESIGN

Circular wall sconce available in three sizes and various light sources. To mimic the sunrise, Rise features a horizontal reveal that emits upward light and all other illumination is diffused from behind the sconce. All versions are ADA compliant and finished in matte white.











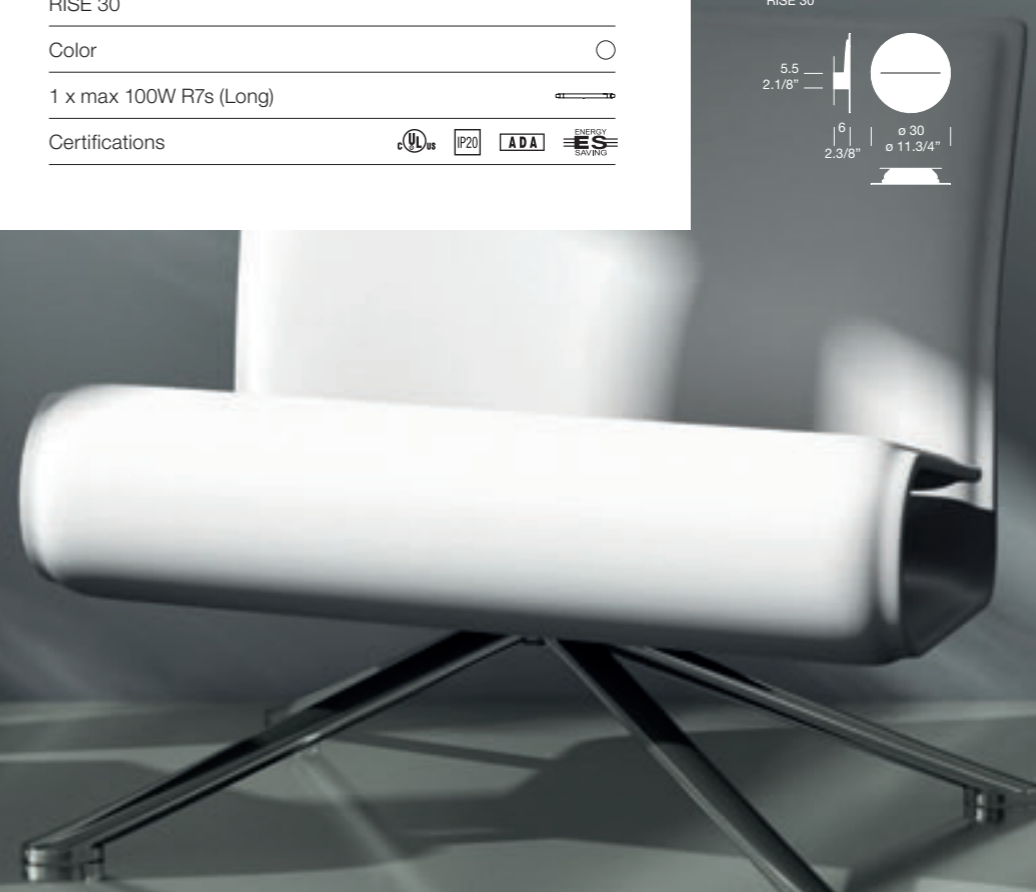



RISE

DESIGN / VALERIO COMETTI E V12 DESIGN

Circular wall sconce available in three sizes and various light sources. To mimic the sunrise, Rise features a horizontal reveal that emits upward light and all other illumination is diffused from behind the sconce. All versions are ADA compliant and finished in matte white.



RISE 45
Color <input type="radio"/>
1 x 24W 2G11 (twin Tube Long) 
Certifications    
With electronic ballast
RISE 30
Color <input type="radio"/>
1 x max 100W R7s (Long) 
Certifications    

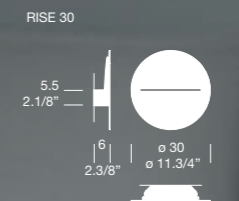
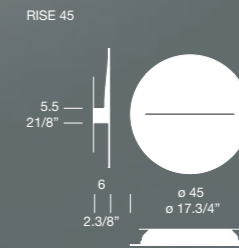



Mirror-like disks of highly reflective nature characterize the Sole Nero. Available in three sizes and numerous light sources, they can be wall or ceiling mounted. Structures are finished in white metal and all sizes are ADA compliant when wall mounted.

SOLE NERO

DESIGN / GIANLUCA ZIN & DDS

SOLE NERO P-PL 40

Color

1 x 22W 2GX13 T5

Certifications

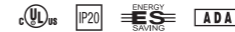

SOLE NERO P-PL 60

Color

3 x 20W E26 TC-TSE

Certifications

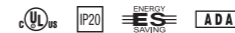

SOLE NERO P-PL 80

Color

3 x 20W E26 TC-TSE

Certifications

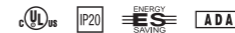

SOLE NERO P-PL 40



SOLE NERO P-PL 60

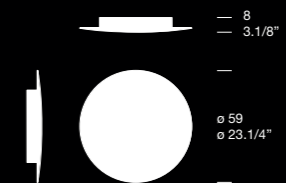

SOLE NERO P-PL 80

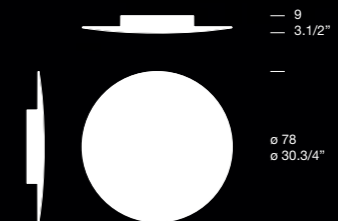

SYDNEY

DESIGN / VALERIO COMETTI E V12 DESIGN

Clean-lined suspension design in polished aluminum or a matte white finish available in two sizes.

SYDNEY 13 (Suspension)

Colors



1 x max 75W E26 halopar 30



1 x max 65W G53 12V



Certifications

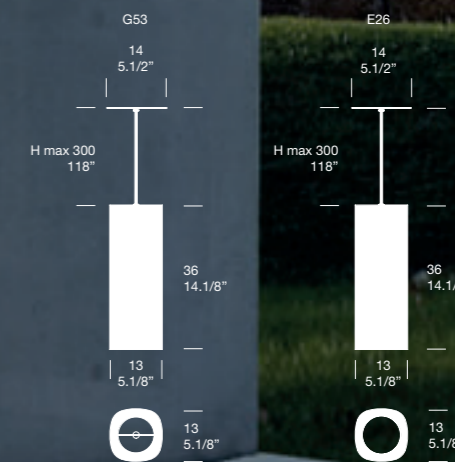



SYDNEY

DESIGN / VALERIO COMETTI E V12 DESIGN

Clean-lined suspension design in polished aluminum or a matte white finish available in two sizes. Light source options for this downlight include LED and halogen.

SYDNEY 6 (Suspension)

Colors

1 x max 7W GU10 MASTERLED

1 x max 11W GU10 MEGAMAN

1 x max 50W GU10

Certifications

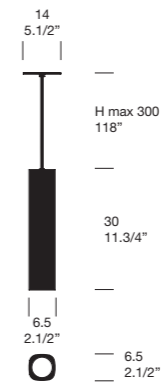



SYDNEY 13 (Ceiling)

Colors

1 x max 75W E26 halopar 30 

1 x max 65W G53 12V 

Certifications    

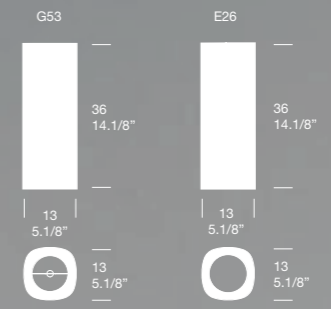

Sleek, architectural flush mount design in polished aluminum or a matte white finish available in three sizes.

SYDNEY

DESIGN / VALERIO COMETTI E V12 DESIGN



Sleek, architectural flush mount design in polished aluminum or a matte white finish available in three sizes. Light source options for this downlight include LED and halogen.

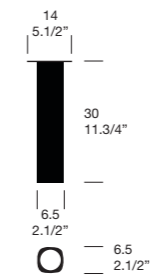
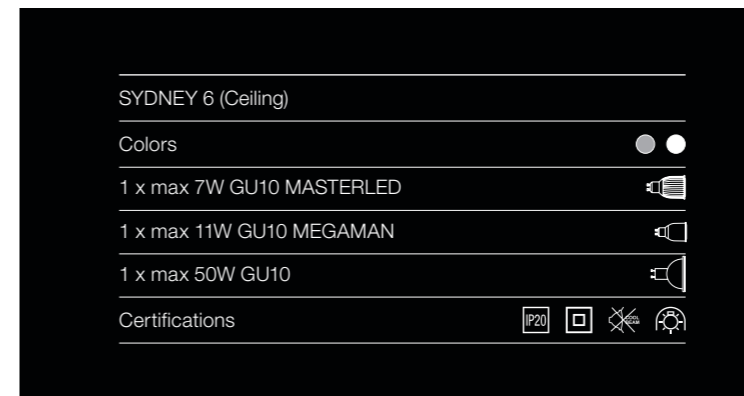

SYDNEY

DESIGN / VALERIO COMETTI E V12 DESIGN

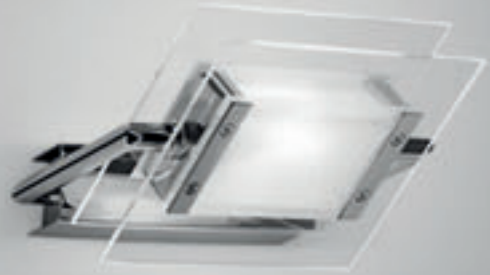

Wall sconce or ceiling design with adjustable diffuser for various lighting effects. The glass is transparent with a frosted center to shield the halogen light source. The 200 version is finished in white, polished chrome or satin nickel and the 370 model is available in polished chrome or satin nickel. Upon request, an aluminum shield is also available.

TRECENTOESSANTAGRADI

DESIGN / UFFICIO STILE

TRECENTOESSANTAGRADI 370

Colors

1 x max 200W R7s (Long)

Certifications

TRECENTOESSANTAGRADI 200

Colors

1 x max 200W R7s (Short)

Certifications



TRECENTOESSANTAGRADI 370

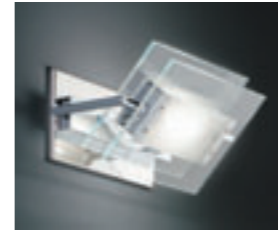

TRECENTOESSANTAGRADI 200

TRECENTOESSANTAGRADI 370

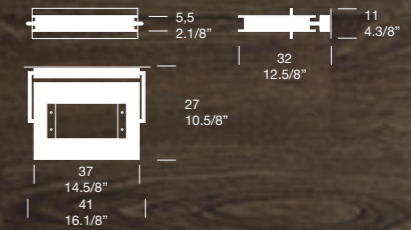

TRECENTOESSANTAGRADI 200

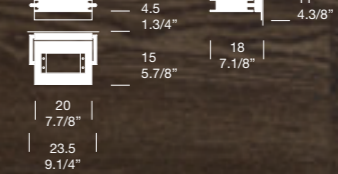

TRECENTOESSANTAGRADI

DESIGN / UFFICIO STILE

Wall sconce or ceiling design with adjustable diffuser for various lighting effects. The glass is transparent with a frosted center to shield the halogen light source. Backplate and structure is finished in white, polished chrome or satin nickel. Upon request, an aluminum shield is also available.

TRECENTOESSANTAGRADI 120

Colors

1 x max 75W G9

Certifications

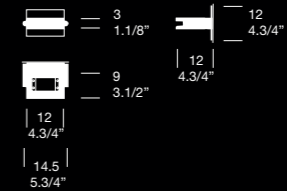



Wall sconce or ceiling design with adjustable diffuser for various lighting effects. The glass is transparent with a frosted center to shield the halogen light source. Backplate and structure is finished in polished chrome or satin nickel. Upon request, an aluminum shield is also available.

TRECENTOSESSANTAGRADI

DESIGN / UFFICIO STILE

TRECENTOSESSANTAGRADI 200 SNODO

Colors ● ●

1 x max 200W R7s (Short) ⏏

Certifications UL ENEC IP20

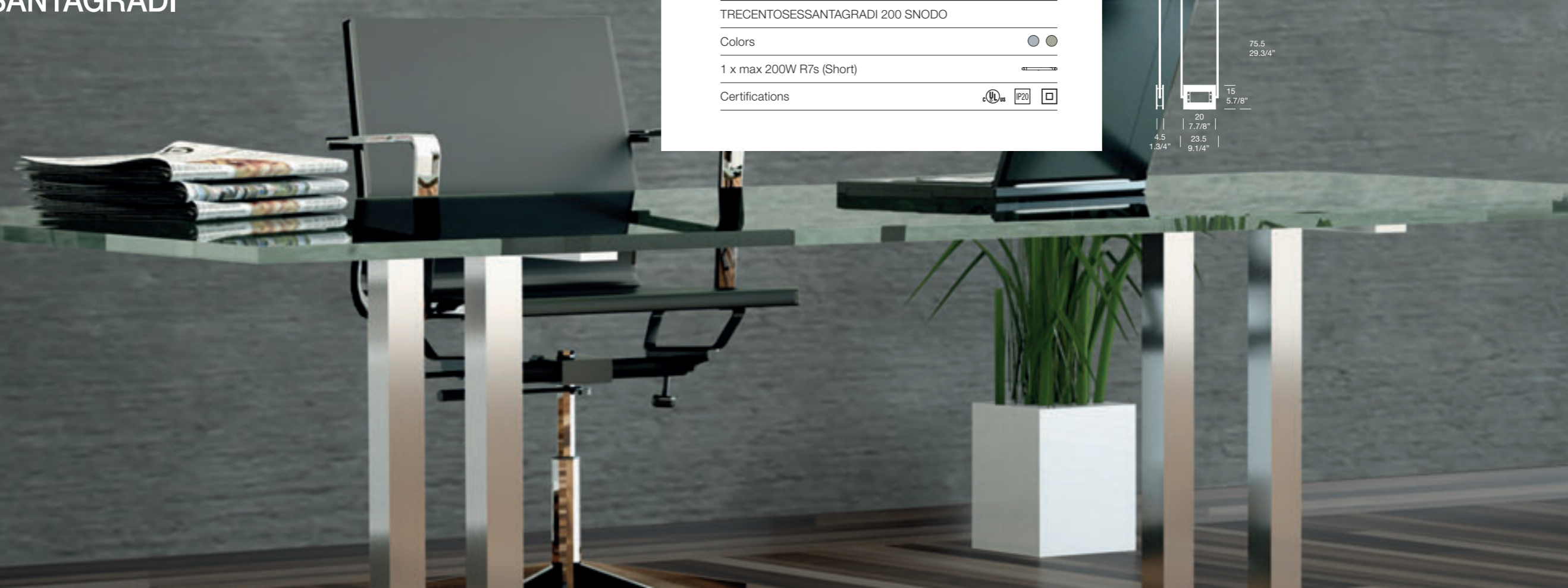
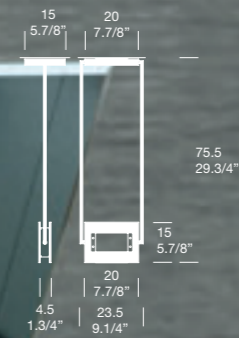



Pendant designs featuring a pleated and wrapped shade in white or mocha. Vanity S1, S2 and S3 are individual suspensions that include cables and power feed. Frosted acrylic diffuser shields are available upon request. CUSTOM COMPOSITIONS AVAILABLE UPON REQUEST.

VANITY

DESIGN / LINO CODATO



VANITY S1

Colors

3 x 60W E26 

3 x 26W-GU24 

Certifications    

VANITY 1

Colors

3 x 60W E26 

3 x 26W-GU24 

Certifications    

VANITY S1

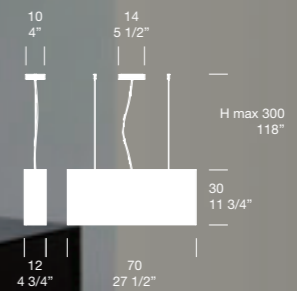

VANITY 1

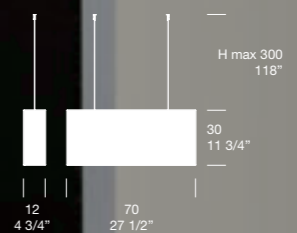



VANITY

DESIGN / LINO CODATO

Pendant designs featuring a pleated and wrapped shade in white or mocha. Vanity S1, S2 and S3 are individual suspensions that include cables and power feed. Frosted acrylic diffuser shields are available upon request. CUSTOM COMPOSITIONS AVAILABLE UPON REQUEST.

VANITY S3

Colors



3 x 60W E26



3 x 26W GU24



Certifications

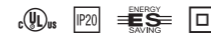

VANITY 3

Colors



3 x 60W E26



3 x 26W GU24



Certifications

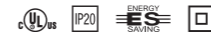

Composition models



Pendant designs featuring a pleated and wrapped shade in white or mocha. Vanity S1, S2 and S3 are individual suspensions that include cables and power feed. Frosted acrylic diffuser shields are available upon request. CUSTOM COMPOSITIONS AVAILABLE UPON REQUEST.

VANITY

DESIGN / LINO CODATO

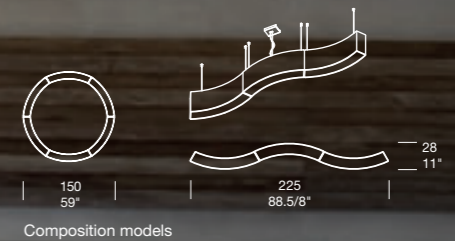
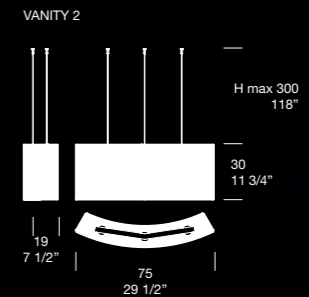
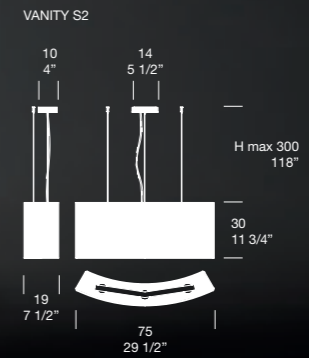

VANITY S2

Colors

3 x 60W E26 

3 x 26W GU24 

Certifications    

VANITY 2

Colors

3 x 60W E26 

3 x 26W GU24 

Certifications    

VANITY

DESIGN / LINO CODATO





X-RAY S35

Color



1 x 13W GU24



Certifications



X-RAY S65

Color



3 x 26W GU24



1 x 55W 2GX13 T5



Certifications



X-RAY S35

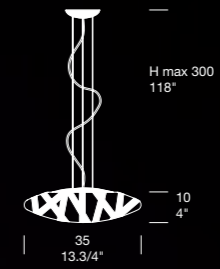

X-RAY S65

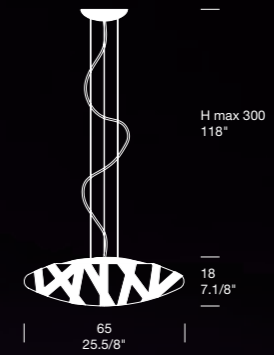

X-RAY

DESIGN / PAOLO DE LUCCHI & GIORGIA PAGANINI

Dimensional pendant formed from one piece of frosted white polycarbonate. Available in two sizes, X-Ray has a central cavity that conceals the light source above and is suspended with cable and cord that is field adjustable.



X-RAY P-PL 65

Color

3 x 26W GU24 

1 x 55W 2GX13 T5

Certifications 



18
7.1/8"

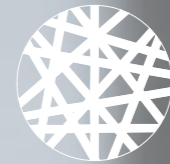

65
25.5/8"

X-RAY

DESIGN / PAOLO DE LUCCHI & GIORGIA PAGANINI

Dimensional wall or ceiling design formed from one piece of frosted white polycarbonate. Available in two sizes, X-Ray has a central cavity that conceals the light source. Backing in white lacquered metal.





Dimensional wall or ceiling design formed from one piece of frosted white polycarbonate. Available in two sizes, X-Ray has a central cavity that conceals the light source. Backing in white lacquered metal.

X-RAY P-PL 35

Color



1 x 13W GU24



Certifications



10
4"

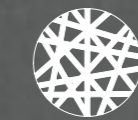

35
13.3/4"

X-RAY

DESIGN / PAOLO DE LUCCHI & GIORGIA PAGANINI

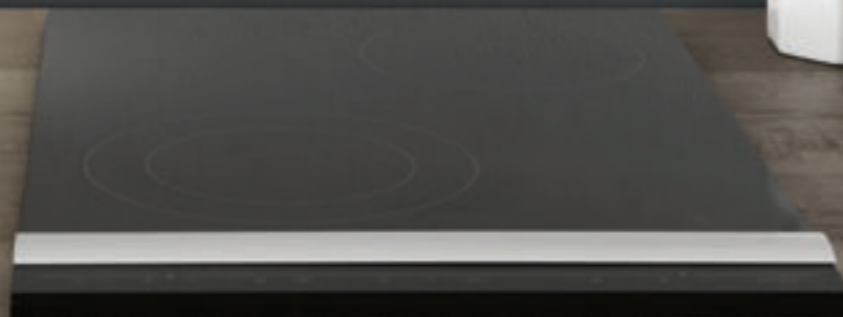

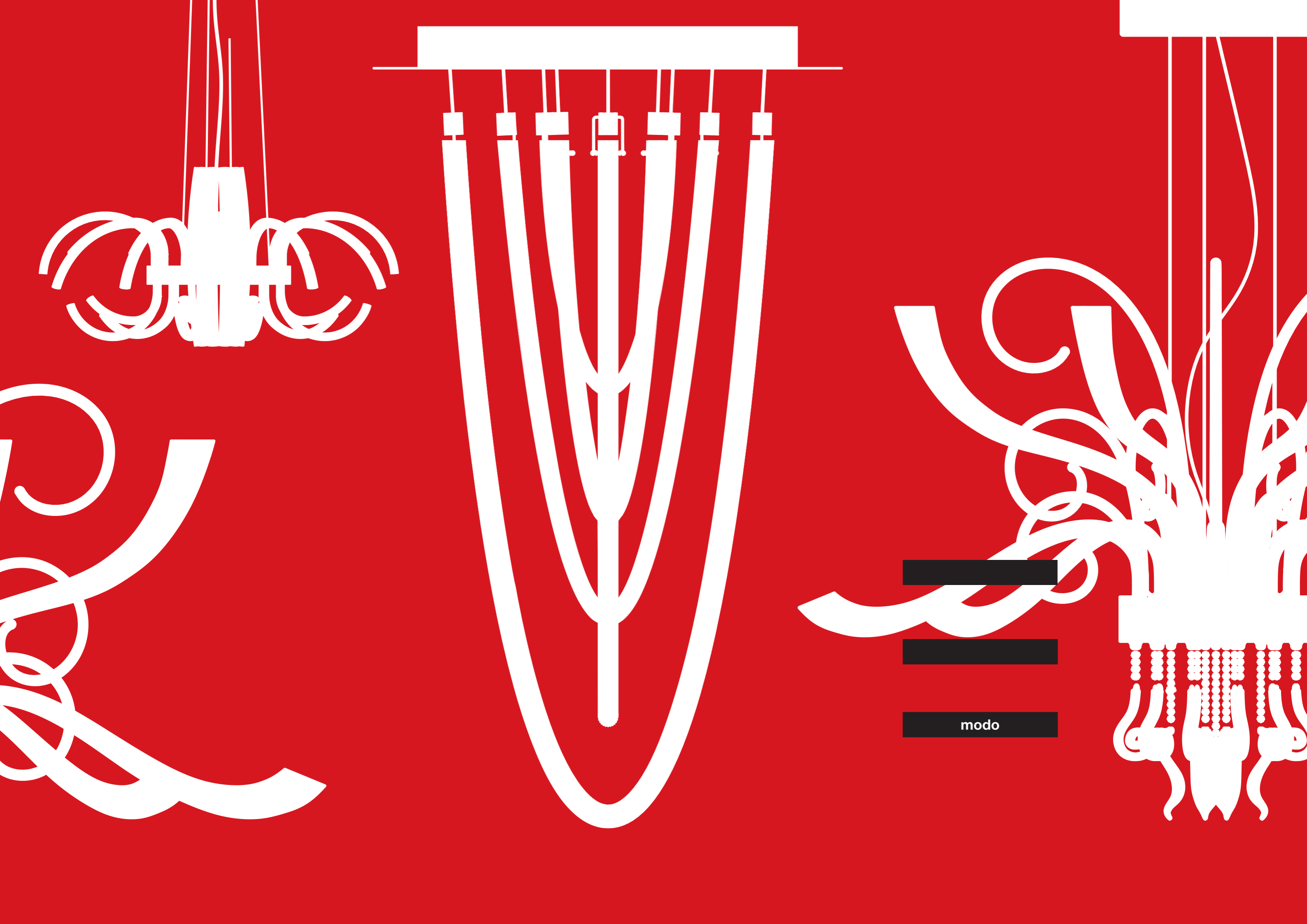

modo

Acqualuce, a captivating design with underwater overtones, as conceived by Diego Chilo, its creator. The pendant light reflects the inspiration of the almost infinitesimal sparks of light and color that emerge from a water fountain streaming in the sunlight. The LED-illuminated, hand-blown elements (the longest is 43 1/4") in transparent, silk, amber or multi-color. The structure is available in polished chrome or white lacquer.

ACQUALUCE S

Colors CR ○ ● ●+○+●+CR+●

LED 18 x 2.4W x 3000K 2600lm

LED 10 x 2.4W 3000K 1630lm

Certifications 

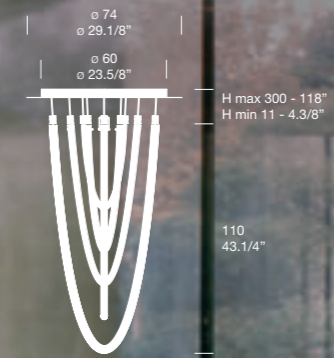

ACQUALUCE

DESIGN / DIEGO CHILO



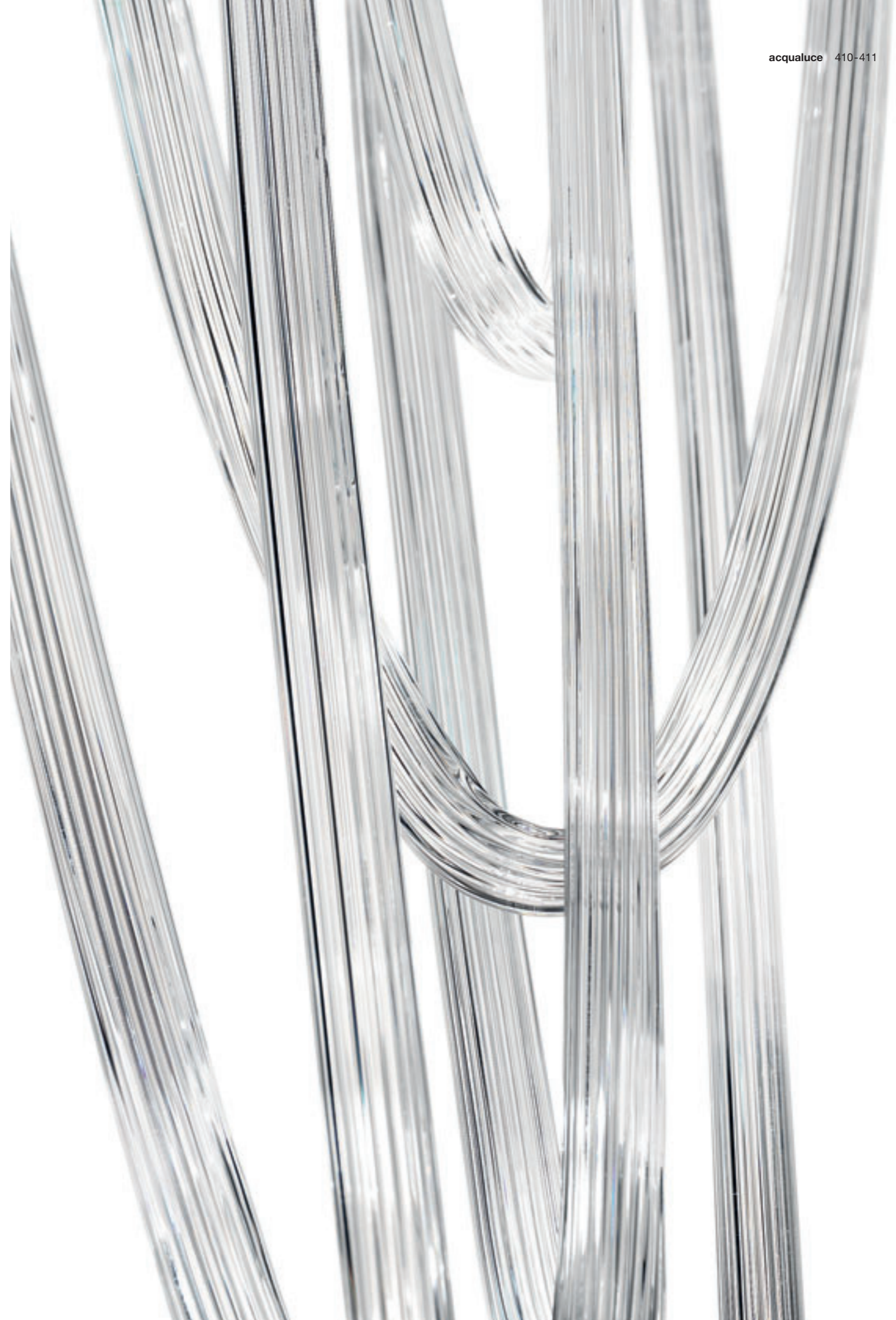

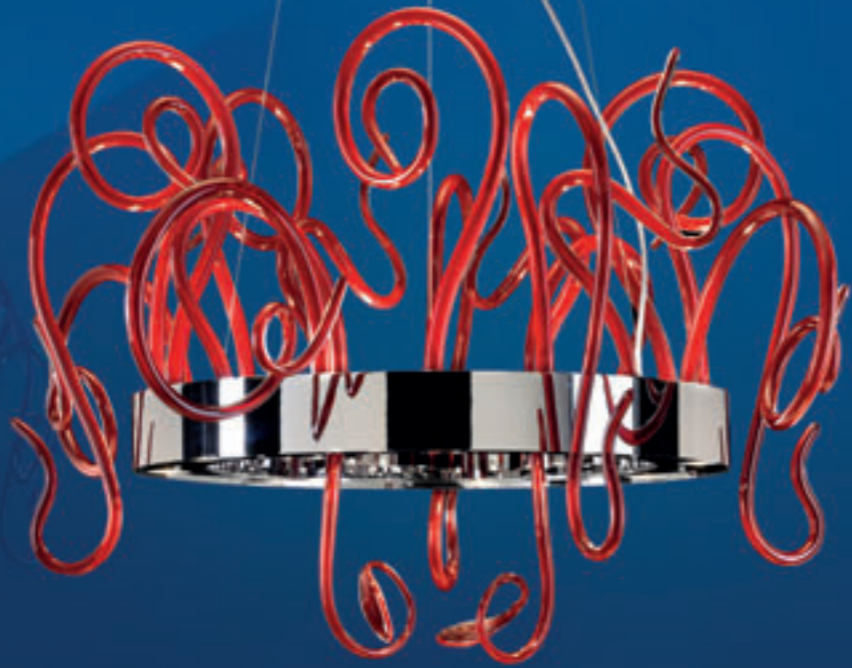

This unique and creative pendant design consists of hand blown curly tentacles suspended from the base in the ceiling with a polished chrome structure. The pendant is available in three sizes. Glass options include: crystal and red. Double switching available. Companion wall design as well as other pendants also available.

ASPID S65

Colors

● CR

max 8 x 35W GU10 (Up-Light)



max 8 x 35W GU10 (Down-Light)



Double switch

Certifications

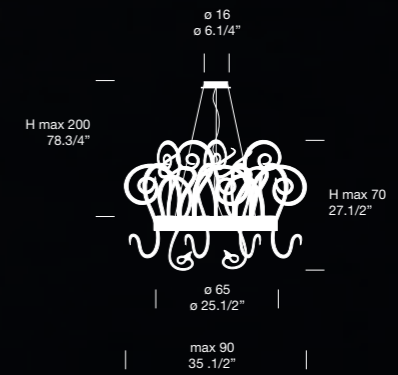

ASPID

DESIGN / DANILO DE ROSSI





This unique and creative pendant design consists of hand blown curly tentacles suspended from the base in the ceiling with a polished chrome structure. The pendant is available in three sizes. Glass options include: crystal and red. Double switching available. Companion wall design as well as other pendants also available.

ASPID

DESIGN / **DANILO DE ROSSI**

ASPID S35

Colors ● CR

max 4 x 35W GU10 (Up-Light)

+
max 4 x 35W GU10 (Down-Light)

Certifications

ASPID S95

Colors ● CR

max 8 x 35W GU10 (Up-Light)

+
max 8 x 35W GU10 (Down-Light)

Certifications

ASPID S35

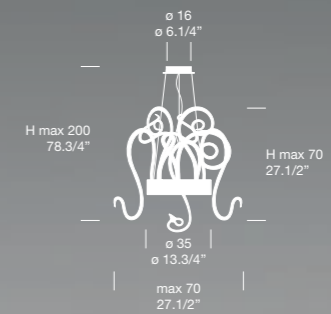

ASPID S95

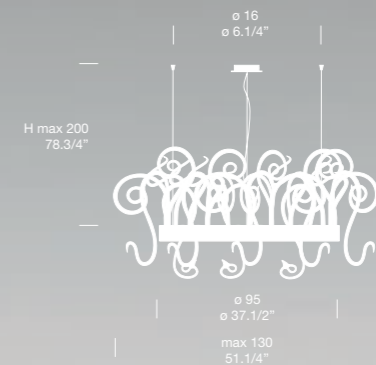



ASPID

DESIGN / **DANILO DE ROSSI**

ASPID P35

Colors

● CR

max 2 x 60W G9



max 3 x 35W GU10



Certifications



Decorative wall sconce consisting of hand blown curly glass mounted on a polished chrome structure. Available in : crystal and red. Companion pendant designs also available.





ATELIER

DESIGN / ARCHIRIVOLTO

This unique and attractive ceiling light consists of a hand blown and hand crafted glass diffuser. The shade is supported to the ceiling by the chrome plated structure. The combination of transparent crystal glass and the chrome metal structure creates perfect harmony. Companion wall and pendant designs also available.

ATELIER PL 32

Color

CR

max 3 x 60W E26



Certifications





ATELIER P

Color

CR

max 1 x 100W R7s (long)

Certifications

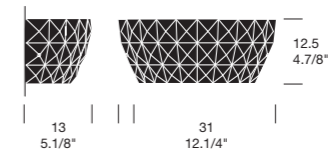

ATELIER

DESIGN / ARCHIRIVOLTO

This original and effective wall design is part of the Atelier collection. A chrome plated frame, mounted on the wall, supports the single lamp inside a wide, crystal-cut, handmade blown glass diffuser. Companion ceiling and pendant designs also available.

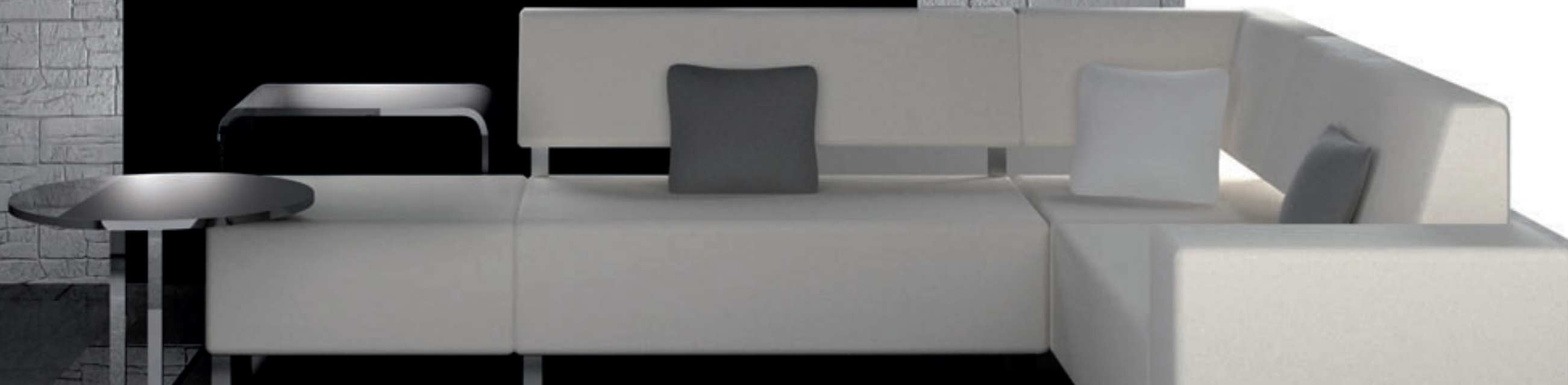



Elegant bowl of crystal displays the most radiant sparkling illumination, shown in the Atelier S Pendant. Atelier features carefully cut crystal which hangs gracefully in luxurious fashion. Companion ceiling and wall designs also available.

ATELIER S

Color

CR

max 1 x 75W E26



max 1 x 150W E26 halostar



Certifications

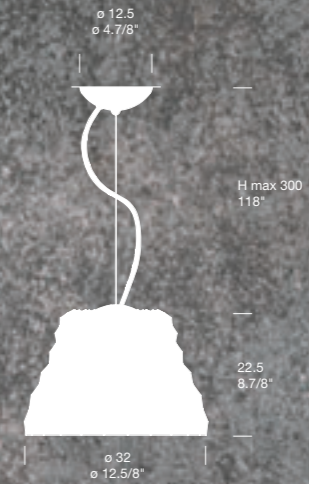

ATELIER

DESIGN / ARCHIRIVOLTO





This classic pendant fixture features a ribbed handmade blown glass diffuser and attaches to a metal structure available in either chrome or gold to match the glass color of either crystal or amber.

ATHENA

DESIGN / CREPAX E ZANON

ATHENA S1

Colors

● CR

max 1 x 60W E12



Certifications

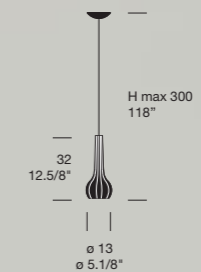



BELZEBÙ L18

Colors



max 18 x 60W E12



Certifications

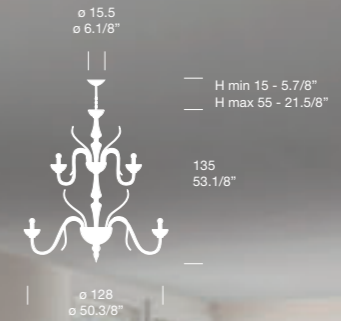

BELZEBÙ

DESIGN / UFFICIO STILE

This chandelier is bold and stylist. It consists of eighteen arms in two tiers, made of handmade blown glass suspended by a hidden polished chrome structure. Available in the following colors: fume', black and milky white. Companion wall as well as smaller size chandelier also available. Fixture weight exceeds standard junction box limits. Additional support is required.



This chandelier is bold and stylist entirely handmade blown glass arms and bowls suspended by a hidden polished chrome structure. Available in the following colors: fume', black and milky white. Companion wall sconce also available.

BELZEBÙ L6

Colors ● ○ ●

max 6 x 60W E12

Certifications

BELZEBÙ P2

Colors ● ○ ●

max 2 x 60W E12

Certifications

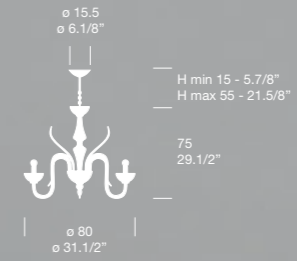

This chic and contemporary wall sconce consists of handmade blown glass arms and glass bowl which secures to the wall by a chrome structure. Available in the following colors: fume', black and milky white. Companion chandeliers in two sizes also available.

BELZEBÙ
DESIGN / UFFICIO STILE





Carlo Nason the creator of the Bolero collection modified the traditional chandelier to create a more playful shape and modern elegance.. The entire chandelier consists of hand-blown glass elements which harmoniously joins a chrome metal structure. The nine small glass bowls contains the light source. Glass color available in either white, crystal or fume'. Companion wall , ceiling and pendant designs also available.

BOLERO L9

Colors GR

max 9 x 60W G9 

max 6 x 20W G4 12V 

Certifications   

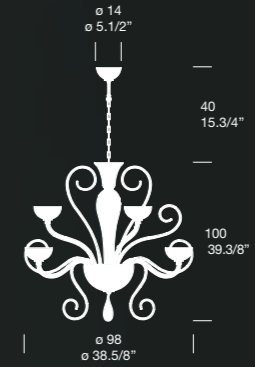

BOLERO

DESIGN / CARLO NASON





BOLERO

DESIGN / CARLO NASON



BOLERO P2

Colors



max 2 x 60W G9



Certifications

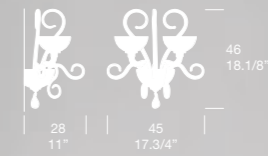
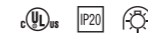

Carlo Nason the creator of the Bolero collection modified the traditional chandelier to create a more playful shape and modern elegance. This curvaceous, modern wall sconce consists of hand-blown glass elements available in either white, crystal or fumé. Companion wall, ceiling and pendant designs also available.



Carlo Nason the creator of the Bolero collection modified the traditional chandelier to create a more playful shape and modern elegance. This graceful and stylish semi-flush ceiling light consists of a crystal clear dome of handmade blown glass, mounted on the chrome plated base on the ceiling, inside which sit the four lamps. A number of elegant branches curve out of the dome. Glass available in either white, crystal or fumé. Companion wall, and pendant designs also available.

BOLERO

DESIGN / CARLO NASON

BOLERO PL75

Colors CR

max 4 x 60W E12 

Certifications  



Carlo Nason the creator of the Bolero collection modified the traditional chandelier to create a more playful shape and modern elegance.. The entire chandelier consists of hand-blown glass elements which harmoniously joins a chrome metal structure. Glass color available in either white, crystal or fumé. Companion wall , ceiling and pendant designs also available.

BOLERO
DESIGN / CARLO NASON



BOLERO L6	
Colors	<input type="radio"/> <input checked="" type="radio"/> CR
max 6 x 60W G9	
max 3 x 20W G4 12V	
Certifications	
BOLERO L3	
Colors	<input type="radio"/> <input checked="" type="radio"/> CR
max 3 x 60W G9	
Certifications	

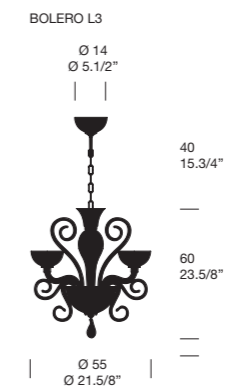
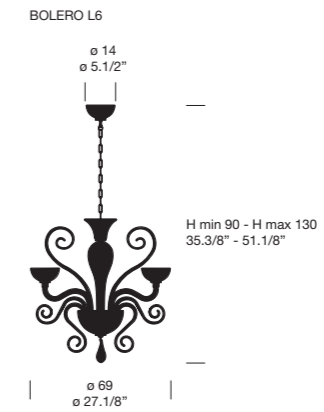



BOLERO S50

Colors



max 3 x 60W G9



Certifications

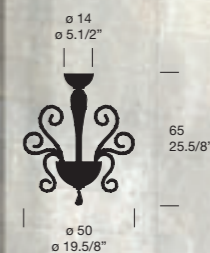

BOLERO

DESIGN / CARLO NASON

Carlo Nason the creator of the Bolero collection modified the traditional chandelier to create a more playful shape and modern elegance. The entire chandelier consists of hand-blown glass elements which harmoniously joins a chrome metal structure. Glass color available in either white, crystal or fumé. Companion wall , ceiling and pendant designs also available.



CHARME

DESIGN / MARINA TOSCANO

This elegant and graceful wall light features curved silkscreened glass overlain with a bass relief in either white, gold or platinum delicately accented by dangling crystals. White lacquered metal frame supports the diffuser. Companion pendant and ceiling designs also available.



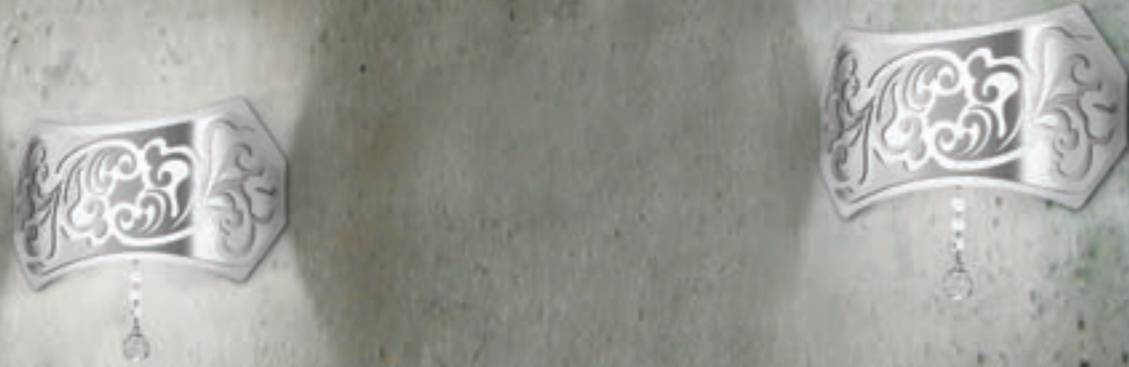

CHARME P

Colors



max 1 x 150W R7s (long)



Certifications



CHARME

DESIGN / MARINA TOSCANO

This elegant and graceful wall light features curved silkscreened glass overlain with a bass relief in either white, gold or platinum delicately accented by dangling crystals. White lacquered metal frame supports the diffuser. Companion pendant and ceiling designs also available.

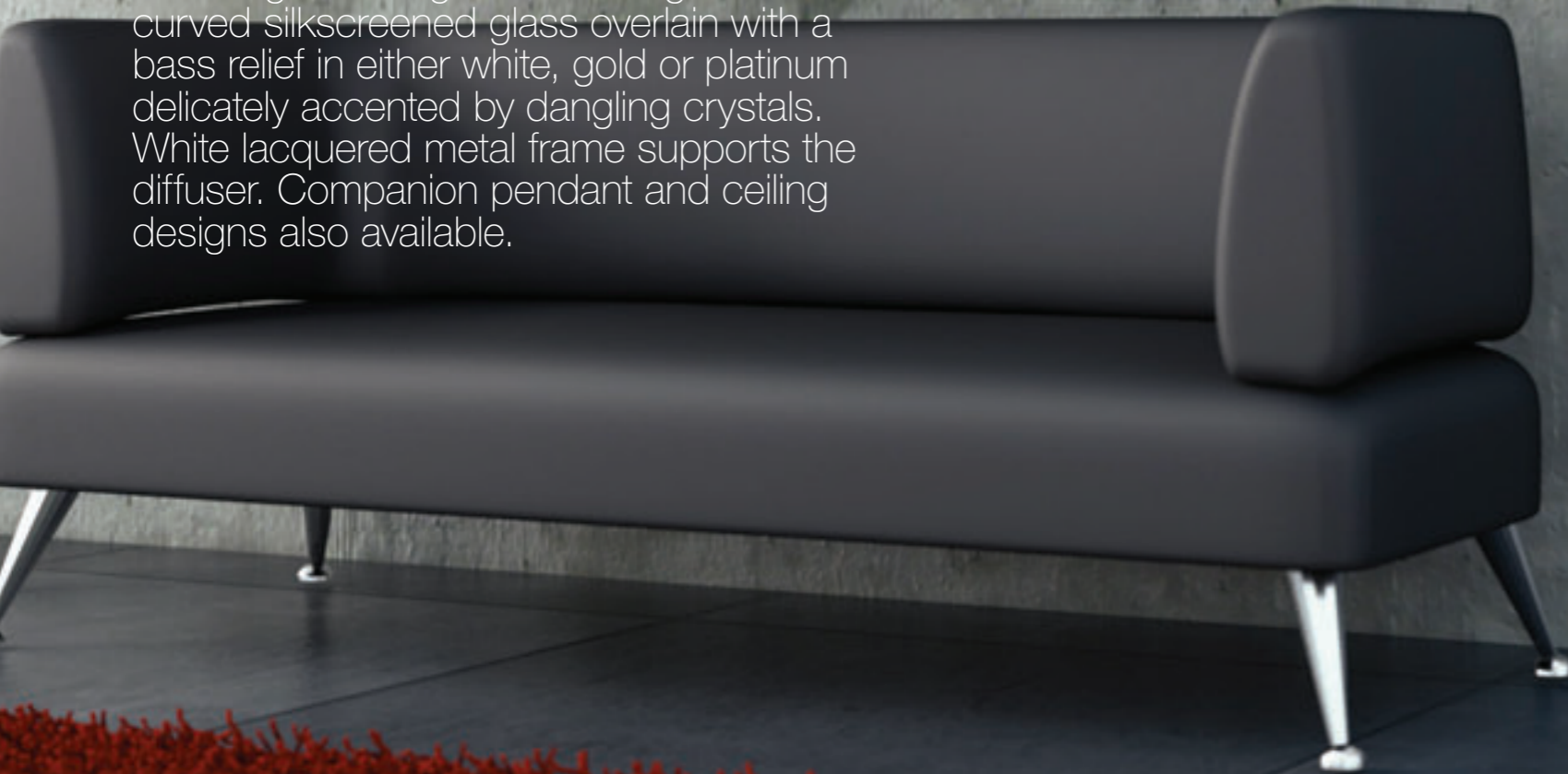

This elegant and attractive pendant fixture features a silkscreened glass shade overlain with a bass relief in either white, gold or platinum delicately accented by dangling crystals. The glass diffuser is supported by a chrome plated metal structure. Companion ceiling and wall designs also available.

CHARME S

Colors



max 1 x 75W E26



max 1 x 26W G24 q-3



Certifications

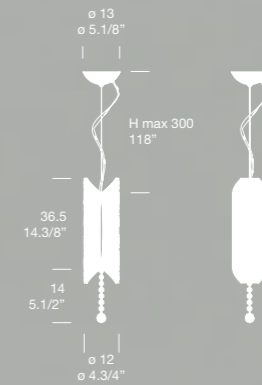

CHARME

DESIGN / MARINA TOSCANO





CHARME P-PL 35	
Colors	
max 4 x 40W G9	
Certifications	
CHARME P-PL 35	
max 1 x 22W 2GX13 T5	
Certifications	
CHARME P-PL 50	
max 4 x 40W G9	
Certifications	
CHARME P-PL 50	
max 1 x 22W + 1 x 40W 2GX13 T5	
Certifications	

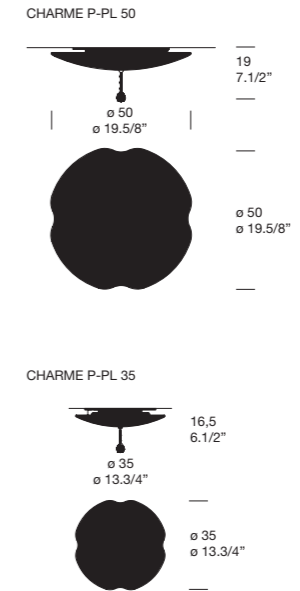

CHARME

DESIGN / MARINA TOSCANO

This graceful and attractive wall/ceiling fixture features a silkscreened glass shade overlain with a bass relief in either white, gold or platinum delicately accented by dangling crystals. White lacquered metal frame supports the diffuser. Companion pendant and wall designs also available.





Couture L8 Chandelier is made entirely out of hand-blown glass in the intricately detailed Ca' Rezzonico" style. The eight arms look like segmented plant stems and the crystal details add to the 'fountain-like' appearance of this beautifully styled chandelier. Available in milky white or glossy black with crystal details.

COUTURE L8

Colors

max 8 x 60W E12

Certifications

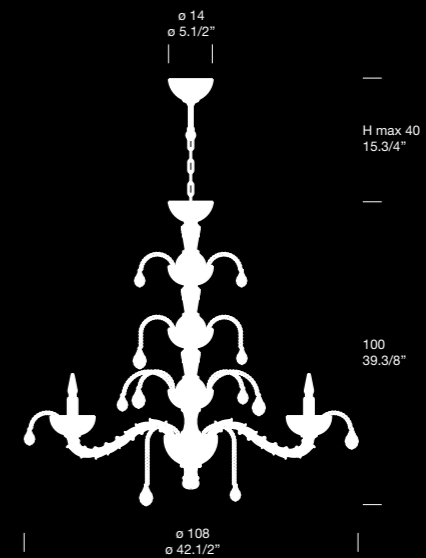

COUTURE

DESIGN / MASSIMO TONETTO





Couture P2 Wall sconce features a hand-blown glass base with segmented curves and other details done in the classic "Ca' Rezzonico" style. Unique curves of handmade crystal add distinctive sparkling appeal. Available in black or white glass with decoration in crystal. Metal structure: polished chrome. "

COUTURE P2

Colors



max 2 x 60W E12



Certifications

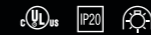

COUTURE

DESIGN / MASSIMO TONETTO





This classic chandelier is an example of true craftsmanship. Intricate yet sleek glasswork comprises the unique frame of the Danieli chandelier from the central metal and hand made glass bowl, cleanly curving arms culminate bowl-shaped light holders. Available in crystal glass with polished chrome structure. Companion wall sconce as well as a large size chandelier also available.

DANIELI L12

Color CR

max 12 x 60W E12 

Certifications 

DANIELI L6

Color CR

max 6 x 60W E12 

Certifications 

DANIELI L12

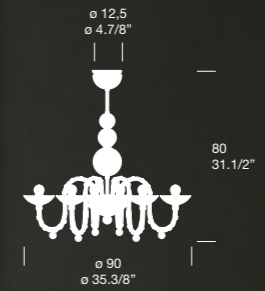

DANIELI L6

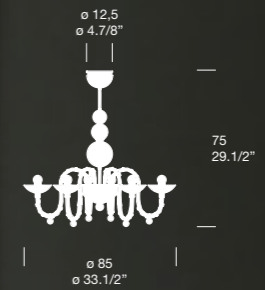

DANIELI
DESIGN / UFFICIO STILE





DANIELI
DESIGN / UFFICIO STILE

The intricate design of Danieli P 2 Wall Sconce can actually be broken down into three basic shapes. There are three bowls of handmade blown glass connected by two S-curves and accented by five spheres (two of which are actually the gleaming bulbs). Available in crystal glass with polished chrome structure. Companion chandeliers in two sizes also available.

DANIELI P2	
Color	CR
max 2 x 60W E12	
Certifications	





DIAMANTE

DESIGN / ARCHIVIO STORICO

DIAMANTE P

Color	CR
2 x 75W E26	
2 x 75W-E26	
1 x max 20W E26 CFL	

Certifications

DIAMANTE PL

Color	CR
4 x 60W E12	
1 x 23W-GU24	

Certifications



DIAMANTE PL

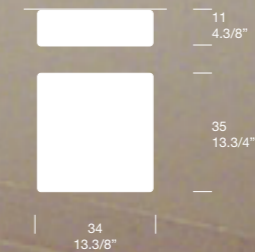

DIAMANTE P

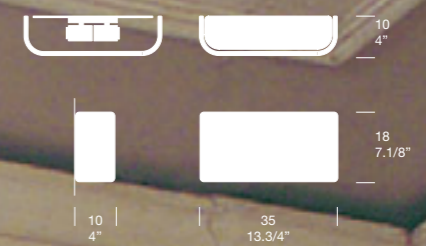

The name comes from the sparkling diamond pattern around the entire surface of the curved clear cast glass shade. The White lacquered interior metal base enhances the bright glow as chromed exterior metal details add to the shade's overall shimmer.



DRACENA

DESIGN / DIEGO CHILO

This dramatic and Gothic pendant design fills a space with light and color. Available in two sizes it lends a theatrical air to any setting. Made of hand-blown glass with a polished chrome structure. This design is available in silk white, amber and red. Companion wall sconce as well as a large scale pendant also available.

Dracena S60	
Colors	
max 4 x 75W G9	
+	
max 1 x 100W E26 PAR30S	
1 x 22W 2Gx13 FC9T5	
+	
max 1 x 100W E26 PAR30S	
Double switch	
Certifications	

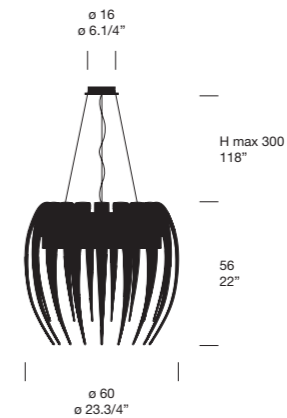

This dramatic and Gothic pendant design fills a space with light and color. Available in two sizes it lends a theatrical air to any setting. Made of hand-blown glass with a polished chrome structure. This design is available in silk white, amber and red. Companion wall sconce as well as a small scale pendant also available.



DRACENA S75

Colors



1 x 55W 2Gx13 T5C



max 4 x 60W G9



max 1 x 100W E26 PAR30S



Double switch

Certifications

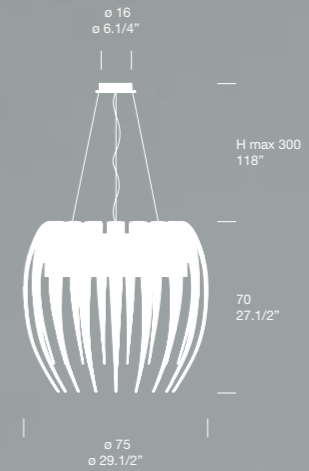

DRACENA

DESIGN / DIEGO CHILO



DRACENA P60

Colors



max 3 x 60W G9



max 1 x 50W GU10



Double switch

2 x 26W G24q-3



Certifications



60
23.3/4"



30
11.3/4"

DRACENA

DESIGN / DIEGO CHILO

This dramatic and Gothic wall design fills a space with light and color. Made of hand-blown glass with a polished chrome structure. This design is available in silk white, amber and red. Double switching is available for the halogen version. Companion pendant design in two sizes also available.





ELYSÉE PL 60

Colors

CR+ ● CR

max 4 x 50W GU10



Certifications

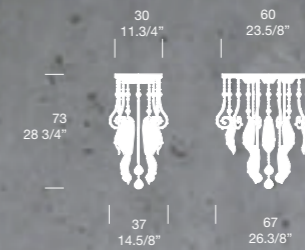

ELYSÉE

DESIGN / MARINA TOSCANO

A glittering cascade of cut crystals enhances a classic and modern ambiance with the elegance of a timeless light. Elysee PL60 is a ceiling design available in 2 sizes. Its structure is made of clear coated metal. Glass is available in clear crystal or clear crystal accented with silver leaf. Companion pendant design is also available.





ELYSÉE

DESIGN / MARINA TOSCANO

A glittering cascade of cut crystals enhances a classic and modern ambiance with the elegance of a timeless light. Elysée PL100 is a ceiling design available in two sizes. Its structure is made from clear coated metal. Glass is available either in clear crystal or clear crystal accented with silver leaf. Companion pendant design is also available.

ELYSÉE PL 100

Colors

CR+ ● CR

max 6 x 50W GU10



Certifications





ELYSÉE L18

Color CR

LED 60W 3000K 4000lm

LED 11W 3000K 900lm

Double switch

Certifications IP20

ELYSÉE L12

Color CR

LED 40W 3000K 2700lm

LED 7.5W 3000K 600lm

Double switch

Certifications IP20

ELYSÉE L18

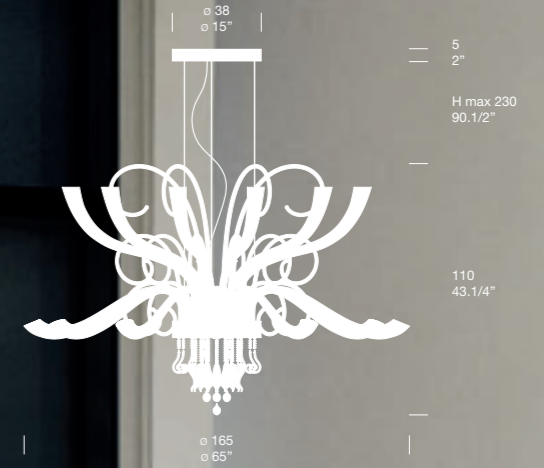

ELYSÉE L12

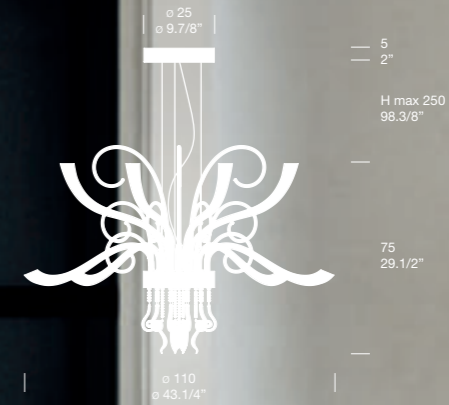

ELYSÉE







DESIGN / MARINA TOSCANO

Elysée evokes the traditional style of a Murano chandelier, but with a modern twist. Composed of translucent, hand-blown glass, its sculptural, LED-illuminated arms and central body set it apart from others in the category. Jewel-like pendants made from hand-crafted glass fall from Elysée's polished steel and chrome-plated metal structure. This striking chandelier is available in two sizes and can be double switched.





ETHER
DESIGN / PATRICK JOUIN

ETHER 150 S	
Color	CR
max 4 x 75W G53	
Version with LED max 4 x 75W G53	
max 1 x 5W multi color high power LED + remote control	
Certifications	  

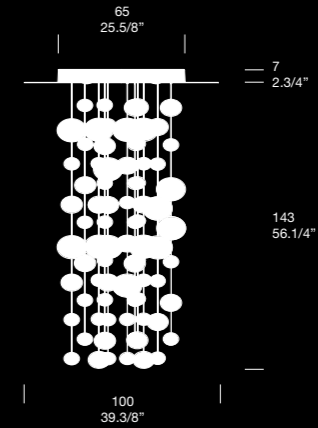

This magnificent , large scale pendant is composed of many glass bubbles. Each glass piece is blown, dimpled and given its unique shape that ultimately form the fixture overall beauty. Metal structure available in polished chrome. Available in three sizes and two light sources. Numerous custom options and configurations are available upon request.

This pendant fixture is composed of many glass bubbles. Each glass piece is blown, dimpled and given its unique shape that ultimately form the fixture overall beauty. Metal structure available in polished chrome. Available in three sizes and two light sources. Numerous custom options and configurations are available upon request.



ETHER
DESIGN / PATRICK JOUIN

ETHER S

Color CR

max 5 x 35W GU5,3

Certifications 

ETHER 90 S

Color CR

max 4 x 75W G5,3

version with LED max 4 x 75W G53 

max 1 x 5W multi color high power LED + remote control 

Certifications 

ETHER S

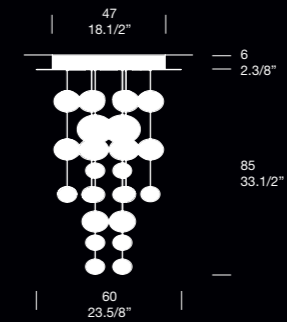

ETHER 90 S

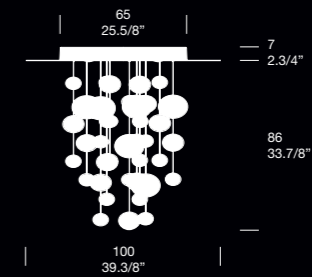





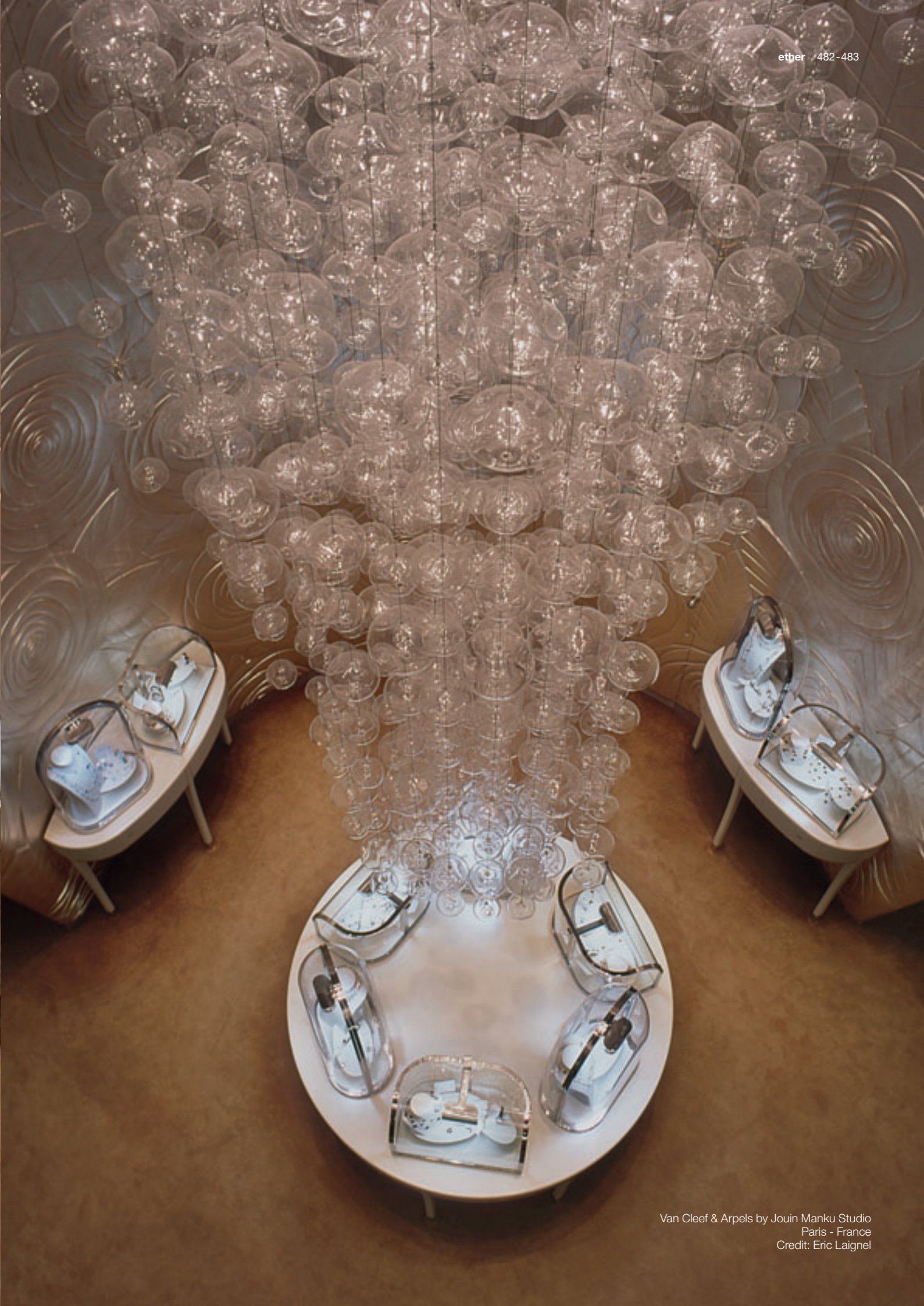



Bodegas Alion of Peñafiel
Valladolid - Spain
Credit: Fernando Manteca



Bodegas Alion of Peñafiel
Valladolid - Spain
Credit: Fernando Manteca



FAIRY

DESIGN / R. TOSO, N. MASSARI & ASSOCIATES WITH G. TOSO



FAIRY S/S	
Color	CR
max 1 x 35W 12V GU4	
Certifications	
LED OPTION AVAILABLE	

The new dramatic Fairy collection includes pendant fixtures in three shapes – “C” cylinder, “G” geoids and “S” spheres. The sparkling glass is made from borosilicate crystal with a ribbed inner tube that encompasses a halogen light source. Available with optional swag mount and supplied with dimmable transformer in ceiling canopy. All pendant versions are available in a broad range of configurations, including a round canopy for one, two, three, five, ten up to 24 lights in one canopy.

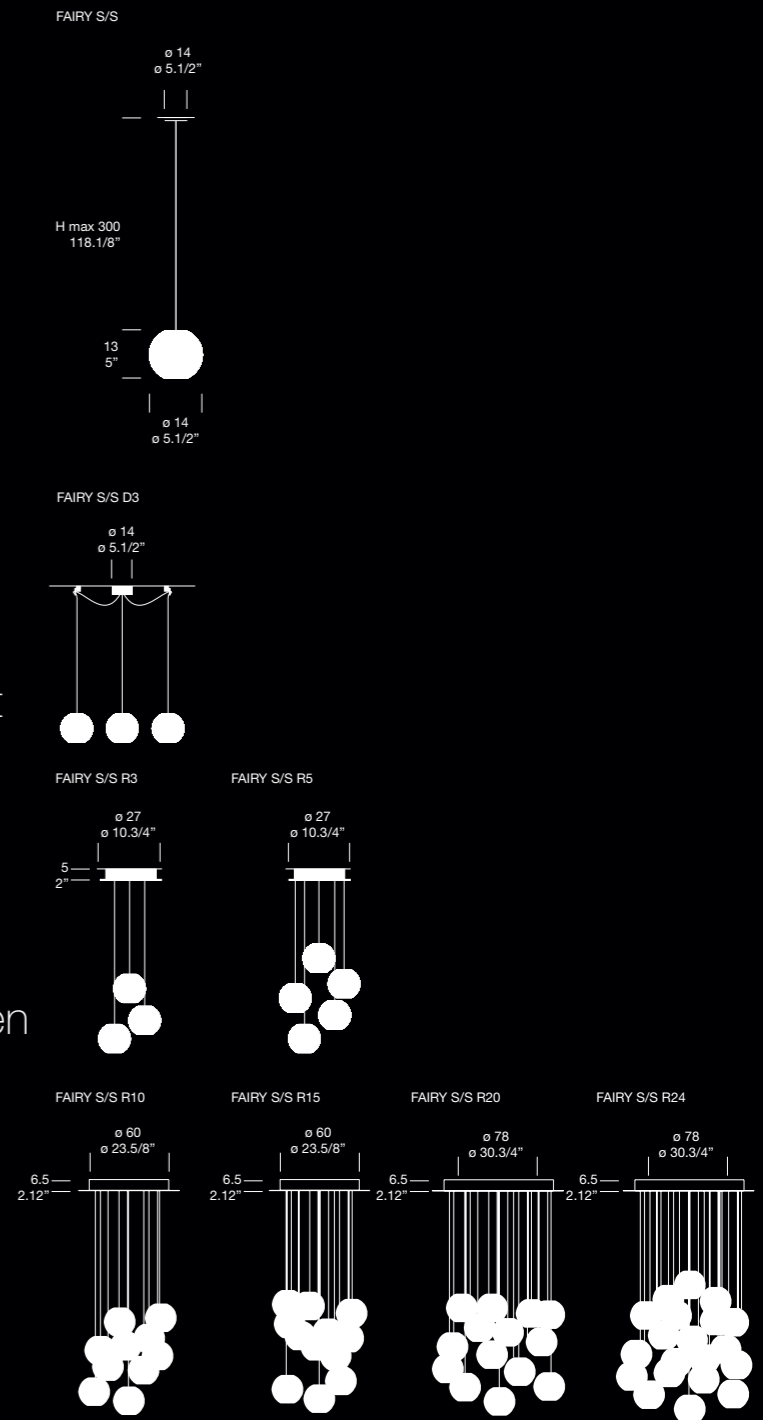



The new dramatic Fairy collection includes pendant fixtures in three shapes – “C” cylinder, “G” geoids and “S” spheres. The sparkling glass is made from borosilicate crystal with a ribbed inner tube that encompasses a halogen light source. Available with optional swag mount and supplied with dimmable transformer in ceiling canopy. All pendant versions are available in a broad range of configurations, including a round canopy for one, two, three, five, ten up to 24 lights in one canopy.

FAIRY S/G

Color

CR

max 1 x 35W 12V GU4



Certifications

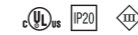

LED OPTION AVAILABLE

FAIRY S/G

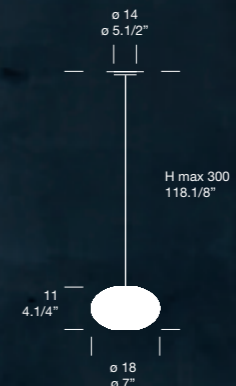

FAIRY S/G D3



FAIRY S/G R3



FAIRY S/G R5

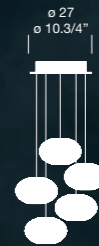

FAIRY S/G R10



FAIRY S/G R15



FAIRY S/G R20







FAIRY S/G R24



FAIRY

DESIGN / R. TOSO, N. MASSARI & ASSOCIATES WITH G. TOSO



FAIRY S/C	
Color	CR
max 1 x 35W 12V GU4	
Certifications	  
LED OPTION AVAILABLE	

FAIRY S/C

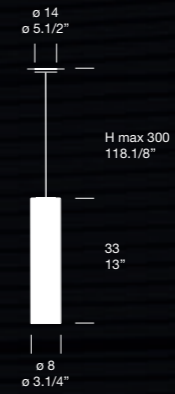

FAIRY S/C D3



FAIRY S/C R3



FAIRY S/C R5



FAIRY S/C R10



FAIRY S/C R15



FAIRY S/C R20



FAIRY S/C R24

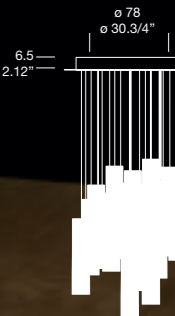

FAIRY

DESIGN / R. TOSO, N. MASSARI & ASSOCIATES WITH G. TOSO

The new dramatic Fairy collection includes pendant fixtures in three shapes –“C” cylinder, “G” geoids and “S” spheres. The sparkling glass is made from borosilicate crystal with a ribbed inner tube that encompasses a halogen light source. Available with optional swag mount and supplied with dimmable transformer in ceiling canopy. All pendant versions are available in a broad range of configurations, including a round canopy for one, two, three, five, ten up to 24 lights in one canopy.



FILUX L

Colors



LED 6 x 13W 3000K 5400lm

Double switch

Certifications

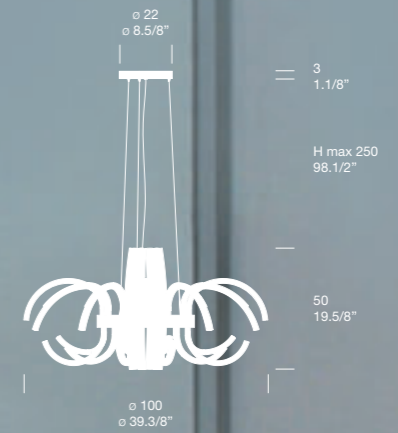

From imaginative designer Diego Chilò, the Filux was inspired by a sea creature. An updated and unconventional take on the classic chandelier, Filux is equipped with advanced LED technology and can be double switched. The hand-blown glass elements are available in smoky-colored glass, red, and a distinctive amber/light blue combination. Its circular frame is composed of polished steel and chrome-plated metal.

FILUX

DESIGN / DIEGO CHILO





GLÒ

DESIGN / DANILO DE ROSSI





GLÒ RECESSED

Colors

1 x 35W-12V-GU5.3 🔊

Certifications UL IP20

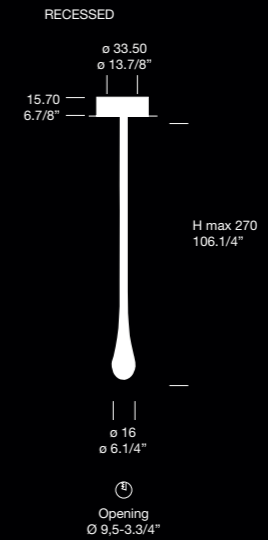
Hand blown in the ancient tradition of Murano glass making, Glò is a sculptural lighting element available in white smoked glass, cobalt blue, red and aquamarine. Optional matching glass hand-poured, free-form puddle to place below the suspended "Drop" for added effect. The mounting structure is available with a recessed housing or pendant. The maximum height of the glass is 270 cm – 106".



Hand blown in the ancient tradition of Murano glass making, Glò is a sculptural lighting element available in white smoked glass, cobalt blue, red and aquamarine. Optional matching glass hand-poured, free-form puddle to place below the suspended "Drop" for added effect. The mounting structure is available with a recessed housing or pendant. The maximum height of the glass is 270 cm – 106".

GLÒ S

Colors



1 x 50W 12V GU5.3



Certifications



LED OPTION AVAILABLE

GLÒ S

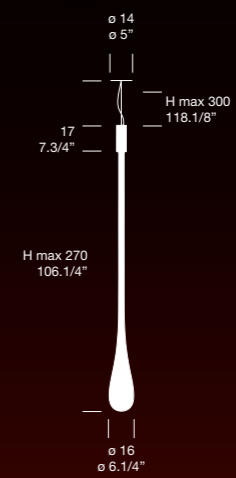

GLÒ

DESIGN / DANILO DE ROSSI

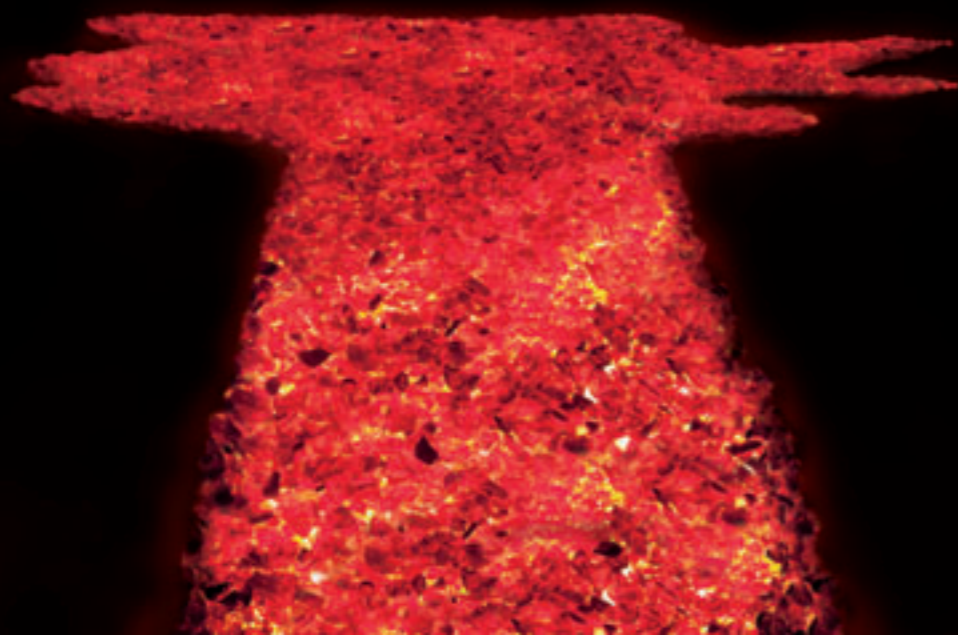



IXI

DESIGN / FILIPPO CAPRIOGLIO

IXI

DESIGN / FILIPPO CAPRIOGLIO





IXI suspension has an industrial aesthetic featuring crystal cylinders of glass with different mirror-chrome finishes and two lengths. Glass finishes include chrome, spiral chrome, transparent and partial chrome. The LED light source in the matte white, square canopy reflect light onto these sparkling tubes. IXI S suspension is a striking stand alone design. Custom configurations are limitless with the IXI glass tubes, whether illuminated or as visual elements.

IXI S	
Color	<input checked="" type="radio"/> + CR
5 x 13W LED 3000K 4500 lm	
Certifications	<input checked="" type="checkbox"/> IP20

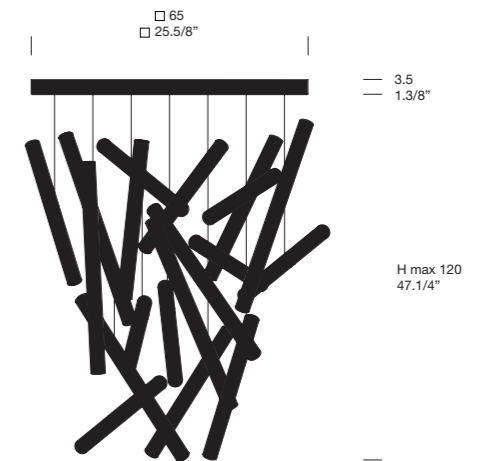

IXI

DESIGN / FILIPPO CAPRIOGLIO





This simple yet sophisticated handmade, cast glass pendant appears leaf or shell-like. White lacquer canopy and details allow for more focus on the curved glass diffuser which is white and clear. The LED light source is shielded in the curved arm of the pendant. Individual units can be supplied with no illumination for clusters of special designs. Larger applications and custom capabilities available upon request.

NIA S (UNILLUMINATED)

Color

NIA S (WITH LED)

Color

3,4W LED 3100K 250 lm

Certifications 

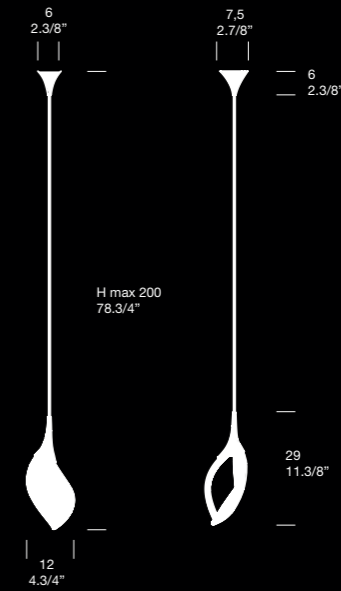

NIA

DESIGN / ROBERTO PAOLI





NIA 6 S

Color



6 x 3,4W LED 3100K 1500 lm

Certifications



Suspended from a white lacquer canopy are the NIA curved glass shapely diffusers of clear and white glass. White details allow for more focus on the curved glass diffuser and the LED light source is shielded in the curved arm of the pendant.

NIA suspensions are available as single units or in three, six and twelve light configurations. CUSTOM COMPOSTIONS AVAILABLE UPON REQUEST.

NIA

DESIGN / ROBERTO PAOLI

Suspended from a white lacquer canopy are the NIA curved glass shapely diffusers of clear and white glass. White details allow for more focus on the curved glass diffuser and the LED light source is shielded in the curved arm of the pendant.

NIA suspensions are available as single units or in three, six and twelve light configurations. CUSTOM COMPOSTIONS AVAILABLE UPON REQUEST.

NIA 12 S

Color



12 x 3,4W LED 3100K 3000 lm

Certifications



NIA

DESIGN / ROBERTO PAOLI

NIA

DESIGN / ROBERTO PAOLI

Suspended from a white lacquer canopy are the NIA curved glass shapely diffusers of clear and white glass. White details allow for more focus on the curved glass diffuser and the LED light source is shielded in the curved arm of the pendant. NIA suspensions are available as single units or in three, six and twelve light configurations. CUSTOM COMPOSITIONS AVAILABLE UPON REQUEST.



NIA 3 S	
Color	<input checked="" type="radio"/>
3 x 3,4W LED 3100K 750 lm	
Certifications	  

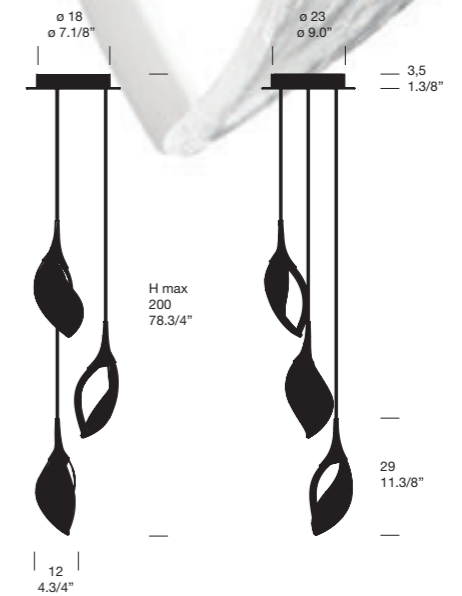



OLANDESE L6

Color

CR

max 6 x 60W E12



Certifications



OLANDESE

DESIGN / DIEGO LAZZARINI

A classical chandelier made in the traditional fashion of Murano glass. The entire chandelier consists of hand-blown glass elements which harmoniously joins a chrome metal structure. The six small glass bowls contains the light source. Available in crystal.



This elegant and artistic chandelier is truly a masterpiece all made of hand-blown glass. At the bottom, the shade is decorated with leaves of cast crystal glass. Available in white or black glass with crystal decoration. Companion wall and ceiling design also available.

ORLEANS L12

Colors



max 12 x 60W E12



Certifications

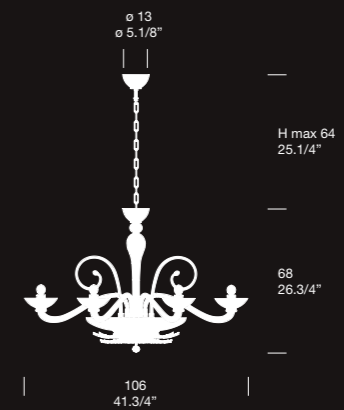

ORLEANS

DESIGN / MARINA TOSCANO



ORLEANS S50	
Colors	<input type="radio"/> <input checked="" type="radio"/>
max 5 x 60W E12	
max 5 x 60W E12 (halostar)	
Certifications	

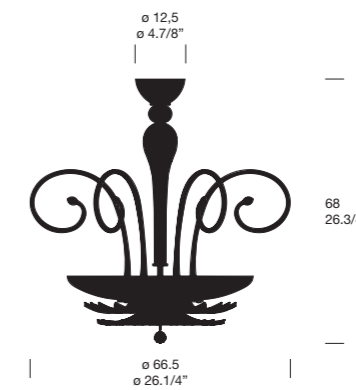

This elegant and artistic chandelier is truly a masterpiece all made of hand-blown glass. At the bottom, the shade is decorated with leaves of cast crystal glass. Available in white or black glass with crystal decoration. Companion wall and ceiling design also available.

ORLEANS

DESIGN / MARINA TOSCANO

ORLEANS

DESIGN / MARINA TOSCANO

This elegant and artistic wall sconce is truly a masterpiece all made of hand-blown glass. At the bottom, the shade is decorated with leaves of cast crystal glass. Available in white or black glass with crystal decoration. Companion ceiling and pendant design also available.

ORLEANS P

Colors



max 1 x 100W R7s (long)



Certifications



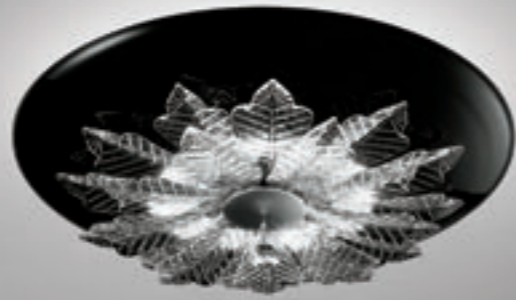

This elegant and artistic ceiling fixture is truly a masterpiece all made of hand-blown glass. At the bottom, the shade is decorated with leaves of cast crystal glass. Available in white or black glass with crystal decoration. Companion wall and pendant designs also available.

ORLEANS PL

Colors



max 5 x 60W E12



max 5 x 60W E12 (halostar)



Certifications

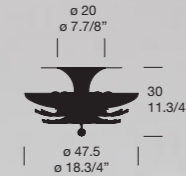

ORLEANS

DESIGN / MARINA TOSCANO





PASCALE PL

Color

CR

max 3 x 60W E12



Certifications

IP20



PASCALE

DESIGN / UFFICIO STILE

Elegant ceiling design in transparent crystal glass creates an exceptionally beautiful light. Its shade is made from curved cast crystal glass and harmonizes perfectly with its chromed metal structure.



REED

DESIGN / PATRICK JOUIN





Taking inspiration from nature, the elegant glass tubes of Reed are like crystal reeds shooting out of the water. These glass elements are highlighted by ribbed, transparent crystal glass. The pendant version is available in two sizes REED 90S and REED 135S. The glass element is suspended with adjustable cable and clear cord. Companion ceiling mounted as well as custom clusters can be configured in an assortment of designs.

REED

DESIGN / PATRICK JOUIN



REED 90 S

Color CR

max 1 x 50W GU10

Certifications

LED VERSION AVAILABLE UPON REQUEST

REED 135 S

Color CR

max 1 x 75W GU10

Certifications

LED VERSION AVAILABLE UPON REQUEST

REED 90 S

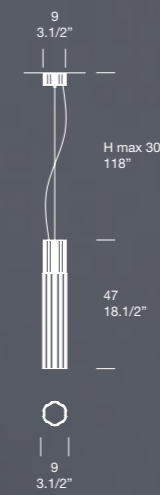

REED 135 S

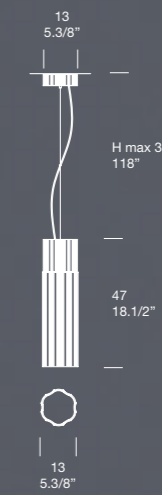



Taking inspiration from nature, the elegant glass tubes of Reed are like crystal reeds shooting out of the water. These glass elements are highlighted by ribbed, transparent crystal glass. The Ceiling mount design is available in three sizes : Reed 90 PL, Reed 135 PL and Reed 180 PL. The glass element is supported by an aluminum nickel painted structure. Companion pendants as well as custom clusters can be configured in an assortment of designs

REED 90 PL

Color CR

max 1 x 50W GU10

Certifications

LED VERSION AVAILABLE UPON REQUEST

REED 135 PL

Color CR

max 1 x 75W GU10

Certifications

LED VERSION AVAILABLE UPON REQUEST

REED 180 PL

Color CR

max 1 x 75W E26 Halopar

Certifications

LED VERSION AVAILABLE UPON REQUEST

REED 90 PL



REED 135 PL

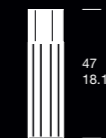

REED 180 PL



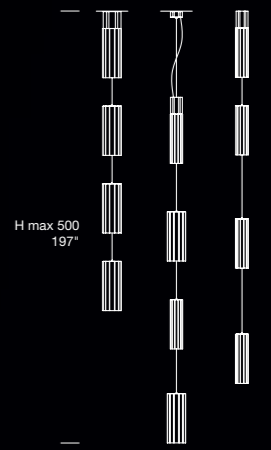

Composition models



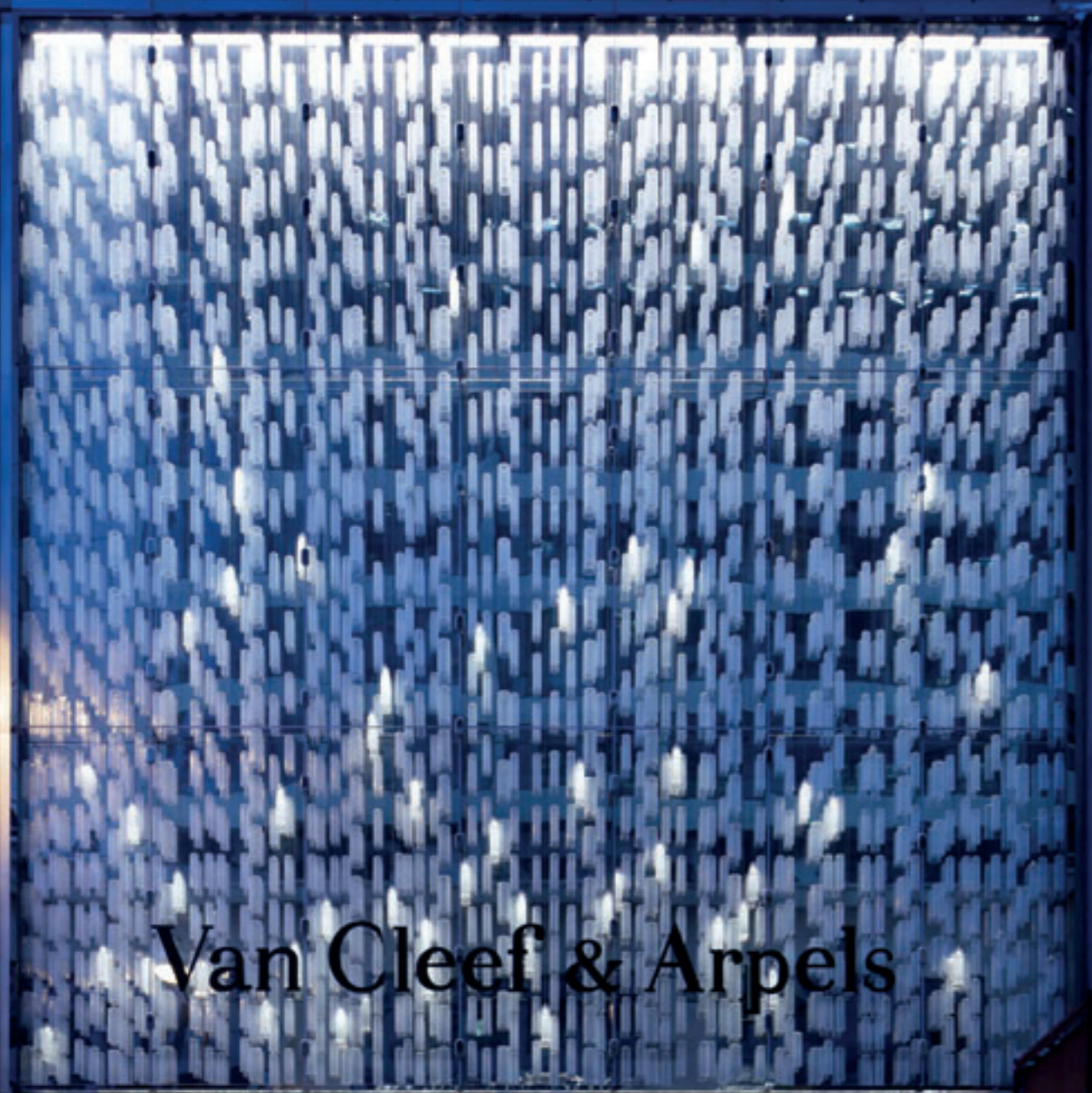

Van Cleef & Arpels

Van Cleef & Arpels

Van Cleef & Arpels

Van Cleef & Arpels by Jouin Manku Studio
Hong Kong - China
Credit: Nakasa & Partners Inc.



Van Cleef & Arpels

Van Cleef & Arpels

Van Cleef & Arpels

Van Cleef & Arpels by Jouin Manku Studio
Hong Kong - China
Credit: Nakasa & Partners Inc.







Restaurant Beefbar, Mexico City - Mexico
Architect: Humbert & Poyet Monte Carlo
www.beefbar.com



Auberge de L'II by Joün Manku Studio
Illhausern - France
credit: Eric Laignel

key to symbols



This marking is used on products for export to the Canadian and USA markets, which guarantees that the product conforms to the safety requirements of those countries



This Marking is used on products for export to the USA market, which guarantees that the products conform to the safety requirements to the USA.



The ETL Listed Mark indicates to distributors, retailers and customers that your product has been tested by Intertek and found in compliance with accepted national standards.



This mark guarantees that the product has passed all the tests established for electrical safety standards by the European Community



Fixture class II. A fixture where protection against electric shock does not rely only on the main insulation but also further safety measures involving double insulation or reinforced insulation



Fixture class III. A fixture where protection against electric shock depends on the very low and safe voltage supply, guaranteeing no higher voltage levels are generated. N.B. a Class III fixture does not necessarily require grounding protection



Index protection. A symbol that identifies the protection index against dust, solid particles or damp entering the fixture



The Americans Disabilities Act



Certifies that a product conforms to EN standards and has been designed and manufactured by companies with an approved UNI EN ISO 9000 quality control system. The ENEC symbol is issued by authorised boards to guarantee the safety and quality of our products for the final customer



Low-energy consumption lamps can be used (fluorescent and/or LED)



These lamps do not require shields.

LEUCOS USA INC.

11 Mayfield Avenue
Edison _ New Jersey 08837
t. 732 225-0010
f. 732 225-0250
info@leucosusa.com
www.leucosusa.com

