



 **Cleoni**[®]
decorative



Szanowni Państwo!

Cleoni to polska marka, której nazwa może dziś stanowić synonim dążenia do odkrywania nowych, interesujących rozwiązań oświetleniowych. Dowodem tego są kolejne nasze kolekcje, które odzwierciedlają wartości dla nas najważniejsze, a mianowicie piękno, innowacyjność i użyteczność. To cechy, które przeplatają się na wszystkich etapach tworzenia naszych lamp i w każdym ich szczególe - począwszy od wyboru materiałów, poprzez projekt formy, a na produkcji kończąc. Wszystko po to, by móc zaoferować Państwu produkty ze wszech miar wyjątkowe i spełniające najwyższe wymagania - zarówno pod względem wykonania, jak i estetyki.

Wiemy, jak niezwykle istotną rolę w funkcjonowaniu człowieka pełni właściwe oświetlenie, a świadomość tego wzrasta w nas nieprzerwanie od 1998 roku, kiedy to powstała nasza firma. Od tego czasu proponujemy naszym klientom coraz lepsze rozwiązania i coraz bardziej innowacyjne lampy. Wykorzystujemy zaawansowane technologie i większość opraw naszej produkcji przystosowujemy do źródeł światła LED. Ze względu na ciągły rozwój technologii LED, zastrzegamy więc sobie prawo do zmiany rodzaju lub konfiguracji źródeł światła, aby zawsze były zgodne z najnowocześniejszymi standardami.

Prezentowane kolekcje są wynikiem naszych ostatnich pomysłów i odkryć, a wszelkie ich modyfikacje i aktualizacje będą publikowane na stronie www.cleoni.pl - bezpośrednio przy produkcji. Dlatego też zachęcamy Państwa do zapoznania się z niniejszym katalogiem oraz stroną internetową i poznanie efektów naszej pracy. Efektów z których jesteśmy prawdziwie dumni.

Miłej lektury!
Zespół Cleoni

Ladies and Gentlemen!

Cleoni is a Polish brand whose name can still be a synonym of striving to discover new and interesting lighting solutions. We prove this by creating collections which reflect the values most important to us, namely: beauty, innovation and stability. These are features that are interwoven through all stages of the creative process and in each detail of the lamps - from the choice of materials, through the designing process, to production. All of this is for the purpose of being able to offer you products which are, by all means, unique, and meet the highest standards of requirement- both in terms of building and aesthetics.

We know how extremely important proper lighting is in human function, and our awareness of this has continued to grow since 1998, when our company was founded. Since that time, we have offered our customers more and more innovative and modern lamps. We use the most advanced technology and we have adjusted most of our luminaires to the LED light sources. Due to the continuous development of LED technology, we reserve the right to change the type or configuration of light sources in order to always comply with the latest standards.

Our current collections are the result of our most recent discoveries and ideas and all the modifications and updates will be available straight away on www.cleoni.pl. Therefore, we encourage you to familiarize yourself with this folder and our website, and to get to know the results of our work. Results we are truly proud of.

We hope you enjoy reading!
The Cleoni Team

Spis treści / Table of contents

| | |
|--|-----------|
| Oprawy z drewna Wooden lamps | 1 - 72 |
| Oprawy z żywicy poliestrowej Lamps made of polyester resin | 73 - 80 |
| Oprawy oświetleniowe loftowe Loft lamps | 81 - 110 |
| Oprawy z metalu Luminaires made of metal | 111 - 188 |
| Oprawy z betonu architektonicznego Luminaires made architectural concrete | 189 - 206 |
| Oprawy z masy gipsowej Plaster lamps | 207 - 282 |
| Oprawy ceramiczne Ceramic lamps | 283 - 308 |
| Tabele kolorów i opisy Tables of colors and descriptions | 309 - 316 |

Oprawy z drewna

Ponadczasowa klasyka

Drewno to materiał absolutnie uniwersalny i niezwykle wręcz elegancki. Swoją naturalnością zachwyca od pokoleń. Pięknie prezentuje się zarówno we wnętrzach klasycznych, jak i w tych nowoczesnych, podkreślając charakter każdego z nich jedynie formą i stylem wykończenia. My oferujemy oprawy drewniane fornirowane lub malowane lakierami. W tym drugim wypadku wykończenie może być matowe bądź błyszczące - o wysokim połysku. Szeroki wybór kształtów sprawia, że każdy odnajdzie wśród nich model dla siebie - niezależnie od tego, czy jest zwolennikiem bardziej czy mniej konwencjonalnych rozwiązań.

Wooden lamps

Timeless classics.

Wood is an incredibly versatile and extremely elegant material. Its natural quality delights for generations. It presents beautifully in both classic and modern interiors, emphasizing the characteristic of each with just its form and style of finish. We offer luminaries made of wood veneer or painted with lacqueres. In the latter case, the finish may be matte or high gloss. Thanks to a wide range of shapes, everyone can find a model to suit each individual need - regardless of whether he prefers more, or less, conventional solutions.

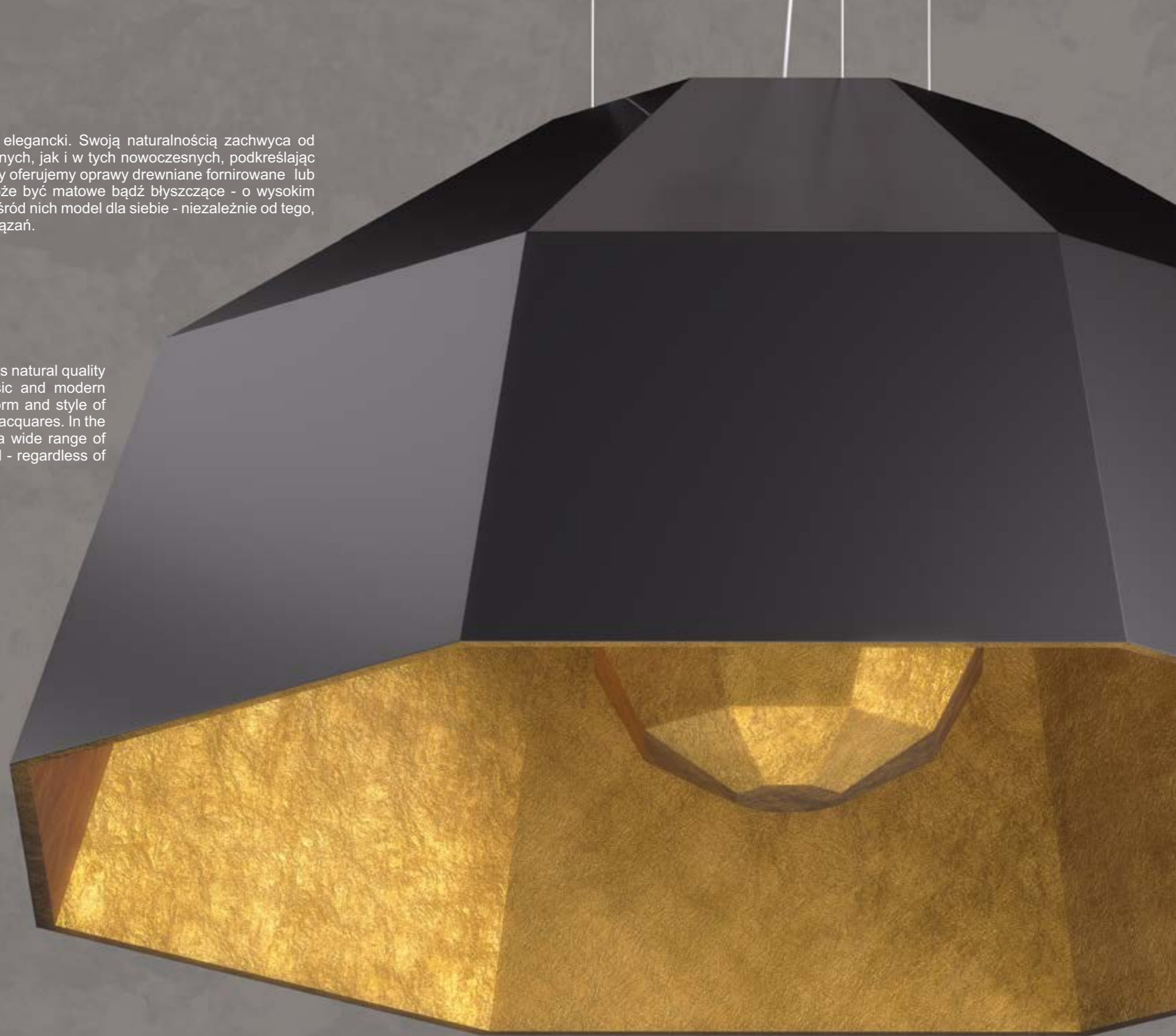



Oprawy fornirowane

color 2 zew.



Oprawy lakierowane

color 9, 11 zew.

Konfiguracje czasz:

Elan A **1235A**/ x / xx / color 2, 9, 11

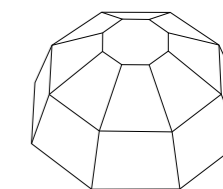
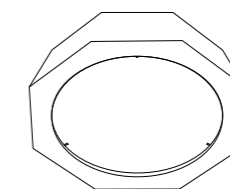

Cortina A **1236A**/ x / xx / color 2, 9, 11

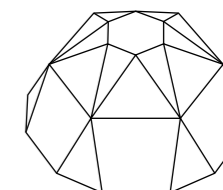
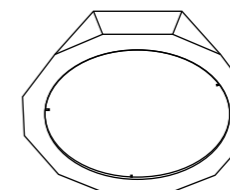

Abakuk A **1255A**/ x / xx / color 2, 9, 11

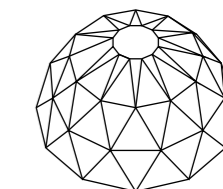
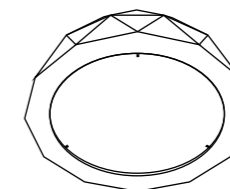

Wielkości czasz: x

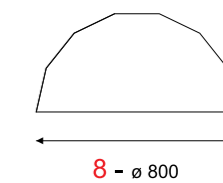
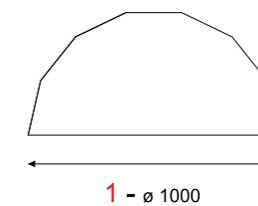

Źródła światła: xx



LED ECO

A - 6x max 23W, 230V, 50Hz

D - 3x 40W, 230V, 50Hz

D8 - 72W, 6998lm, 3000K
4000K

B - 4x max 23W, 230V, 50Hz

E - 3x 22W, 230V, 50Hz

D8 - 72W, 6998lm, 3000K
4000K



Oprawy fornirowane

color 2 zew.

Oprawy lakierowane

color 9, 11 zew.

Konfiguracje czasz:

Elan E **1235E**/ x / xx / color 2, 9, 11

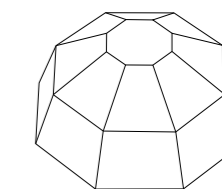
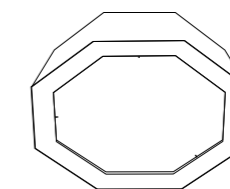

Cortina E **1236E**/ x / xx / color 2, 9, 11

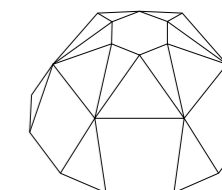
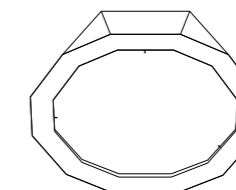

Abakuk E **1255E**/ x / xx / color 2, 9, 11

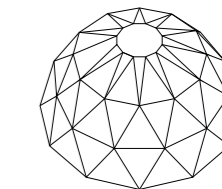
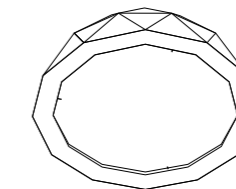

Wielkości czasz: x

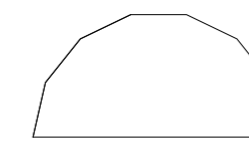

1 - ø 1000

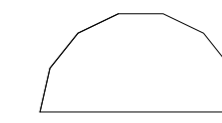

8 - ø 800

Źródła światła: xx



E27



2GX13

LED ECO

A - 6x max 23W, 230V, 50Hz

D - 3x 40W, 230V, 50Hz

D8 - 72W, 6998lm, 3000K
4000K

B - 4x max 23W, 230V, 50Hz

E - 3x 22W, 230V, 50Hz

D8 - 72W, 6998lm, 3000K
4000K



Oprawy fornirowane
color 2 zew.



Oprawy lakierowane
color 9, 11 zew.

Konfiguracje czasz:

Elan B **1235B**/ x / xx / xxx / color 2, 9, 11

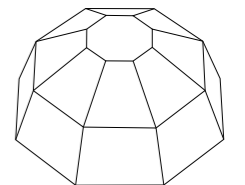
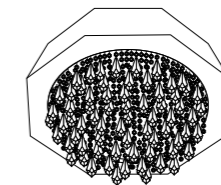

Cortina B **1236B**/ x / xx / xxx / color 2, 9, 11

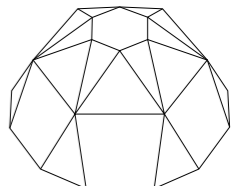
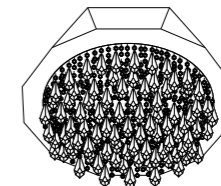

Abakuk B **1255B**/ x / xx / xxx / color 2, 9, 11

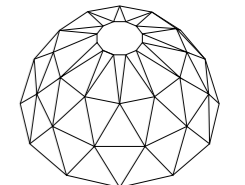
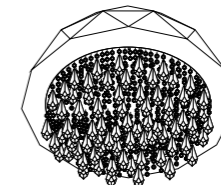

Wielkości czasz: x

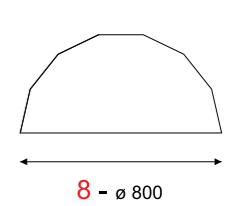
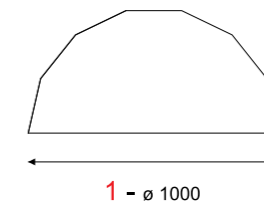

Źródła światła: xx



E27

A - 6x max 23W, 230V, 50Hz

B - 4x max 23W, 230V, 50Hz



2GX13

D - 3x 40W, 230V, 50Hz

E - 3x 22W, 230V, 50Hz

LED **ECO**

D8 - 72W, 6998lm, 3000K
4000K

D8 - 72W, 6998lm, 3000K
4000K

Kryształy: xxx

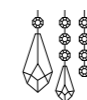

D



M

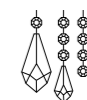

D



M

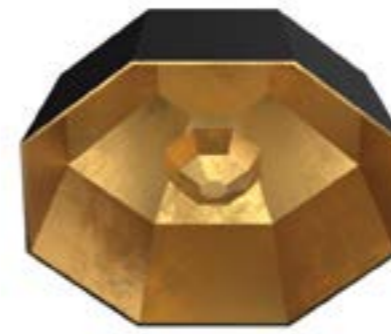

Wewnętrzne wykończenie
w powłokach pozłotniczych

color 10 zew.



Oprawy fornirowane

color 2 zew.



Oprawy lakierowane

color 9, 11 zew.

Konfiguracje czasz:

Elan **1235C** / x / xx / color 10 / color 2, 9, 11

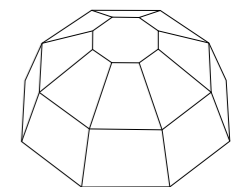
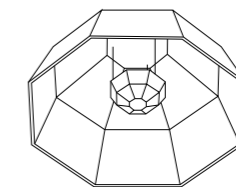

Cortina **1236C** / x / xx / color 10 / color 2, 9, 11

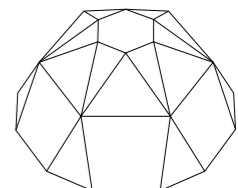
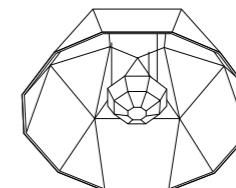

Abakuk **1255C** / x / xx / color 10 / color 2, 9, 11

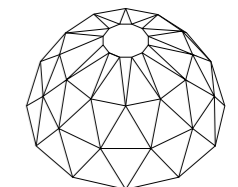
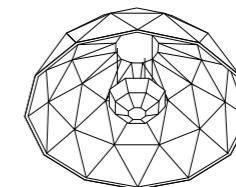

Wielkości czasz: x

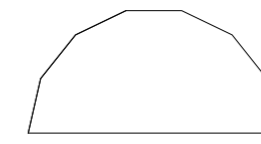

1 - ø 1000

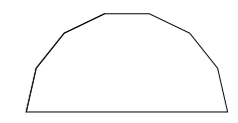

8 - ø 800

Źródła światła: xx



LED ECO

P - 2x max 23W, 230V, 50Hz

L2 - 25W, 2755lm, 3000K
4000K

P - 2x max 23W, 230V, 50Hz

L2 - 25W, 2755lm, 3000K
4000K

Kolor wewnętrzny: color 10
Powłoki pozłotnicze



942 - Schlagmetal
złoty



944 - Schlagmetal
srebrny



945 - Schlagmetal
miedz





Wewnętrzne wykończenie
w powłokach pozłotniczych

color 10 zew.



Oprawy fornirowane

color 2 zew.



Oprawy lakierowane

color 9, 11 zew.

Konfiguracje czasz:

Elan **1235D**/ x / xx / color 10 / color 2, 9, 11

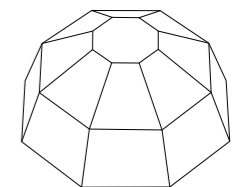
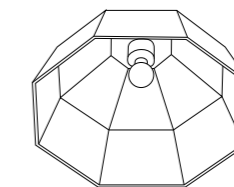

Cortina **1236D**/ x / xx / color 10 / color 2, 9, 11

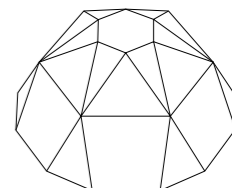
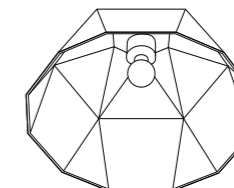

Abakuk **1255D**/ x / xx / color 10 / color 2, 9, 11

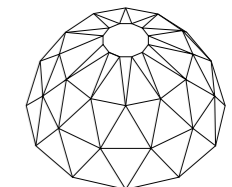
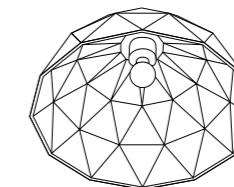

Wielkości czasz: x

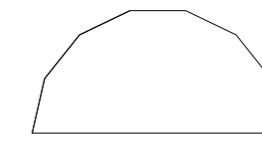

1 - ø 1000

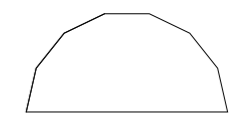

8 - ø 800

Źródła światła: xx



E27



Gu10

E - 1x max 23W, 230V, 50Hz

A - 1x max 40W, 230V, 50Hz

E - 1x max 23W, 230V, 50Hz

A - 1x max 40W, 230V, 50Hz

Kolor wewnętrzny: color 10
Powłoki pozłotnicze



942 - Schlagental
złoty



944 - Schlagental
srebrny



945 - Schlagental
miedz













Taranto





Taranto 1238 symetryczna / symmetric

-   Poliwęglan  2x max 23W, 230V, 50Hz
-   Kryształ duży  2x max 23W, 230V, 50Hz
-   Kryształ mały  2x max 23W, 230V, 50Hz
-   Oprawy dostępne w wersji LED

Index









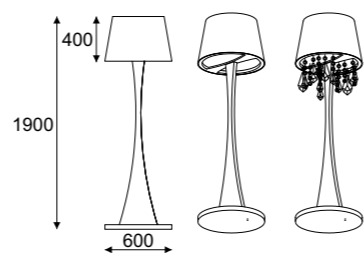

1238D1EP
color 2, 9, 11

1238M1ED
color 2, 9, 11

1238M1EM
color 2, 9, 11



Taranto 1238 stojąca/ floor

-   Poliwęglan  2x max 23W, 230V, 50Hz
-   Kryształ duży  2x max 23W, 230V, 50Hz
-   Kryształ mały  2x max 23W, 230V, 50Hz
-   Oprawy dostępne w wersji LED

Index









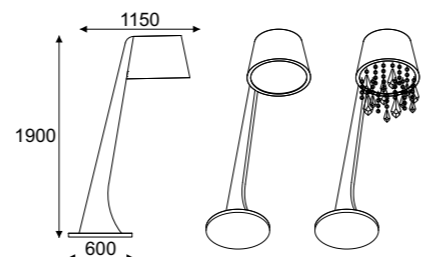

1238B1EP
color 2, 9, 11

1238H1ED
color 2, 9, 11

1238H1EM
color 2, 9, 11



Taranto 1238 wisząca / hanging lamp

-   Poliwęglan  2x max 23W, 230V, 50Hz
-   Kryształ duży  2x max 23W, 230V, 50Hz
-   Kryształ mały  2x max 23W, 230V, 50Hz
-   Oprawy dostępne w wersji LED

Index









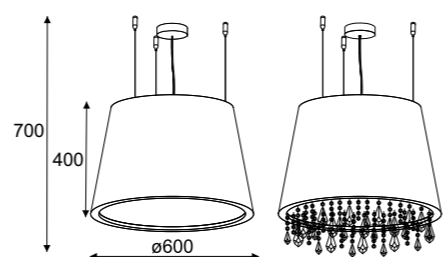

1238C1EP
color 2, 9, 11

1238K1ED
color 2, 9, 11

1238K1EM
color 2, 9, 11



Taranto 1238 asymetryczna / asymmetric

-   Poliwęglan  2x max 23W, 230V, 50Hz
-   Kryształ duży  2x max 23W, 230V, 50Hz
-   Kryształ mały  2x max 23W, 230V, 50Hz
-   Oprawy dostępne w wersji LED

Index

    

1238A1EP
color 2, 9, 11

1238E1ED
color 2, 9, 11

1238E1EM
color 2, 9, 11

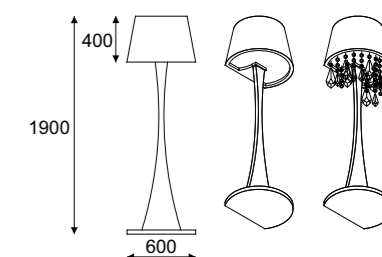

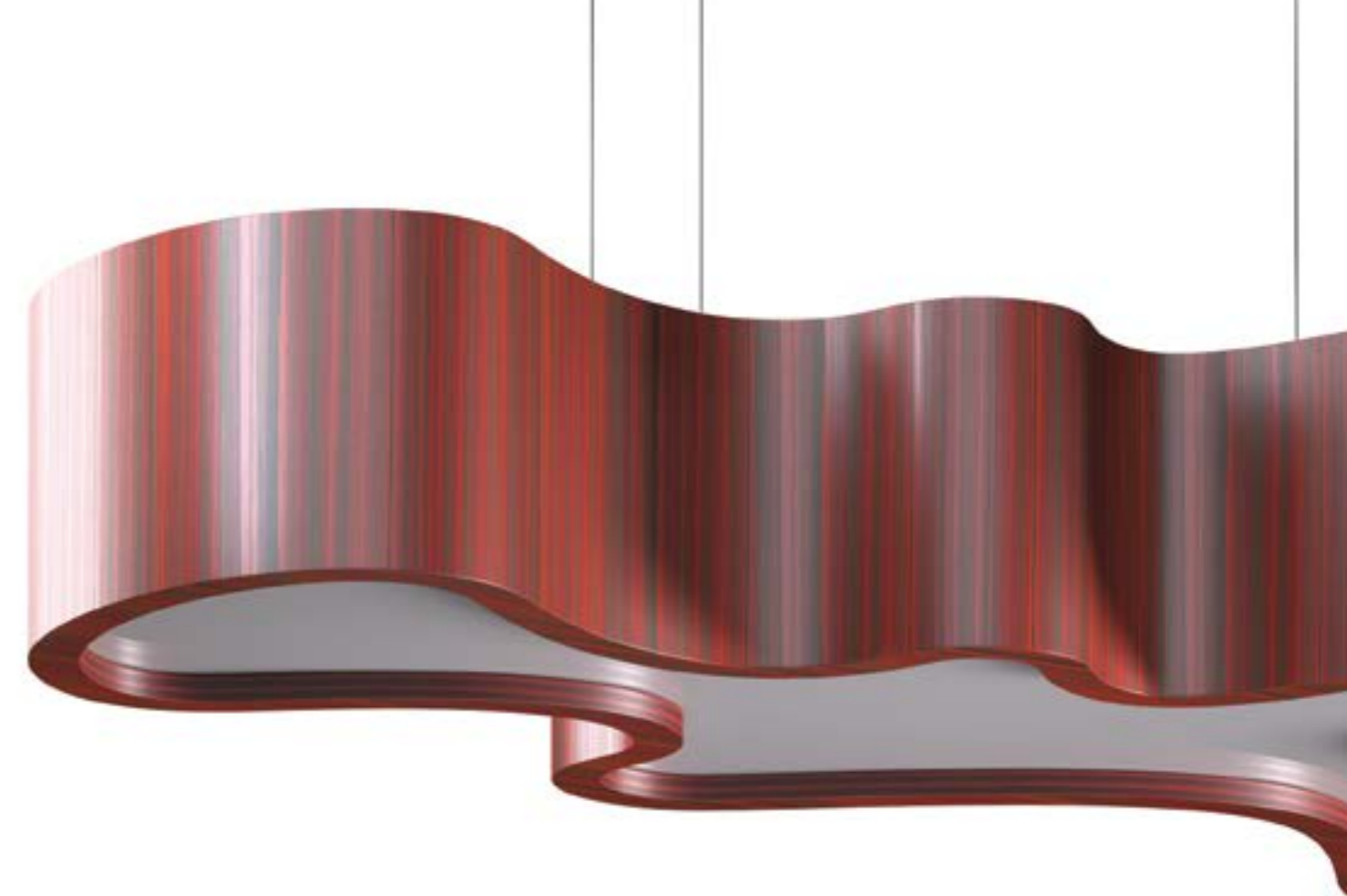

Atego 105 wisząca / hanging lamp

new IP20 F P

| | | | |
|-------------------------------------|---|---|---|
| | <p>Poliwęglan</p> | <p>Kryształy duże</p> | <p>Kryształy małe</p> |
| <p>4x max 23W, 230V, 50Hz</p> | <p>Index 12391ABZP1 color 2, 11</p> | <p>Index 12391ABZD1 color 2, 11</p> | <p>Index 12391ABZM1 color 2, 11</p> |
| <p>3x 36W, 230V, 50Hz, PL-L</p> | <p>Index 12391ABZP2 color 2, 11</p> | <p>Index 12391ABZD2 color 2, 11</p> | <p>Index 12391ABZM2 color 2, 11</p> |
| <p>36W, 3492lm, 3000K 4000K</p> | <p>Index 12391ABZPK5 color 2, 11</p> | <p>Index 12391ABZDK5 color 2, 11</p> | <p>Index 12391ABZMK5 color 2, 11</p> |



Atego 140 wisząca / hanging lamp

new IP20 F P

| | | | | | | | |
|-------------------------------------|---|---|---|---------------------------------|--|--|--|
| | <p>Poliwęglan</p> | <p>Kryształy duże</p> | <p>Kryształy małe</p> | | | | |
| | | | | <p>5x max 23W, 230V, 50Hz</p> | <p>Index 12391CCZP1 color 2, 11</p> | <p>Index 12391CCZD1 color 2, 11</p> | <p>Index 12391CCZM1 color 2, 11</p> |
| | | | | <p>3x 36W, 230V, 50Hz, PL-L</p> | <p>Index 12391CCZP2 color 2, 11</p> | <p>Index 12391CCZD2 color 2, 11</p> | <p>Index 12391CCZM2 color 2, 11</p> |
| <p>90W, 8730lm, 3000K 4000K</p> | <p>Index 12391CCZPK6 color 2, 11</p> | <p>Index 12391CCZDK6 color 2, 11</p> | <p>Index 12391CCZMK6 color 2, 11</p> | | | | |

Atego 180 wisząca / hanging lamp

new IP20 F P

| | | | | | | | |
|---------------------------------------|---|---|---|---------------------------------|--|--|--|
| | <p>Poliwęglan</p> | <p>Kryształy duże</p> | <p>Kryształy małe</p> | | | | |
| | | | | <p>6x max 23W, 230V, 50Hz</p> | <p>Index 12391DDZP1 color 2, 11</p> | <p>Index 12391DDZD1 color 2, 11</p> | <p>Index 12391DDZM1 color 2, 11</p> |
| | | | | <p>4x 36W, 230V, 50Hz, PL-L</p> | <p>Index 12391DDZP2 color 2, 11</p> | <p>Index 12391DDZD2 color 2, 11</p> | <p>Index 12391DDZM2 color 2, 11</p> |
| <p>108W, 10476lm, 3000K 4000K</p> | <p>Index 12391DDZPD4 color 2, 11</p> | <p>Index 12391DDZDD4 color 2, 11</p> | <p>Index 12391DDZMD4 color 2, 11</p> | | | | |



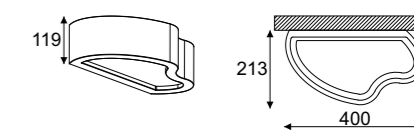

Poliwęglan



1x max 23W, 230V, 50Hz

Index
12395LP1
color 2, 11

Index
12395PP1
color 2, 11



9W, 873lm, 3000K
4000K

Index
12395LPL5
color 2, 11

Index
12395PPL5
color 2, 11

Kryształy duże

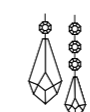

1x max 23W, 230V, 50Hz

Index
12395LD1
color 2, 11

Index
12395PD1
color 2, 11



9W, 873lm, 3000K
4000K

Index
12395LDL5
color 2, 11

Index
12395PDL5
color 2, 11

Kryształy małe



1x max 23W, 230V, 50Hz

Index
12395LM1
color 2, 11

Index
12395PM1
color 2, 11



9W, 873lm, 3000K
4000K

Index
12395LML5
color 2, 11

Index
12395PML5
color 2, 11

W ofercie również Atego kinkiet 33 dostępny na naszej stronie internetowej www.cleoni.pl

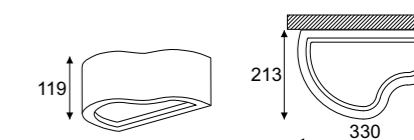

Atego



Atego



Atego model 10 stojąca / floor - standing

Index



2x max 23W, 230V, 50Hz

123910AS1
color 2, 9



18W, 1746lm, 3000K
4000K

123910ASK4
color 2, 9

symetryczna
symmetric

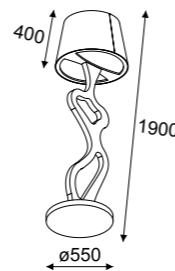

Atego model 10 stojąca / floor - standing

Index

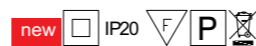

2x max 23W, 230V, 50Hz

123910AA1
color 2, 9



18W, 1746lm, 3000K
4000K

123910AAK4
color 2, 9

asymetryczna
asymmetric

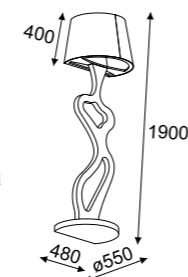

Atego model 8 stojąca / floor - standing

Index

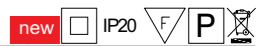

2x max 23W, 230V, 50Hz

12398AS1
color 2, 9



18W, 1746lm, 3000K
4000K

12398ASK4
color 2, 9

symetryczna
symmetric

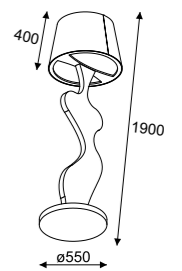

Atego model 8 stojąca / floor - standing

Index

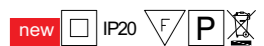

2x max 23W, 230V, 50Hz

12398AA1
color 2, 9



18W, 1746lm, 3000K
4000K

12398AAK4
color 2, 9

asymetryczna
asymmetric

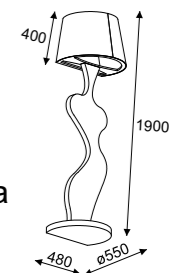

Woman



Woman 1297A1



2x max 23W, 230V, 50Hz

Index

1297A1

Abażur: color 2, 9, 10, 11
Podstawa: color 2, 9, 10, 11



18W, 1746lm, 3000K
4000K

1297AK4

Abażur: color 2, 9, 10, 11
Podstawa: color 2, 9, 10, 11

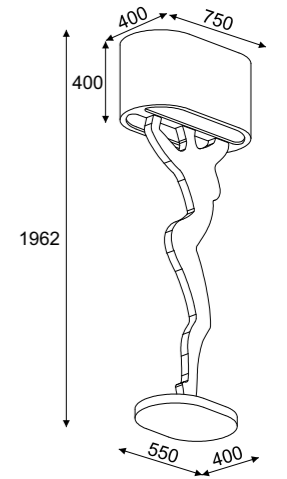

Woman 1297D1



2x max 23W, 230V, 50Hz

Index

1297D1

Abażur: color 2, 9, 10, 11
Podstawa: color 2, 9, 10, 11



18W, 1746lm, 3000K
4000K

1297DK4

Abażur: color 2, 9, 10, 11
Podstawa: color 2, 9, 10, 11

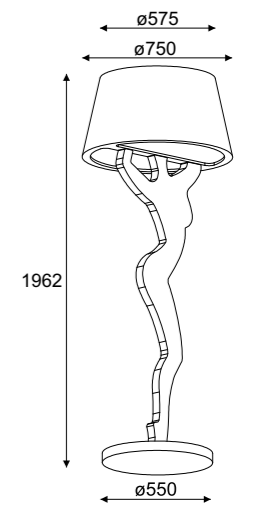









Lola wisząca / hanging lamp

Index

new IP20 F P X



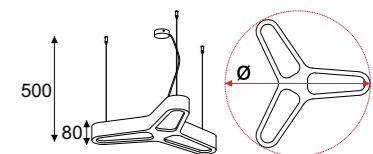



- 

3x 36W, 230V, 50Hz, ø1000
1293ADWPP
color 2,11
- 

3x 24W, 230V, 50Hz, ø780
1293AMWPP
color 2,11
- 
LED ECO
27W, 2619lm, 3000K / 4000K ø1000
1293ADWPL7
color 2,11
- 
LED ECO
27W, 2619lm, 3000K / 4000K ø780
1293AMWPL7
color 2,11



Lola plafon / ceiling lamp

Index

new IP20 F P X

- 

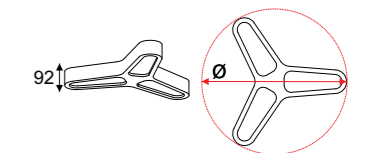
3x 36W, 230V, 50Hz, ø1000
1293ADPPP
color 2, 11
- 

3x 24W, 230V, 50Hz, ø780
1293AMPPP
color 2,11
- 
LED ECO
27W, 2619lm, 3000K / 4000K, ø1000
1293ADPPL7
color 2, 11
- 
LED ECO
27W, 2619lm, 3000K / 4000K, ø780
1293AMPPL7
color 2, 11





| | | | | | | | |
|--|-----------------------------------|-------------------|--|--|--|--|--|
| Pili 1295E wisząca / hanging lamp | | Index | | | | | |
| | 2x 36W, 230V, 50Hz, ø1000 | 1295EDWPP | | | | | |
| | | color 2, 11 | | | | | |
| | 2x 24W, 230V, 50Hz, ø780 | 1295EMWPT | | | | | |
| | | color 2, 11 | | | | | |
| | 18W, 1746lm, 3000K / 4000K, ø1000 | 1295EDWPK4 | | | | | |
| | | color 2, 11 | | | | | |
| | 18W, 1746lm, 3000K / 4000K, ø780 | 1295EMWPK4 | | | | | |
| | | color 2, 11 | | | | | |
| | | | | | | | |
| Pili 1295H wisząca / hanging lamp | | Index | | | | | |
| | 2x 36W, 230V, 50Hz, ø1000 | 1295HDWPP | | | | | |
| | | color 2, 11 | | | | | |
| | 2x 24W, 230V, 50Hz, ø780 | 1295HMWPT | | | | | |
| | | color 2, 11 | | | | | |
| | 18W, 1746lm, 3000K / 4000K, ø1000 | 1295HDWPK4 | | | | | |
| | | color 2, 11 | | | | | |
| | 18W, 1746lm, 3000K / 4000K, ø780 | 1295HMWPK4 | | | | | |
| | | color 2, 11 | | | | | |
| | | | | | | | |
| Pili 1295A wisząca / hanging lamp | | Index | | | | | |
| | 3x 36W, 230V, 50Hz, ø1000 | 1295ADWPP | | | | | |
| | | color 2, 11 | | | | | |
| | 3x 24W, 230V, 50Hz, ø780 | 1295AMWPT | | | | | |
| | | color 2, 11 | | | | | |
| | 27W, 2619lm, 3000K / 4000K, ø1000 | 1295ADWPL7 | | | | | |
| | | color 2, 11 | | | | | |
| | 27W, 2619lm, 3000K / 4000K, ø780 | 1295AMWPL7 | | | | | |
| | | color 2, 11 | | | | | |
| | | | | | | | |
| Pili 1295B wisząca / hanging lamp | | Index | | | | | |
| | 3x 36W, 230V, 50Hz, ø1000 | 1295BDWPP | | | | | |
| | | color 2, 11 | | | | | |
| | 3x 24W, 230V, 50Hz, ø780 | 1295BMWPT | | | | | |
| | | color 2, 11 | | | | | |
| | 27W, 2619lm, 3000K / 4000K, ø1000 | 1295BDWPL7 | | | | | |
| | | color 2, 11 | | | | | |
| | 27W, 2619lm, 3000K / 4000K, ø780 | 1295BMWPL7 | | | | | |
| | | color 2, 11 | | | | | |
| | | | | | | | |
| Pili 1295C wisząca / hanging lamp | | Index | | | | | |
| | 3x 36W, 230V, 50Hz, ø1000 | 1295CDWPP | | | | | |
| | | color 2, 11 | | | | | |
| | 3x 24W, 230V, 50Hz, ø780 | 1295CMWPT | | | | | |
| | | color 2, 11 | | | | | |
| | 27W, 2619lm, 3000K / 4000K, ø1000 | 1295CDWPL7 | | | | | |
| | | color 2, 11 | | | | | |
| | 27W, 2619lm, 3000K / 4000K, ø780 | 1295CMWPL7 | | | | | |
| | | color 2, 11 | | | | | |
| | | | | | | | |
| Pili 1295D wisząca / hanging lamp | | Index | | | | | |
| | 4x 36W, 230V, 50Hz, ø1000 | 1295DDWPP | | | | | |
| | | color 2, 11 | | | | | |
| | 4x 24W, 230V, 50Hz, ø780 | 1295DMWPT7 | | | | | |
| | | color 2, 11 | | | | | |
| | 36W, 3492lm, 3000K / 4000K, ø1000 | 1295DDWPK5 | | | | | |
| | | color 2, 11 | | | | | |
| | 36W, 3492lm, 3000K / 4000K, ø780 | 1295DMWPK5 | | | | | |
| | | color 2, 11 | | | | | |
| | | | | | | | |



| | | | |
|---|-----------------------------------|----------------------------------|--|
| Pili 1295E plafon / ceiling lamp | | Index | |
| | 2x 36W, 230V, 50Hz, ø1000 | 1295EDPPP color 2, 11 | |
| | 2x 24W, 230V, 50Hz, ø780 | 1295EMPPT color 2, 11 | |
| | 18W, 1746lm, 3000K / 4000K, ø1000 | 1295EDPPK4 color 2, 11 | |
| | 18W, 1746lm, 3000K / 4000K, ø780 | 1295EMPPK4 color 2, 11 | |
| Pili 1295H plafon / ceiling lamp | | Index | |
| | 2x 36W, 230V, 50Hz, ø1000 | 1295HDPPP color 2, 11 | |
| | 2x 24W, 230V, 50Hz, ø780 | 1295HMPPT color 2, 11 | |
| | 18W, 1746lm, 3000K / 4000K, ø1000 | 1295HDPPK4 color 2, 11 | |
| | 18W, 1746lm, 3000K / 4000K, ø780 | 1295HMPPK4 color 2, 11 | |
| Pili 1295A plafon / ceiling lamp | | Index | |
| | 3x 36W, 230V, 50Hz, ø1000 | 1295ADPPP color 2, 11 | |
| | 3x 24W, 230V, 50Hz, ø780 | 1295AMPPT color 2, 11 | |
| | 27W, 2619lm, 3000K / 4000K, ø1000 | 1295ADPPL7 color 2, 11 | |
| | 27W, 2619lm, 3000K / 4000K, ø780 | 1295AMPPL7 color 2, 11 | |
| Pili 1295B plafon / ceiling lamp | | Index | |
| | 3x 36W, 230V, 50Hz, ø1000 | 1295BDPPP color 2, 11 | |
| | 3x 24W, 230V, 50Hz, ø780 | 1295BMPPT color 2, 11 | |
| | 27W, 2619lm, 3000K / 4000K, ø1000 | 1295BDPPL7 color 2, 11 | |
| | 27W, 2619lm, 3000K / 4000K, ø780 | 1295BMPPL7 color 2, 11 | |
| Pili 1295C plafon / ceiling lamp | | Index | |
| | 3x 36W, 230V, 50Hz, ø1000 | 1295CDPPP color 2, 11 | |
| | 3x 24W, 230V, 50Hz, ø780 | 1295CMPPT color 2, 11 | |
| | 27W, 2619lm, 3000K / 4000K, ø1000 | 1295CDPPL7 color 2, 11 | |
| | 27W, 2619lm, 3000K / 4000K, ø780 | 1295CMPPL7 color 2, 11 | |
| Pili 1295D plafon / ceiling lamp | | Index | |
| | 4x 36W, 230V, 50Hz, ø1000 | 1295DDPPP color 2, 11 | |
| | 4x 24W, 230V, 50Hz, ø780 | 1295DMPPT color 2, 11 | |
| | 36W, 3492lm, 3000K / 4000K, ø1000 | 1295DDPPK5 color 2, 11 | |
| | 36W, 3492lm, 3000K / 4000K, ø780 | 1295DMPPK5 color 2, 11 | |

Albino



Albino wisząca / hanging lamp

59W, 6435lm, 3000K
4000K

Index

1253AW1K2
color 2, 9, 11

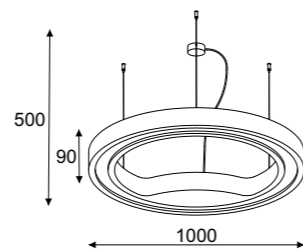

Drekar



Drekar wisząca / hanging lamp

49W, 5363lm, 3000K
4000K

Index

1332A1K3
color 2, 9, 11

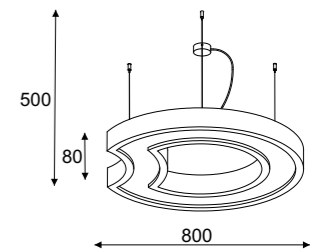
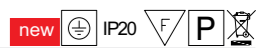

Lukomo



Lukomo 30 niska plafon / low ceiling lamp

Index



1x max 23W, 230V, 50Hz

8664A1
color 2



19W, 2066lm, 3000K / 4000K

8664PAL1
color 2

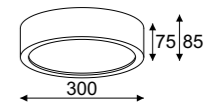

Lukomo 35 niska plafon / low ceiling lamp

Index



2x max 23W, 230V, 50Hz

8658A2
color 2



1x 22W, 230V, 50Hz

8658H
color 2



19W, 2066lm, 3000K / 4000K

8658PBL1
color 2

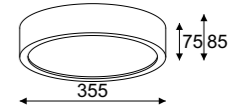

Lukomo 43 niska plafon / low ceiling lamp

Index



3x max 23W, 230V, 50Hz

8652A3
color 2



1x 40W, 230V, 50Hz

8652H4
color 2



1x 55W, 230V, 50Hz

8652H5
color 2



25W, 2755lm, 3000K / 4000K

8652PCL2
color 2

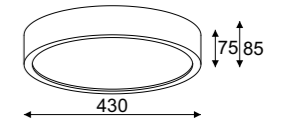

Lukomo 60 niska plafon / low ceiling lamp

Index



6x max 23W, 230V, 50Hz

8645E6
color 2



3x 22W, 230V, 50Hz

8645T3
color 2



3x 18W, 230V, 50Hz

8645P3
color 2



75W, 8265lm, 3000K / 4000K

8645PDD3
color 2

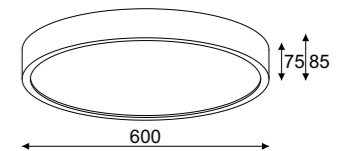

Lukomo 70 niska plafon / low ceiling lamp

Index



8x max 23W, 230V, 50Hz

8644E8
color 2



4x 22W, 230V, 50Hz

8644T4
color 2



4x 18W, 230V, 50Hz

8644P4
color 2



75W, 8265lm, 3000K / 4000K

8644PED3
color 2

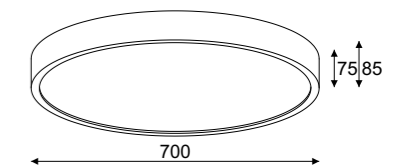

Lukomo 80 niska plafon / low ceiling lamp

Index



8x max 23W, 230V, 50Hz

8643E8
color 2



4x 40W, 230V, 50Hz

8643T4
color 2



4x 18W, 230V, 50Hz

8643P4
color 2



117W, 2755lm, 3000K / 4000K

8643PHD5
color 2

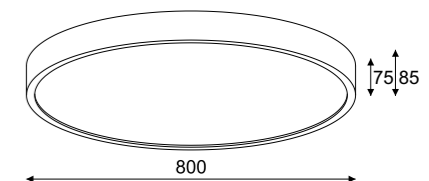



Lukomo 30 niska wisząca / low hanging lamp

Index

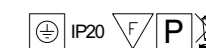

1x max 23W, 230V, 50Hz

8665A1
color 2



19W, 2066lm, 3000K / 4000K

8665ZAL1
color 2

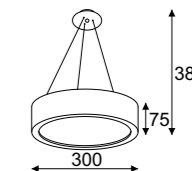

Lukomo 35 niska wisząca / low hanging lamp

Index

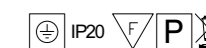

2x max 23W, 230V, 50Hz

8659A2
color 2



1x 22W, 230V, 50Hz

8659H
color 2



19W, 2066lm, 3000K / 4000K

8659ZBL1
color 2

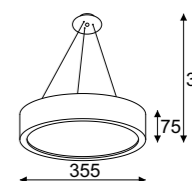

Lukomo 43 niska wisząca / low hanging lamp

Index

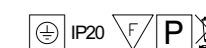

3x max 23W, 230V, 50Hz

8653A3
color 2



1x 40W, 230V, 50Hz

8653H4
color 2



1x 55W, 230V, 50Hz

8653H5
color 2



25W, 2755lm, 3000K / 4000K

8653ZCL2
color 2

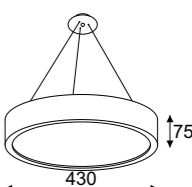

Lukomo 60 niska wisząca / low hanging lamp

Index

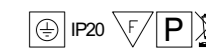

6x max 23W, 230V, 50Hz

8645K6
color 2



3x 22W, 230V, 50Hz

8645H3
color 2



3x 18W, 230V 50Hz

8645U3
color 2



75W, 8265lm, 3000K / 4000K

8645ZDD3
color 2

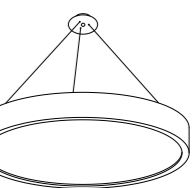

Lukomo 70 niska wisząca / low hanging lamp

Index

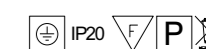

8x max 23W, 230V, 50Hz

8644K8
color 2



4x 22W, 230V, 50Hz

8644H4
color 2



4x 18W, 230V, 50Hz

8644U4
color 2



75W, 8265lm, 3000K / 4000K

8644ZED3
color 2

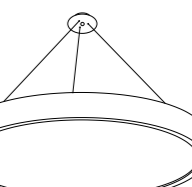

Lukomo 80 niska wisząca / low hanging lamp

Index

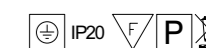

8x max 23W, 230V, 50Hz

8643K8
color 2



4x 40W, 230V, 50Hz

8643H4
color 2



4x 24W, 230V, 50Hz

8643U4
color 2



117W, 11349lm, 3000K / 4000K

8643ZHD7
color 2

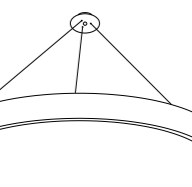



Lukomo 30 wysokie plafon / high ceiling lamp

Index

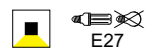
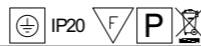

1x max 23W, 230V, 50Hz

8698A1
color 2



19W, 2066lm, 3000K / 4000K

8698PAL1
color 2

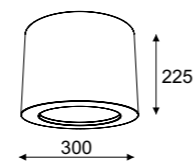

Lukomo 35 wysokie plafon / high ceiling lamp

Index

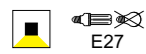
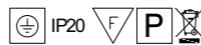

2x max 23W, 230V, 50Hz

8662A2
color 2



1x 22W, 230V, 50Hz

8662H
color 2



19W, 2066lm, 3000K / 4000K

8662PBL1
color 2

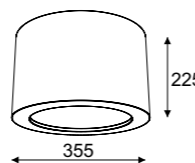

Lukomo 43 wysokie plafon / high ceiling lamp

Index

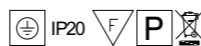

3x max 23W, 230V, 50Hz

8656A3
color 2



1x 40W, 230V, 50Hz

8656H4
color 2



1x 55W, 230V, 50Hz

8656H5
color 2



25W, 2755lm, 3000K / 4000K

8656PCL2
color 2

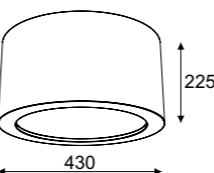

Lukomo 30 wysoka wiszaca / high hanging lamp

Index



1 x max 23W, 230V, 50Hz

8699A1
color 2



19W, 2066lm, 3000K / 4000K

8699ZAL1
color 2

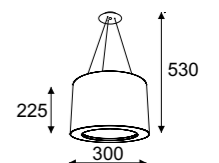

Lukomo 35 wysoka wiszaca / high hanging lamp

Index



2x max 23W, 230V, 50Hz

8663A2
color 2



1x 22W, 230V, 50Hz

8663H
color 2



19W, 2066lm, 3000K / 4000K

86632BL1
color 2

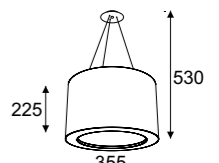

Lukomo 43 wysoka wiszaca / high hanging lamp

Index



3x max 23W, 230V, 50Hz

8657A3
color 2



1x 40W, 230V, 50Hz

8657H4
color 2



1x 55W, 230V, 50Hz

8657H5
color 2



25W, 2755lm, 3000K / 4000K

8657ZCL2
color 2

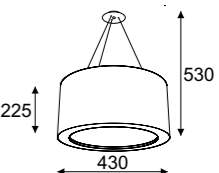

Nola



Nola



Nola W1 wisząca / hanging lamp

Index

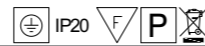

2x max 23W, 230V, 50Hz

3500W1E
color 2



18W, 1746lm, 3000K / 4000K

3500W1L6
color 2

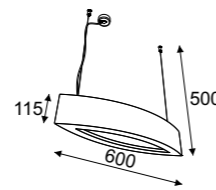

Nola W2 wisząca / hanging lamp

Index

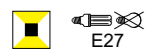
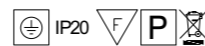

2x max 23W, 230V, 50Hz

3500W2E
color 2



2x 24W, 230V, 50Hz

3500W2P
color 2



27W, 2619lm, 3000K / 4000K

3500W2L7
color 2

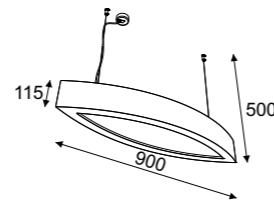

Nola W3 wisząca / hanging lamp

Index

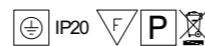

4x 36W, 230V, 50Hz

3500W3P
color 2

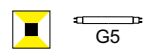

2x 21W, 230V, 50Hz

3500W3T
color 2



54W, 5238lm, 3000K / 4000K

3500W3L4
color 2

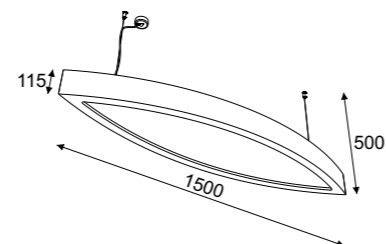

Nola K1 kinkiet / wall lamp

Index



1x max 23W, 230V, 50Hz

3500K1E
color 2



1x 18W, 230V, 50Hz

3500K1P
color 2



9W, 873lm, 3000K / 4000K

3500K1L5
color 2

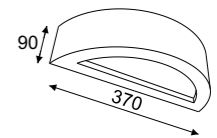

Nola K2 kinkiet / wall lamp

Index



2x max 23W, 230V, 50Hz

3500K2E
color 2



1x 24W, 230V, 50Hz

3500K2P
color 2



18W, 1746lm, 3000K / 4000K

3500K2L6
color 2

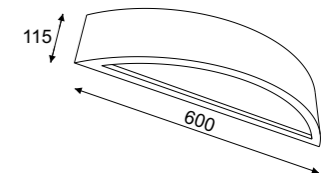

Nola K3 kinkiet / wall lamp

Index



2x max 23W, 230V, 50Hz

3500K3E
color 2



1x 36W, 230V, 50Hz

3500K3P
color 2



27W, 2619lm, 3000K / 4000K



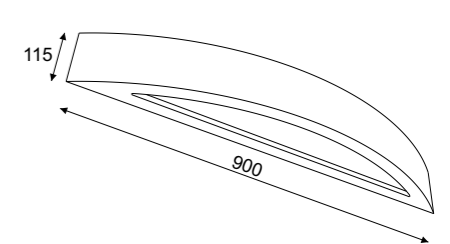

3500K3L7
color 2



Inge



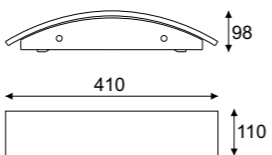





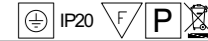
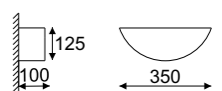

Inge kinkiet / wall lamp

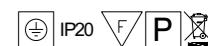
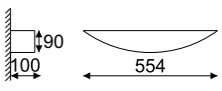
| | | | |
|--|--------------------------|--------------------------|---|
|  | 1x max 23W, 230V, 50Hz | 1205K1 color 2 |   |
|  | 9W, 873lm, 3000K / 4000K | 1205L5 color 2 | |

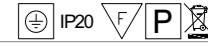
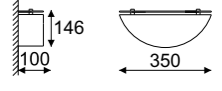
Chera

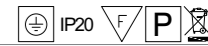
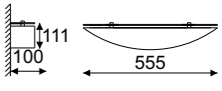

| | | | |
|---|----------------------------|---------------------------|---|
| Chera 35 otwarta / opened | | Index |   |
|  | 1x max 23W, 230V, 50Hz | 8716A1 color 2 | |
|  | 9W, 873lm, 3000K / 4000K | 8716L5 color 2 | |
| Chera 55 otwarta / opened | | Index |   |
|  | 2x max 23W, 230V, 50Hz | 8717A2 color 2 | |
|  | 18W, 1746lm, 3000K / 4000K | 8717L6 color 2 | |
| Chera 35 z górnym szkłem / with upper glass | | Index |   |
|  | 1x max 23W, 230V, 50Hz | 8716A1...color 2/s | |
|  | 9W, 873lm, 3000K / 4000K | 8716L5...color 2/6 | |
| Chera 55 z górnym szkłem / with upper glass | | Index |   |
|  | 2x max 23W, 230V, 50Hz | 8717A2...color 2/s | |
|  | 18W, 1746lm, 3000K / 4000K | 8717L6...color 2/s | |

Sandoya



Sandoya symetryczna, mała / symmetrical, small



3x max 23W, 230V, 50Hz

Index

1149H
color 2

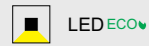

57W, 6198lm, 3000K / 4000K

1149K8
color 2

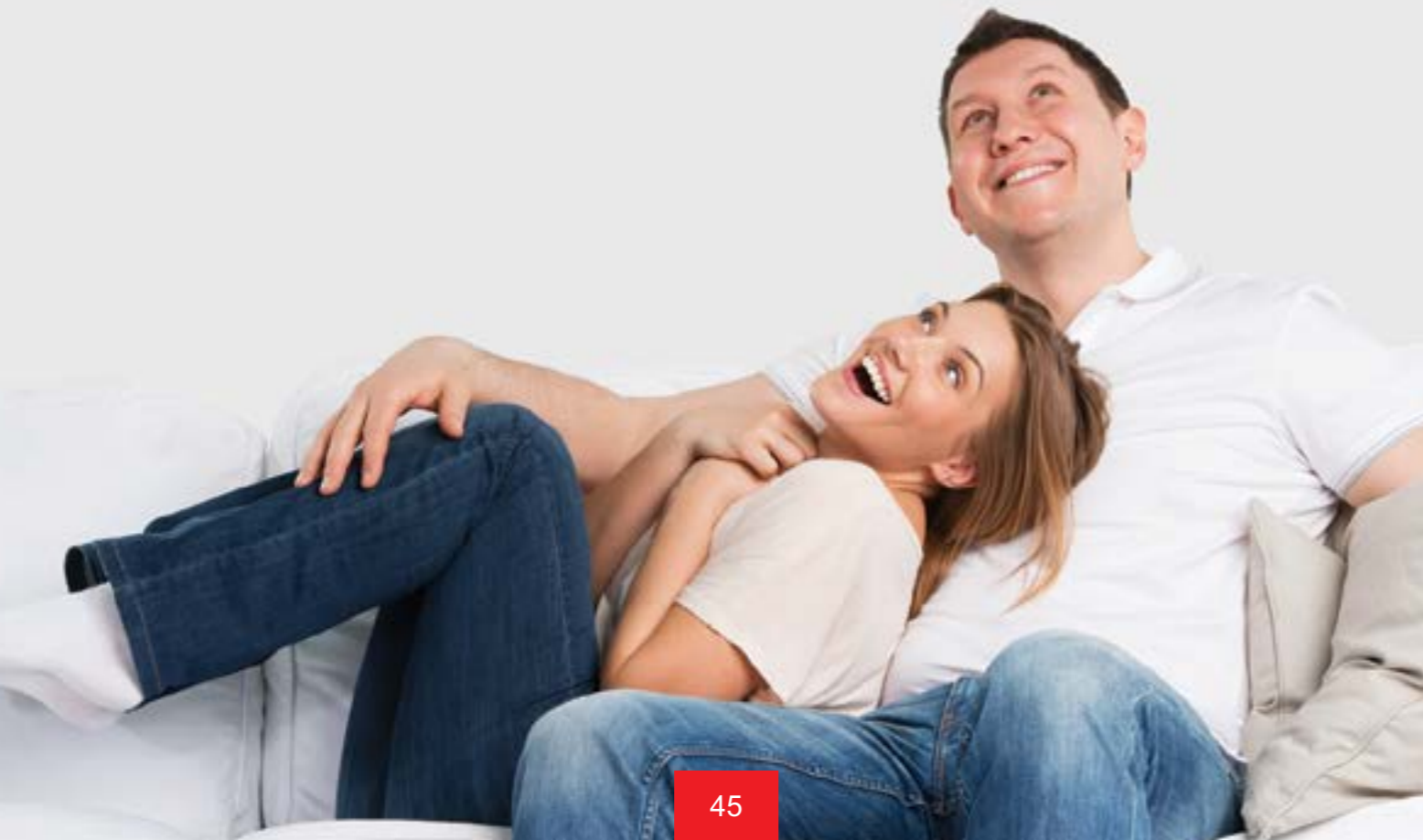
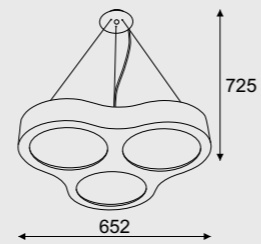

Santa Cruz



Santa Cruz wisząca / hanging lamp



4x max 23W, 230V, 50Hz

Index

1129H
color 2



2x 40W, 230V, 50Hz

1129C
color 2

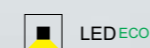

50W, 5510lm, 3000K / 4000K

1129HK9
color 2

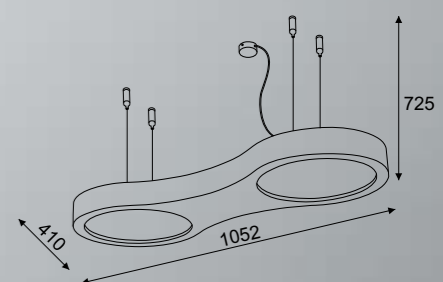

Lukomiko



Lukomiko

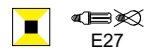

1x max 23W, 230V, 50Hz

Index

8692A1
color 2, 9

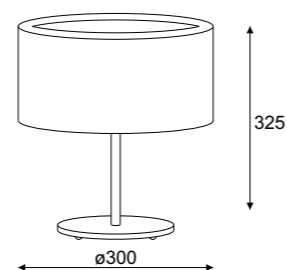

Esox



Esox



1x 22W, 230V, 50Hz

Index

1326NA1
color 2

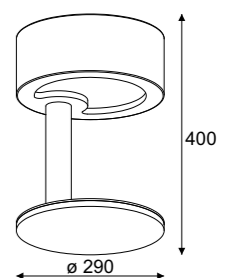

Verona



Verona plafon / ceiling lamp

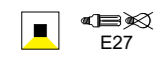

5x max 23W, 230V, 50Hz

Index

new IP20 F AL S P

1214P1
color przewodu...
color color 1
color color 2

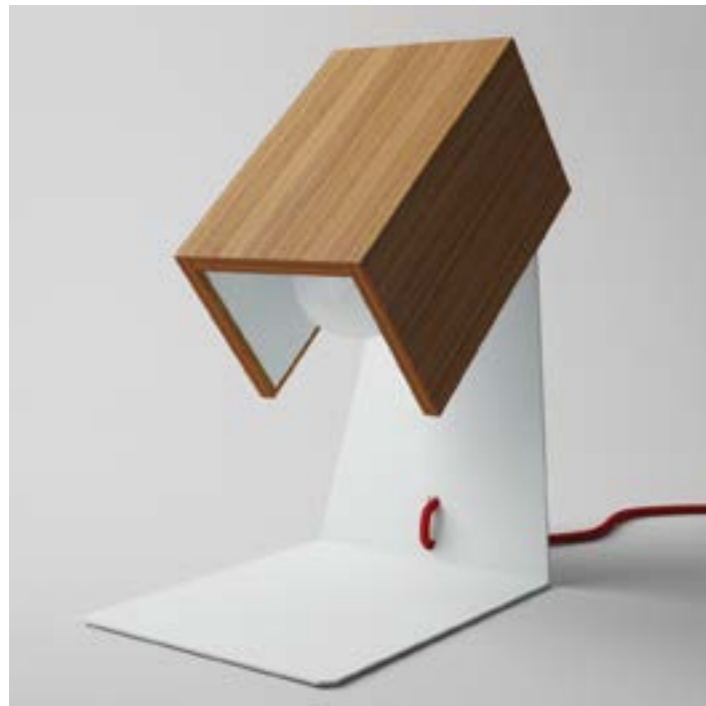
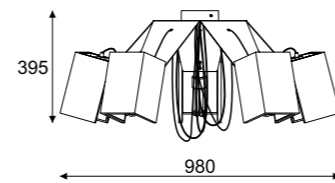

Verona stojąca

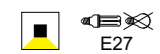

1x max 23W, 230V, 50Hz

Index

new IP20 F S P

1214N1
color przewodu...
color color 1
color color 2

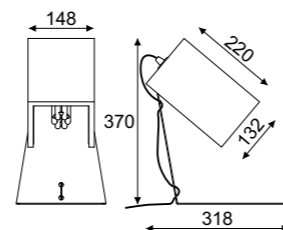

Verona wisząca / hanging lamp



5x max 23W, 230V, 50Hz

Index

new IP20 F AL S P

1214Z1
color przewodu...
color color 1
color color 2

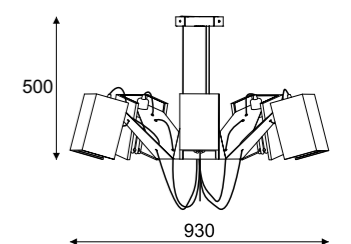

Moa



Moa 33 plafon / ceiling lamp



1x max 23W, 230V, 50Hz

Index



8650A1
color 2



19W, 2066lm, 3000K / 4000K

8650L1
color 2

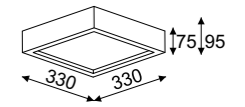

Moa 40 plafon / ceiling lamp



2x max 23W, 230V, 50Hz

Index



8648A2
color 2



1x 22W, 230V, 50Hz

8648K
color 2



25W, 2755lm, 3000K / 4000K

8648L2
color 2

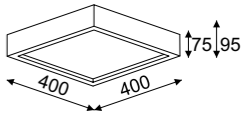

Moa 50 plafon / ceiling lamp



3x max 23W, 230V, 50Hz

Index



8646A3
color 2



1x 40W, 230V, 50Hz

8646H4
color 2



1x 55W, 230V, 50Hz

8646H5
color 2



25W, 2755lm, 3000K / 4000K

8646L2
color 2

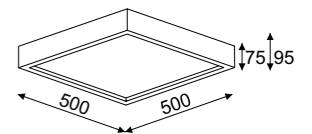

Moa 60 plafon / ceiling lamp



4x max 23W, 230V, 50Hz

Index



8637A4
color 2



4x 22W, 230V, 50Hz

8637T4
color 2



32W, 3444lm, 3000K / 4000K

8637L3
color 2



54W, 5238lm, 3000K / 4000K

8637L4
color 2

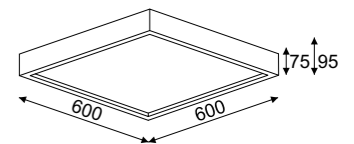

Moa 70 plafon / ceiling lamp



4x max 23W, 230V, 50Hz

Index



8638A4
color 2



4x 40W, 230V, 50Hz

8638T4
color 2



32W, 3444lm, 3000K / 4000K

8638L3
color 2



54W, 5238lm, 3000K / 4000K

8638L4
color 2

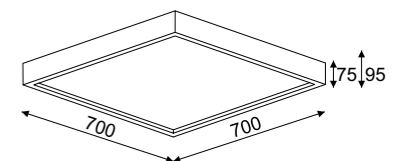

Moa 80 plafon / ceiling lamp



4x max 23W, 230V, 50Hz

Index



8639A4
color 2



4x 40W, 230V, 50Hz

8639T4
color 2



72W, 6984lm, 3000K / 4000K

8639L8
color 2

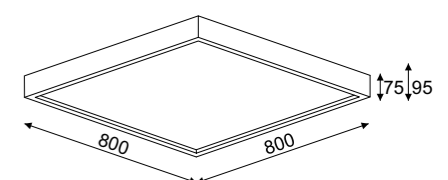

Moa



Moa 33 wisząca / hanging lamp



2x max 23W, 230V, 50Hz

Index

8651A2
color 2



19W, 2066lm, 3000K / 4000K

8651L1
color 2

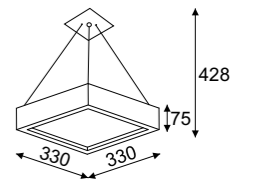

Moa 40 wisząca / hanging lamp



4x max 23W, 230V, 50Hz

Index

8649A4
color 2



1x 22W, 230V, 50Hz

8649K
color 2



25W, 2755lm, 3000K / 4000K

8649L2
color 2

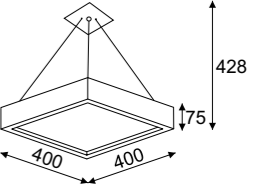

Moa 50 wisząca / hanging lamp



4x max 23W, 230V, 50Hz

Index

8647A4
color 2



1x 40W, 230V, 50Hz

8647H
color 2



1x 55W, 230V, 50Hz

8647K
color 2



25W, 2755lm, 3000K / 4000K

8647L2
color 2

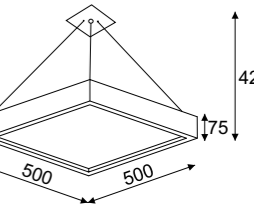

Moa 60 wisząca / hanging lamp

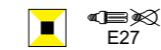

4x max 23W, 230V, 50Hz

Index

8637B4
color 2



4x 22W, 230V, 50Hz

8637H4
color 2



32W, 3444lm, 3000K / 4000K

8637L3
color 2



54W, 5238lm, 3000K / 4000K

8637L4
color 2

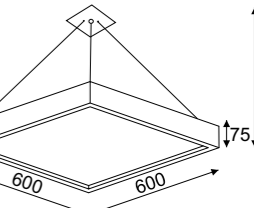

Moa 70 wisząca / hanging lamp



4x max 23W, 230V, 50Hz

Index

8638B4
color 2



4x 40W, 230V, 50Hz

8638H4
color 2



32W, 3444lm, 3000K / 4000K

8637L3
color 2



54W, 5238lm, 3000K / 4000K

8637L4
color 2

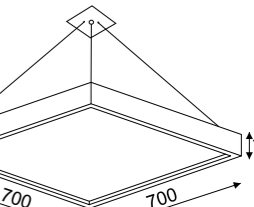

Moa 80 wisząca / hanging lamp



4x max 23W, 230V, 50Hz

Index

8639B4
color 2



4x 40W, 230V, 50Hz

8639H4
color 2



73W, 6984lm, 3000K / 4000K

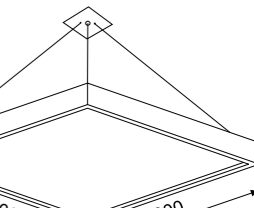

8639L8
color 2





Amur



Amur 40 plafon / ceiling lamp

| | | |
|---|----------------------------|--|
|  E27 | 3x max 60W, 230V, 50Hz | 1306P41E color 1 color 2 |
|  2GX13 | 1x 40W, 230V, 50Hz | 1306P42T color 1 color 2 |
|  LED ECO | 25W, 2755lm, 3000K / 4000K | 1306P44L2 color 1 color 2 |



Amur 50 plafon / ceiling lamp

| | | |
|---|----------------------------|--|
|  E27 | 3x max 60W, 230V, 50Hz | 1306P51E color 1 color 2 |
|  2GX13 | 1x 40W, 230V, 50Hz | 1306P52T color 1 color 2 |
|  LED ECO | 25W, 2755lm, 3000K / 4000K | 1306P55L2 color 1 color 2 |

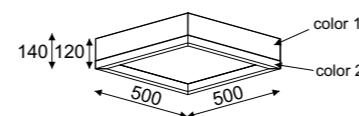
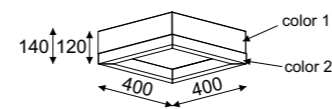

Index





Amur 40 wisząca / hanging lamp

| | | |
|---|----------------------------|--|
|  E27 | 3x max 60W, 230V, 50Hz | 1306W41E color 1 color 2 |
|  2GX13 | 1x 40W, 230V, 50Hz | 1306W42T color 1 color 2 |
|  LED ECO | 25W, 2755lm, 3000K / 4000K | 1306W44L2 color 1 color 2 |



Amur 50 wisząca / hanging lamp

| | | |
|---|----------------------------|--|
|  E27 | 3x max 60W, 230V, 50Hz | 1306W51E color 1 color 2 |
|  2GX13 | 1x 40W, 230V, 50Hz | 1306W52T color 1 color 2 |
|  LED ECO | 25W, 2755lm, 3000K / 4000K | 1306W55L2 color 1 color 2 |

Amur 40 kinkiet / wall lamp

| | | |
|---|--------------------------|--|
|  E27 | 1x max 60W, 230V, 50Hz | 1305K41E color 1 color 2 |
|  LED ECO | 9W, 873lm, 3000K / 4000K | 1306K46L5 color 1 color 2 |

Amur 50 kinkiet / wall lamp

| | | |
|---|--------------------------|--|
|  E27 | 2x max 60W, 230V, 50Hz | 1305K51E color 1 color 2 |
|  LED ECO | 9W, 873lm, 3000K / 4000K | 1306K56L5 color 1 color 2 |

Index

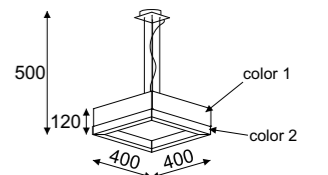

Index

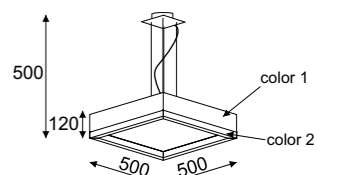

Index

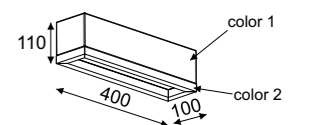

Index

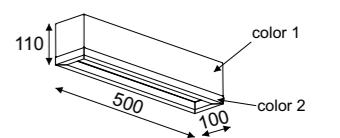

Bops



Bops 40 wisząca / hanging lamp

| | | Index |
|--|----------------------------|--|
| | 3x max 60W, 230V, 50Hz | 1305W41E color 1 color 2 |
| | 1x 40W, 230V, 50Hz | 1305W42T color 1 color 2 |
| | 25W, 2755lm, 3000K / 4000K | 1305W44L2 color 1 color 2 |

IP20 F S P

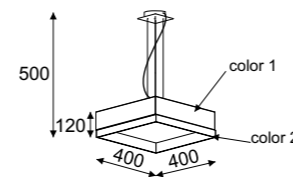

Bops 50 wisząca / hanging lamp

| | | Index |
|--|----------------------------|--|
| | 3x max 60W, 230V, 50Hz | 1305W51E color 1 color 2 |
| | 1x 40W, 230V, 50Hz | 1305W52T color 1 color 2 |
| | 25W, 2755lm, 3000K / 4000K | 1305W55L2 color 1 color 2 |

IP20 F S P

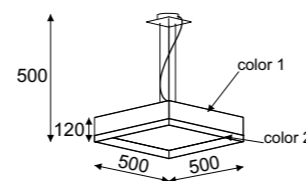

Bops 40 plafon / ceiling lamp

| | | Index |
|--|----------------------------|--|
| | 3x max 60W, 230V, 50Hz | 1305P41E color 1 color 2 |
| | 1x 40W, 230V, 50Hz | 1305P42T color 1 color 2 |
| | 25W, 2755lm, 3000K / 4000K | 1305P44L2 color 1 color 2 |

IP20 F S P

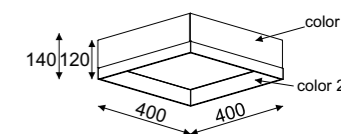

Bops 50 plafon / ceiling lamp

| | | Index |
|--|----------------------------|--|
| | 3x max 60W, 230V, 50Hz | 1305P51E color 1 color 2 |
| | 1x 40W, 230V, 50Hz | 1305P52T color 1 color 2 |
| | 25W, 2755lm, 3000K / 4000K | 1305P55L2 color 1 color 2 |

IP20 F S P

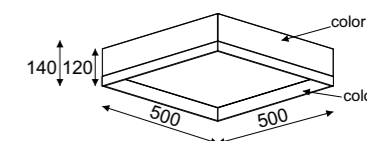

Bops 40 kinkiet / wall lamp

| | | Index |
|--|--------------------------|--|
| | 1x max 60W, 230V, 50Hz | 1305K41E color 1 color 2 |
| | 9W, 873lm, 3000K / 4000K | 1305K46L5 color 1 color 2 |

IP20 F S P

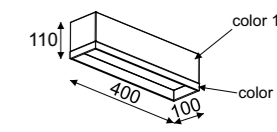

Bops 50 kinkiet / wall lamp

| | | Index |
|--|--------------------------|--|
| | 2x max 60W, 230V, 50Hz | 1305K51E color 1 color 2 |
| | 9W, 873lm, 3000K / 4000K | 1305K56L5 color 1 color 2 |

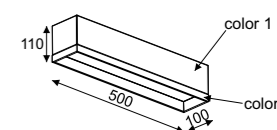

IP20 F S P







Caspe

Caspe 12 z dolnym szkłem / with bottom glass

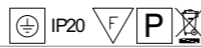
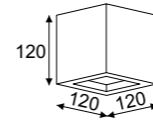
| | | |
|--|------------------------|--------------------------|
|  | 1x max 40W, 230V, 50Hz | 8816A1 color 2 |
|  | 1x max 40W, 230V, 50Hz | 8816H color 2 |



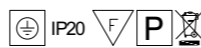
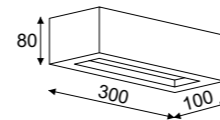

Caspe 30 z dolnym szkłem / with bottom glass

| | | |
|--|--------------------------|--------------------------|
|  | 1x max 23W, 230V, 50Hz | 8814A1 color 2 |
|  | 9W, 873lm, 3000K / 4000K | 8814L5 color 2 |



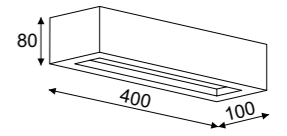

Caspe 40 z dolnym szkłem / with bottom glass

| | | |
|---|--------------------------|--------------------------|
|  | 1 x max 23W, 230V, 50Hz | 8812A1 color 2 |
|  | 9W, 873lm, 3000K / 4000K | 8812L5 color 2 |



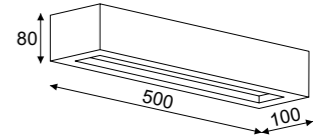

Caspe 50 z dolnym szkłem / with bottom glass

| | | |
|---|--------------------------|--------------------------|
|  | 2x max 23W, 230V, 50Hz | 8810A2 color 2 |
|  | 9W, 873lm, 3000K / 4000K | 8810L5 color 2 |



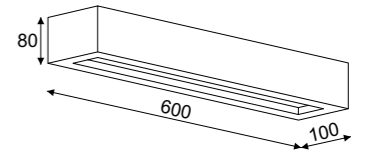

Caspe 60 z dolnym szkłem / with bottom glass

| | | |
|---|----------------------------|--------------------------|
|  | 2x max 23W, 230V, 50Hz | 8808A2 color 2 |
|  | 18W, 1746lm, 3000K / 4000K | 8808L6 color 2 |



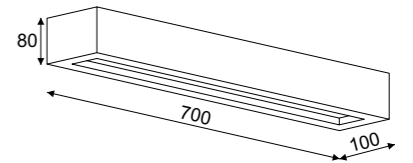

Caspe 70 z dolnym szkłem / with bottom glass

| | | |
|---|----------------------------|--------------------------|
|  | 2x max 23W, 230V, 50Hz | 8806A2 color 2 |
|  | 18W, 1746lm, 3000K / 4000K | 8806L6 color 2 |



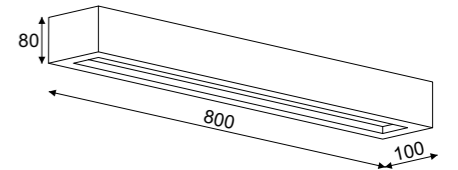

Caspe 80 z dolnym szkłem / with bottom glass

| | | |
|---|----------------------------|--------------------------|
|  | 3x max 23W, 230V, 50Hz | 8804A3 color 2 |
|  | 18W, 1746lm, 3000K / 4000K | 8804L6 color 2 |



Caspe 90 z dolnym szkłem / with bottom glass

| | | |
|---|----------------------------|--------------------------|
|  | 3x max 23W, 230V, 50Hz | 8802A3 color 2 |
|  | 27W, 2619lm, 3000K / 4000K | 8802L7 color 2 |

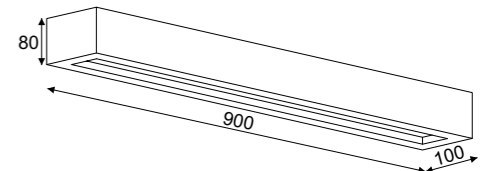

Caspe



Caspe 30 z dolnym i górnym szkłem /
with bottom and upper glass

Index

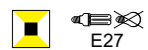
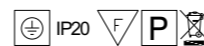

1x max 23W, 230V, 50Hz **8814A1**...color 2/s



9W, 873lm, 3000K / 4000K **8814L5**...color 2/s

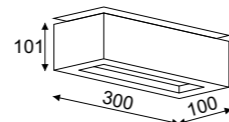

Caspe 40 z dolnym i górnym szkłem /
with bottom and upper glass

Index

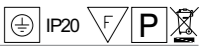

1x max 23W, 230V, 50Hz **8812A1**...color 2/s



9W, 873lm, 3000K / 4000K **8812L5**...color 2/s

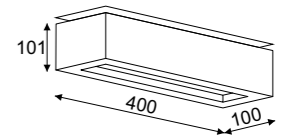

Caspe 50 z dolnym i górnym szkłem /
with bottom and upper glass

Index



2x max 23W, 230V, 50Hz **8810A2**...color 2/s



9W, 873lm, 3000K / 4000K **8810L5**...color 2/s

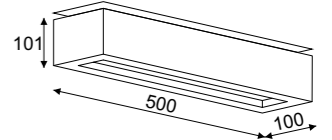

Caspe 60 z dolnym i górnym szkłem /
with bottom and upper glass

Index



2x max 23W, 230V, 50Hz **8808A2**...color 2/s



18W, 1746lm, 3000K / 4000K **8808L6**...color 2/s

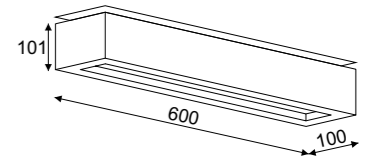

Caspe 70 z dolnym i górnym szkłem /
with bottom and upper glass

Index



2x max 23W, 230V, 50Hz **8806A2**...color 2/s



18W, 1746lm, 3000K / 4000K **8806L6**...color 2/s

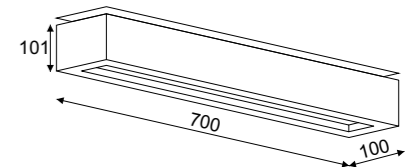

Caspe 80 z dolnym i górnym szkłem /
with bottom and upper glass

Index



3x max 23W, 230V, 50Hz **8804A3**...color 2/s



18W, 1746lm, 3000K / 4000K **8804L6**...color 2/s

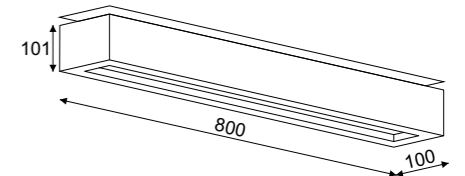

Caspe 90 z dolnym i górnym szkłem /
with bottom and upper glass

Index



3x max 23W, 230V, 50Hz **8802A3**...color 2/s



27W, 2619lm, 3000K / 4000K **8802L7**...color 2/s

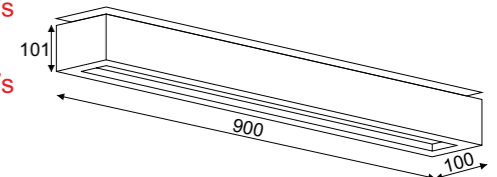

Tubak



Tubak wersja mała / small



1x max 23W, 230V, 50Hz

Index

1203T1M
color 2

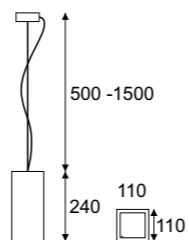

Tubak wersja średnia / medium



1x max 23W, 230V, 50Hz

Index

1203T1S
color 2

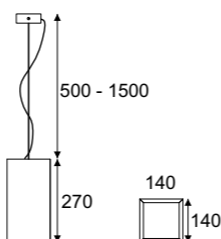

Oczko stropowe / downlight



Wersja okrągła Rounded version



1x max 40W, 230V, 50Hz

Index

1199O1E
color 2



1x max 35W, 230V, 50Hz

1199O1G
color 2



1 x max 35W, 230V, 50Hz

1199O1U
color 2

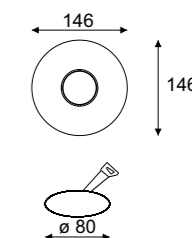

Wersja kwadratowa Square version



1x max 40W, 230V, 50Hz

Index

1199K1E
color 2



1x max 35W, 230V, 50Hz

1199K1G
color 2



1 x max 35W, 230V, 50Hz

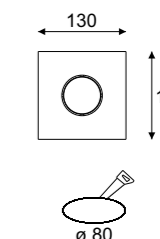

1199K1U
color 2



Obrazy z drewna



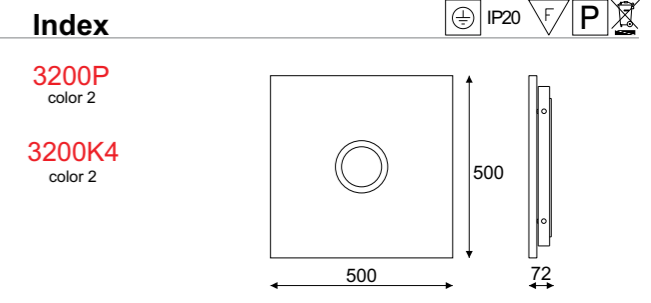

Obraz oko symetryczne - wersja duża
Paiting symmetric eye - large version

-  2G7 2x 11W, 230V, 50Hz 3200P
- electronic ballast color 2
-  LED ECO 18W, 1746lm, 3000K / 4000K 3200K4
- color 2



Obraz oko symetryczne - wersja średnia
Paiting symmetric eye - medium version

-  2G7 2x 11W, 230V, 50Hz 3160P
- electronic ballast color 2
-  LED ECO 18W, 1746lm, 3000K / 4000K 3160K4
- color 2

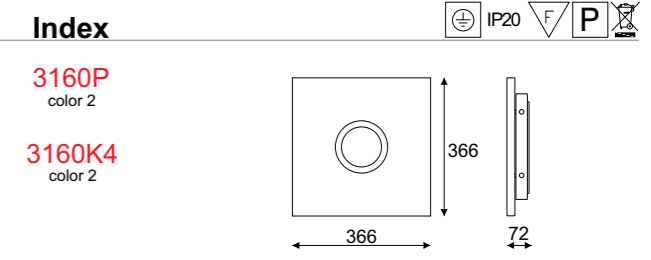

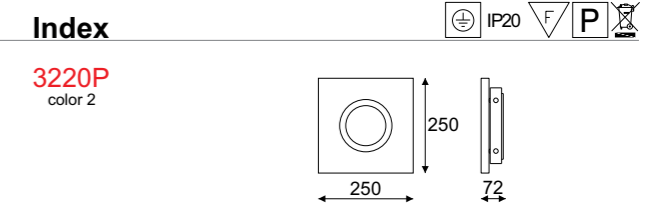

Obraz oko symetryczne - wersja mała
Paiting symetric eye - small version

-  2G7 2x 11W, 230V, 50Hz 3220P
- electronic ballast color 2



Obraz kwadraty
Paiting square

-  2G7 2x 11W, 230V, 50Hz 3120P
- electronic ballast color 2
-  LED ECO 18W, 1746lm, 3000K / 4000K 3120K4
- color 2

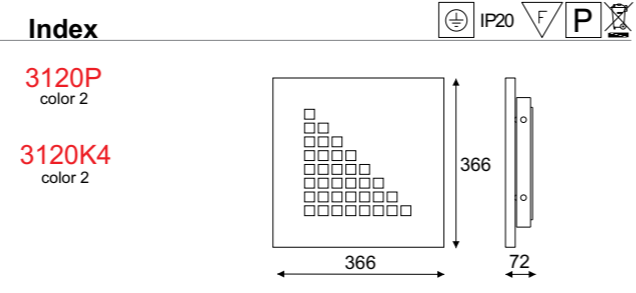

Spider



Spider wisząca / hanging lamp

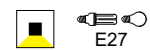

6x max 23W, 230V, 50Hz

Index

1325A6
color przewodu...
color drewna...3
color metalu...1

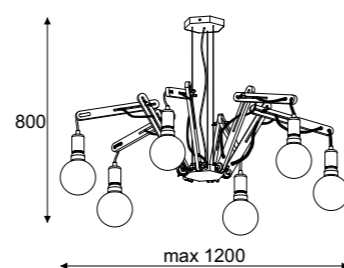
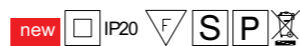

Spider kinkiet / wall lamp



1x max 60W, 230V, 50Hz

Index

1325K1
color przewodu...
color drewna...3
color metalu...1

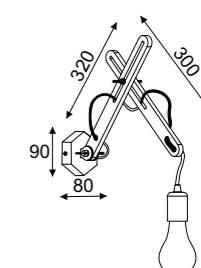
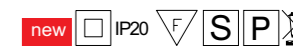

Avatar



Avatar 40 wisząca / hanging lamp



4x max 23W, 230V, 50Hz

Index

1172W41
color 3



25W, 2755lm, 3000K / 4000K

1172W4L2
color 3

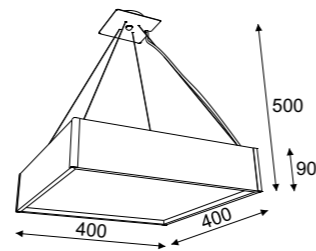
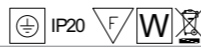

Avatar 50 wisząca / hanging lamp



4x max 23W, 230V, 50Hz

Index

1172W51
color 3



25W, 2755lm, 3000K / 4000K

1172W5L2
color 3

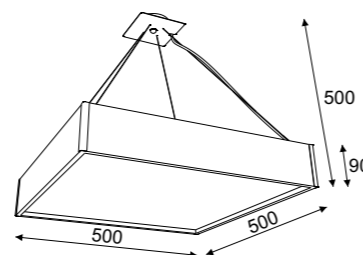
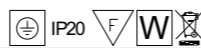

Avatar 40 kinkiet / wall lamp



1x max 23W, 230V, 50Hz

Index

1172K41
color 3



9W, 873lm, 3000K / 4000K

1172K4L5
color 3

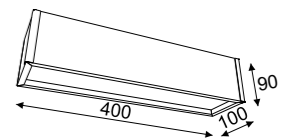

Avatar 50 kinkiet / wall lamp



2x max 23W, 230V, 50Hz

Index

1172K53
color 3



9W, 873lm, 3000K / 4000K

1172K5L5
color 3

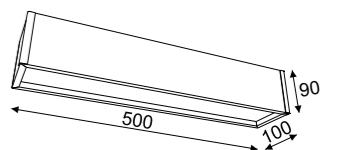

Avatar 40 plafon / ceiling lamp



3x max 23W, 230V, 50Hz

Index

1172P41
color 3



25W, 2755lm, 3000K / 4000K

1172P4L2
color 3

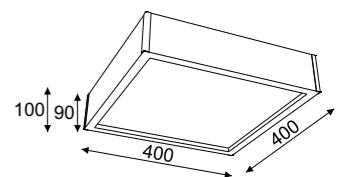

Avatar 50 plafon / ceiling lamp



3x max 23W, 230V, 50Hz

Index

1172P51
color 3



25W, 2755lm, 3000K / 4000K

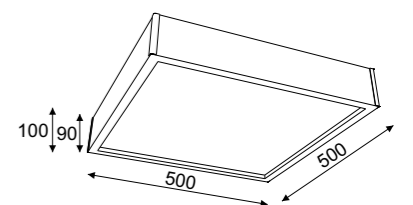

1172P5L2
color 3



Alma



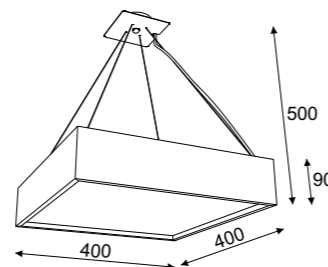
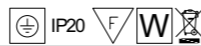

Alma 40 wisząca / hanging lamp

| | | |
|--|----------------------------|----------------------------|
|  | 4x max 23W, 230V, 50Hz | 1159W41 color 3 |
|  | 25W, 2755lm, 3000K / 4000K | 1159W4L2 color 3 |



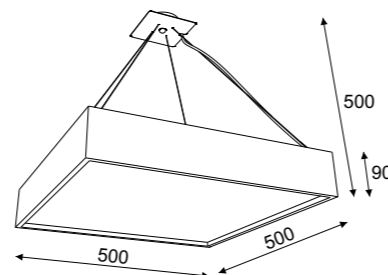
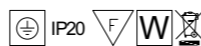

Alma 50 wisząca / hanging lamp

| | | |
|--|----------------------------|----------------------------|
|  | 4x max 23W, 230V, 50Hz | 1159W51 color 3 |
|  | 25W, 2755lm, 3000K / 4000K | 1159W5L2 color 3 |



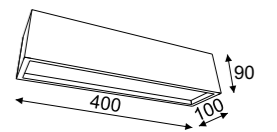

Alma 40 kinkiet / wall lamp

| | | |
|---|--------------------------|----------------------------|
|  | 1x max 23W, 230V, 50Hz | 1159K41 color 3 |
|  | 9W, 873lm, 3000K / 4000K | 1159K4L5 color 3 |



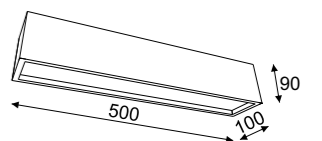

Alma 50 kinkiet / wall lamp

| | | |
|---|--------------------------|----------------------------|
|  | 2x max 23W, 230V, 50Hz | 1159K53 color 3 |
|  | 9W, 873lm, 3000K / 4000K | 1159K5L5 color 3 |



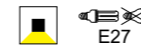

Alma 40 plafon / ceiling lamp

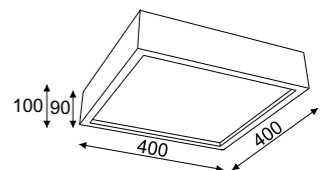
| | | |
|---|----------------------------|----------------------------|
|  | 3x max 23W, 230V, 50Hz | 1159P41 color 3 |
|  | 25W, 2755lm, 3000K / 4000K | 1159P4L2 color 3 |



Alma 50 plafon / ceiling lamp

| | | |
|---|----------------------------|----------------------------|
|  | 3x max 23W, 230V, 50Hz | 1159P51 color 3 |
|  | 25W, 2755lm, 3000K / 4000K | 1159P5L2 color 3 |

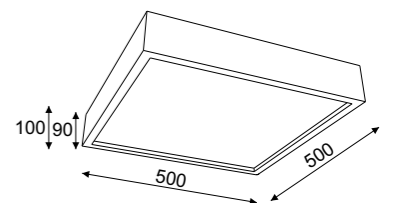
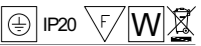



Oprawy z żywicy poliestrowej

Nowoczesny szyk i nieszablonowość.

Wyjątkowo wytrzymałe, nowoczesnie zaprojektowane, łatwe do utrzymania w czystości. To właśnie cechy naszych opraw oświetleniowych wykonanych z żywicy poliestrowej. Wspaniale wyglądają w pomieszczeniach, w których minimalistyczny styl przeplata się z dbałością o wszelkie, najdrobniejsze nawet detale. Oprawy te malowane są po stronie zewnętrznej farbami o wysokim połysku, wewnątrz natomiast pokrywamy je farbami metalicznymi. Połączenie to jest niezwykle efektowne, co doceniają przede wszystkim ci, którzy lubią odejść czasem od klasycznych sprawdzonych rozwiązań.

Lamps made of polyester resin

Modern chic and unique nature.

Extremely durable with a modern design and easy to keep clean. These are the features of our polyester resin luminaires. They look great in rooms where a minimalistic style is interwoven into even the tiniest details. These luminaires are painted with a high gloss paint on the exterior, while the interior is covered with metallic colours. This combination is extremely eye catching, and is primarily appreciated by those who like to sometimes step away from classic and well-known solutions.



Malowanie farbami metalicznymi

color 18 wew.



Oprawy lakierowane

color 9 / 11 zew.

Konfiguracje czasz:

Adaja D **1292D**/ x / xx / color 18 / color 9, 11

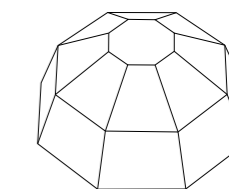
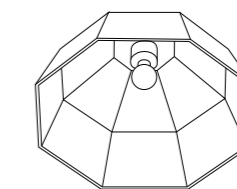

Ofelia D **1249D**/ x / xx / color 18 / color 9, 11

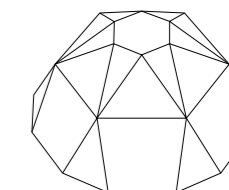
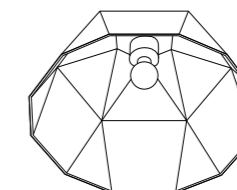

Ebro D **1248D**/ x / xx / color 18 / color 9, 11

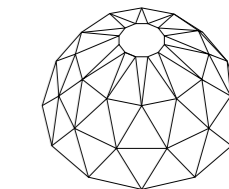
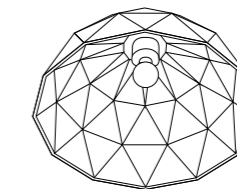

Wielkości czasz: x

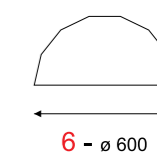
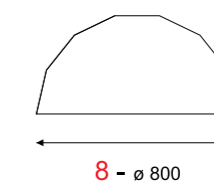
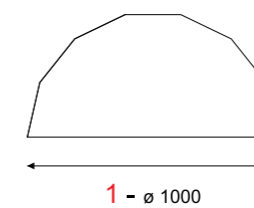

Źródła światła: xx



E27



Gu10

E - 1x max 23W, 230V, 50Hz

A - 1x max 40W, 230V, 50Hz

E - 1x max 23W, 230V, 50Hz

A - 1x max 40W, 230V, 50Hz

E - 1x max 23W, 230V, 50Hz

A - 1x max 40W, 230V, 50Hz

Kolor wewnętrzny: color 18



961 - Kolor miedzi



962 - Kolor złota



963 - Kolor srebra



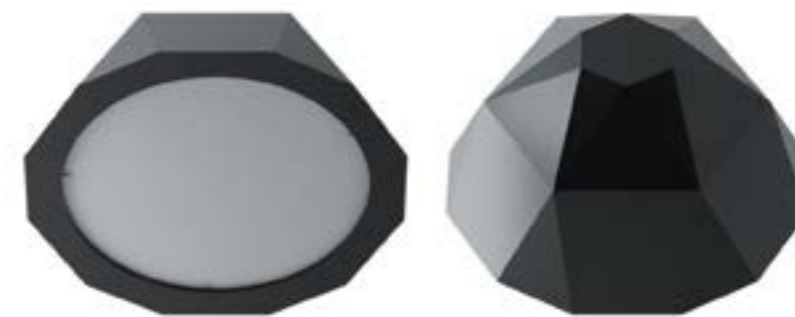

Oprawy lakierowane

color 9 / 11 zew.

Konfiguracje czasz:

Adaja A **1292A**/ x / xx / color 9, 11

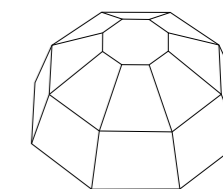
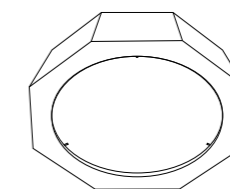

Ofelia A **1249A**/ x / xx / color 9, 11

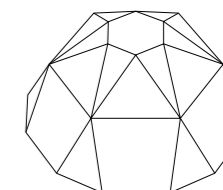
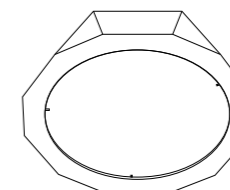

Ebro A **1248A**/ x / xx / color 9, 11

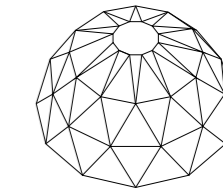
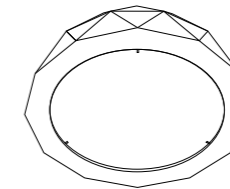

Wielkości czasz: x

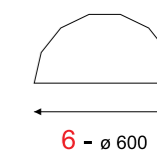
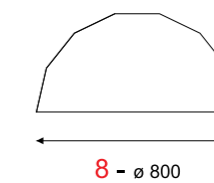
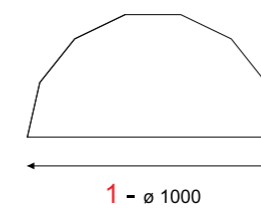

Źródła światła: xx



LED ECO

H - 6x max 23W, 230V, 50Hz

D - 3x 40W, 230V, 50Hz

D8 - 72W, 6998lm, 3000K
4000K

B - 4x max 23W, 230V, 50Hz

L - 3x 22W, 230V, 50Hz

D8 - 72W, 6998lm, 3000K
4000K

C - 3x max 23W, 230V, 50Hz

M - 1x 40W, 230V, 50Hz

L2 - 25W, 2755lm, 3000K
4000K



Etna D plafon / ceiling lamp

| | | Index | Index |
|--|----------------------------|------------------------------|---------------------------------|
| | 10x E27, 230V, 50Hz | 1329DEB biały mat | 1329DED do malowania |
| | 4x 21W, 230V, 50Hz | 1329DTB biały mat | 1329DTD do malowania |
| | 4x 39W, 230V, 50Hz | 1329DKB biały mat | 1329DKD do malowania |
| | 90W, 8748lm, 3000K / 4000K | 1329DK1B biały mat | 1329DK1D do malowania |

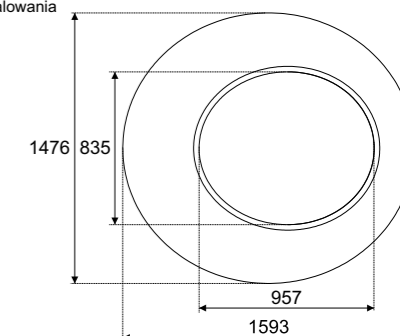
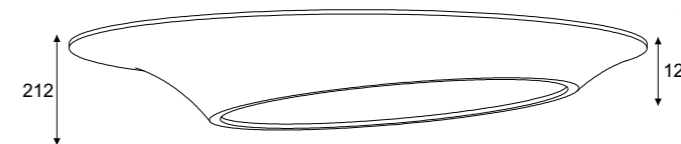

Oprawa oświetleniowa dostępna w kolorze „biały mat” oraz w stanie surowym do samodzielnego malowania na dowolny kolor

Etna S plafon / ceiling lamp

| | | Index | Index |
|--|----------------------------|------------------------------|---------------------------------|
| | 8x E27, 230V, 50Hz | 1329SRB biały mat | 1329SRD do malowania |
| | 4x 14W, 230V, 50Hz | 1329SUB biały mat | 1329SUD do malowania |
| | 4x 24W, 230V, 50Hz | 1329SPB biały mat | 1329SPD do malowania |
| | 72W, 6998lm, 3000K / 4000K | 1329SD8B biały mat | 1329SD8D do malowania |

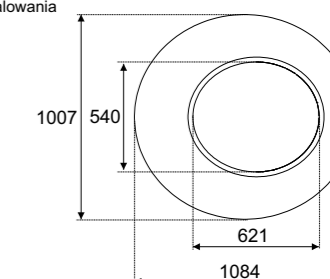
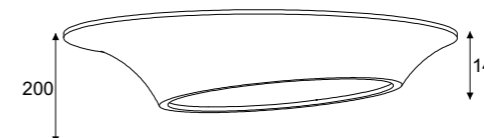

Oprawa oświetleniowa dostępna w kolorze „biały mat” oraz w stanie surowym do samodzielnego malowania na dowolny kolor

Etna M plafon / ceiling lamp

| | | Index | Index |
|--|----------------------------|------------------------------|---------------------------------|
| | 5x E27, 230V, 50Hz | 1329MYB biały mat | 1329MYD do malowania |
| | 2x 24W, 230V, 50Hz | 1329MNB biały mat | 1329MND do malowania |
| | 36W, 3492lm, 3000K / 4000K | 1329MD1B biały mat | 1329MD1D do malowania |
| | 1x 40W, 230V, 50Hz | 1329MSB biały mat | 1329MSD do malowania |

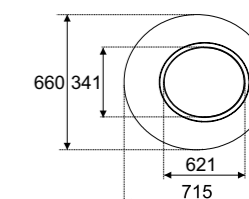

Oprawa oświetleniowa dostępna w kolorze „biały mat” oraz w stanie surowym do samodzielnego malowania na dowolny kolor

Oprawy oświetleniowe loftowe

Wielkomiejski styl, industrialny charakter.

Absolutnym hitem ostatnich lat jest industrialny styl wykończenia wnętrz. Szczególnie dobrze odnajduje się on w przestronnych, loftowych mieszkaniach. My postanowiliśmy wyjść naprzeciw temu coraz bardziej popularnemu trendowi, tworząc kolekcję lamp, które w fantastyczny sposób dopełniają wielkomiejski wystrój danej przestrzeni i podkreślają jej niebanalny charakter. Dzięki naszym lampom loftowym zachowany zostaje surowy styl wnętrza, jednocześnie nie wykluczając wrażenia przytulności, które regulować można wyborem konkretnej oprawy oświetleniowej.

Loft lamps

Urban style, industrial character.

An absolute highlight of recent years is the rise of industrial style interiors, especially well suited for spacious lofts. We decided to meet this increasingly popular trend by creating a collection of lamps which fit urban design spaces fantastically while still emphasizing their original character. Thanks to our loft lamp, the raw style of the interior is maintained without losing a sense of coziness, which can be adjusted by choosing certain luminaires.



Avantador

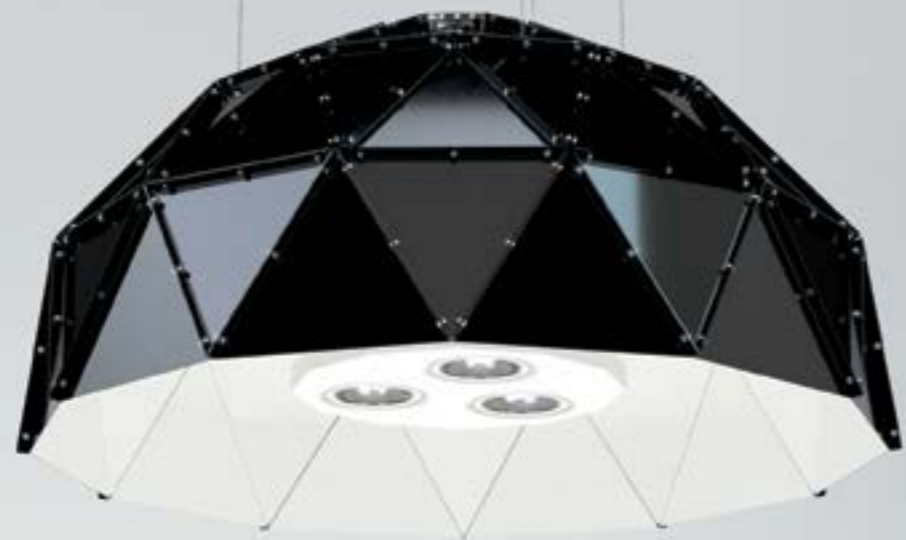

Avantador

1083 / x / xx / xxx / color 1

Wielkość czaszy - x



A08 - ø80

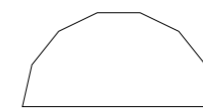

A10 - ø1000

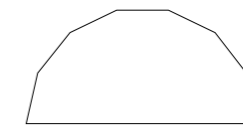

A12 - ø1250

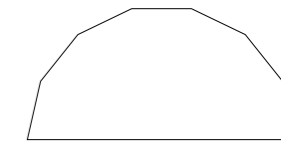

A15 - ø1500

Źródło światła - xx

C06L2

LEDECOV

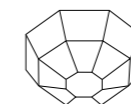

LED 25W, 2755lm, 3000K, 4000K

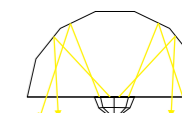

C07

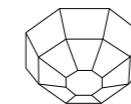

2 x E27

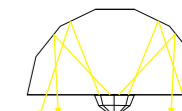

C08

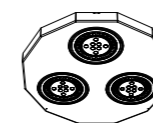

3 x AR 111, AC, LED / halogen + E14

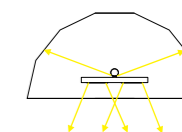

C09

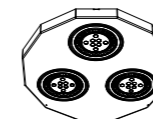

3 x AR 111, DC, LED

+ E14

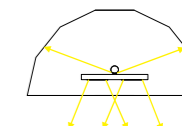

Rodzaje zawiesia - xxx

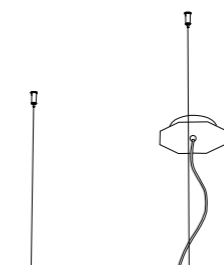

B05

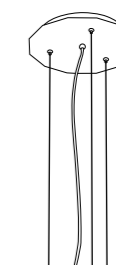

B04

Hayate

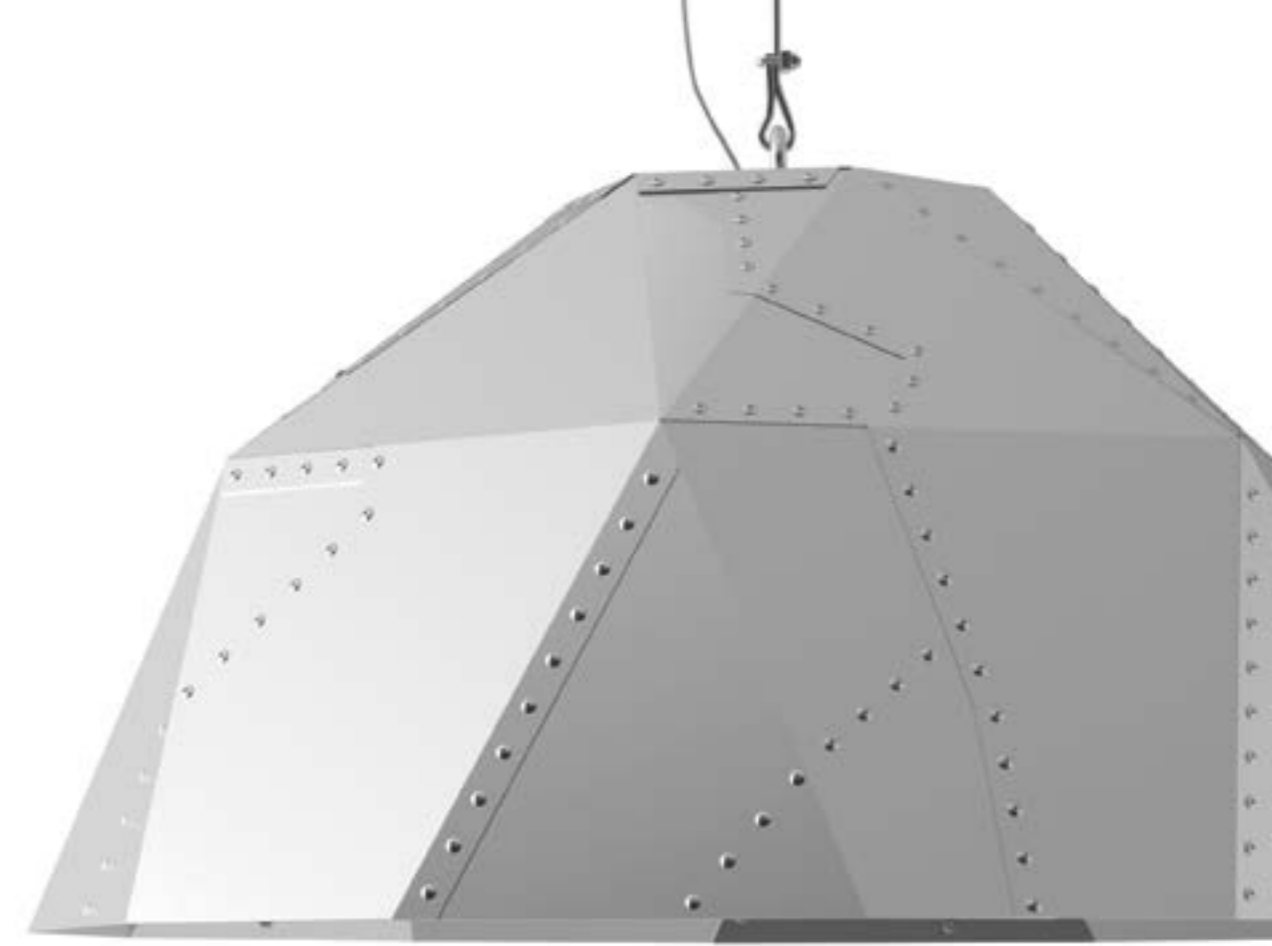

Hayate 60 wisząca / hanging lamp



1x max 60W, 230V, 50Hz

Index

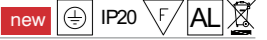

1262A3
Color 1, 5

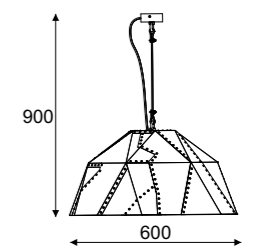

Hayate 80 wisząca / hanging lamp



1x max 60W, 230V, 50Hz

Index

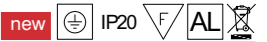

1262A2
Color 1, 5

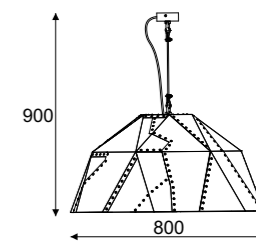

Hayate 100 wisząca / hanging lamp



1x max 60W, 230V, 50Hz

Index

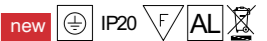

1262A1
Color 1, 5

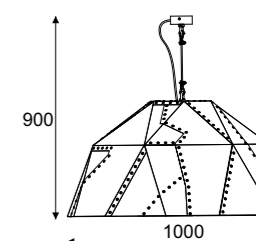

Hayate



Hayate plafon / ceiling lamp

Index



2x max 60W, 230V, 50Hz

1262C1
Color 1, 5

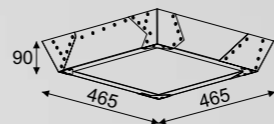
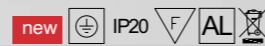

Hayate

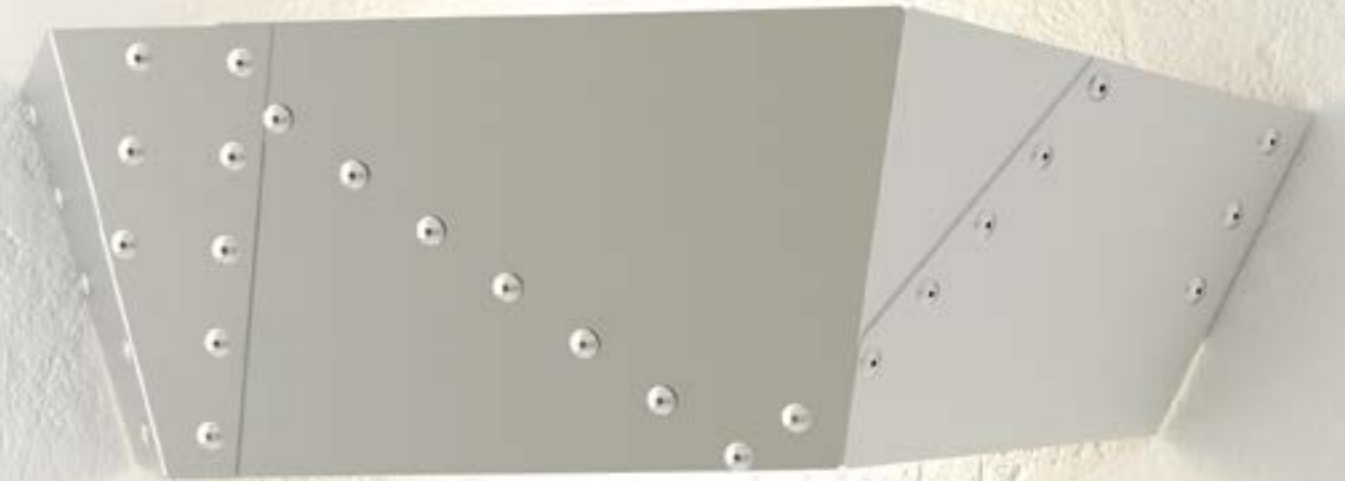

Hayate kinkiet / wall lamp

Index

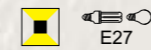

1x max 60W, 230V, 50Hz

1262B1
Color 1, 5

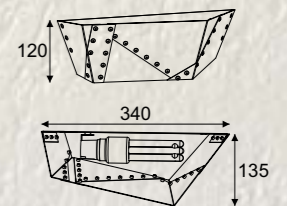
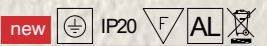



Nambino wisząca / hanging lamp

Index

new IP20 F S



1x max 60W, 230V, 50Hz

1337A1
color przewodu...
color 1... (czasza na zewnątrz, podsufitka)

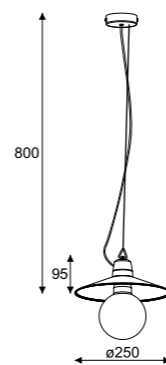

1x max 60W, 230V, 50Hz

1337A2
color przewodu...
color 15...(czasza na zewnątrz i wewnątrz, podsufitka)

Bernini wisząca / hanging lamp

Index

new IP20 F S



1x max 60W, 230V, 50Hz

1338A1
color przewodu...
color 1... (czasza na zewnątrz, podsufitka)

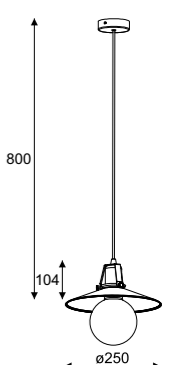

1x max 60W, 230V, 50Hz

1338A2
color przewodu...
color 15...(czasza na zewnątrz i wewnątrz, podsufitka)

Nambino wisząca / hanging lamp

Index

new IP20 F S

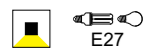

1x max 60W, 230V, 50Hz

1341B1
color przewodu...
color 1... (czasza na zewnątrz, podsufitka)

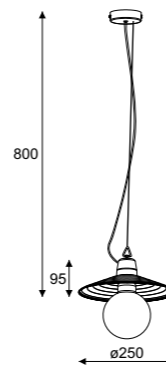

1x max 60W, 230V, 50Hz

1341B2
color przewodu...
color 15...(czasza na zewnątrz i wewnątrz, podsufitka)

Bernini wisząca / hanging lamp

Index

new IP20 F S



1x max 60W, 230V, 50Hz

1338B1
color przewodu...
color 1... (czasza na zewnątrz, podsufitka)

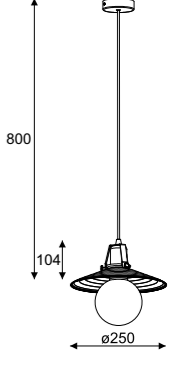

1x max 60W, 230V, 50Hz

1338B2
color przewodu...
color 15...(czasza na zewnątrz i wewnątrz, podsufitka)



Loreto E1A

new IP20 F S

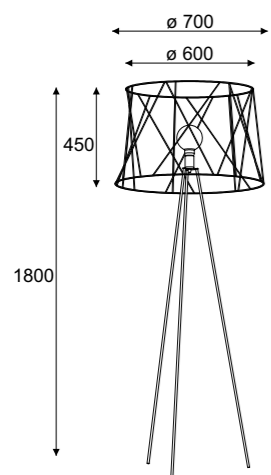

1x max 60W, 230V, 50Hz

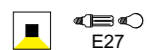

1331E1A
color 1

Loreto E1B

new IP20 F S

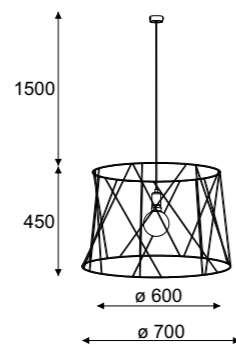

1x max 60W, 230V, 50Hz



1331E1B
color 1

Loreto E0C

new IP20 F S

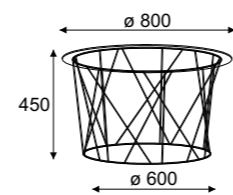

Konstrukcja bez blatu

1331E0C
color 1

Cumulus wisząca / hanging lamp



3x max 60W, 230V, 50Hz

Index

1334E3B
color przewodu... color 1

new IP20 F S

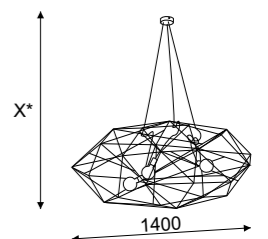

X* Wysokość lampy regulowana przewodami. Standardowa długość każdego przewodu to 1,5m.
Dłuższe przewody na życzenie klienta za dopłatą.

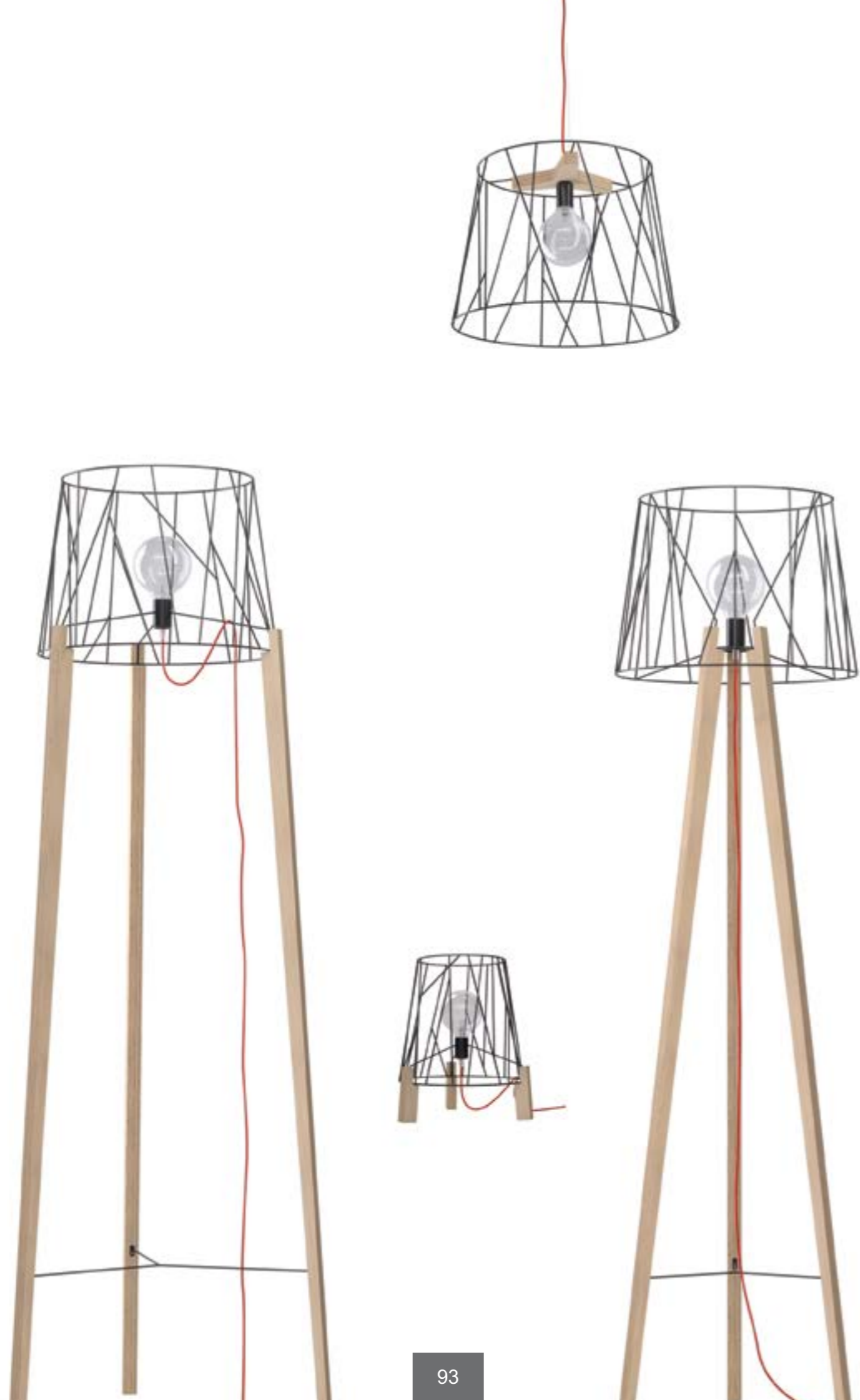

Bolardo A stojąca / hanging lamp



1x max 60W, 230V, 50Hz

Index

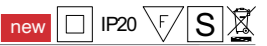

1357A1
 abażur color 1,6
 drewno color 2
 color przewodu

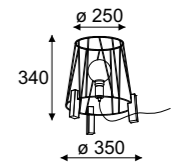

Bolardo C stojąca / hanging lamp



1x max 60W, 230V, 50Hz

Index

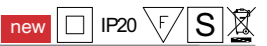

1357C1
 abażur color 1,6
 drewno color 2
 color przewodu

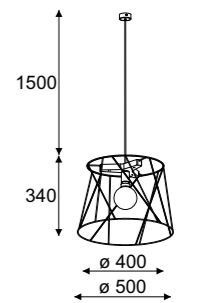

Bolardo B stojąca / hanging lamp



1x max 60W, 230V, 50Hz

Index

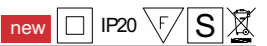

1357B1
 abażur color 1,6
 drewno color 2
 color przewodu

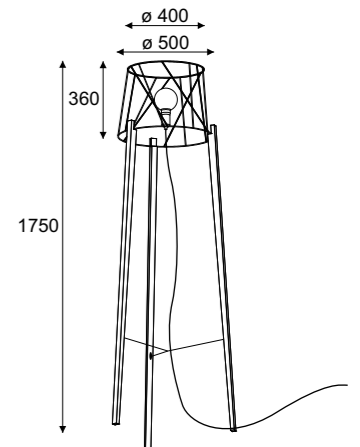

Bolardo D stojąca / hanging lamp



1x max 60W, 230V, 50Hz

Index

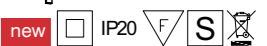

1357D1
 abażur color 1,6
 drewno color 2
 color przewodu

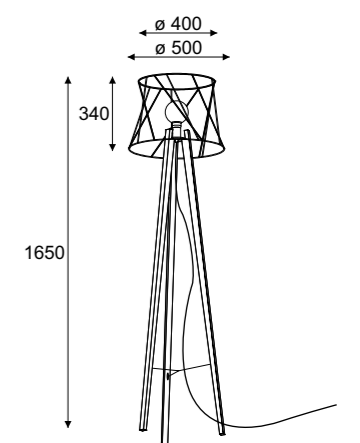

Anmore



Anmore wisząca / hanging lamp



1x max 60W, 230V, 50Hz

Index

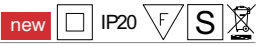

1217B1
color 1

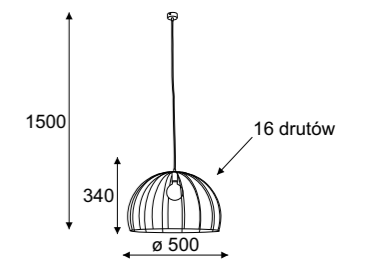

Anmore wisząca / hanging lamp



1x max 60W, 230V, 50Hz

Index

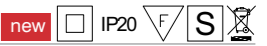

1217B2
color 1

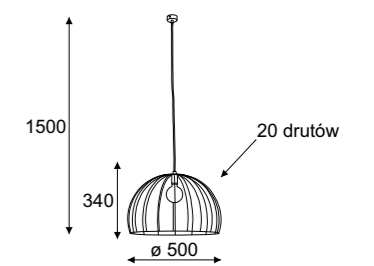

Anmore wisząca / hanging lamp



1x max 60W, 230V, 50Hz

Index

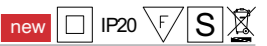

1217C1
color 1

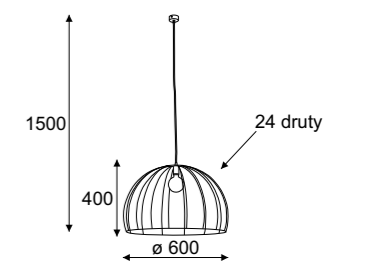

Anmore wisząca / hanging lamp



1x max 60W, 230V, 50Hz

Index

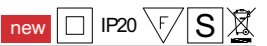

1217C2
color 1

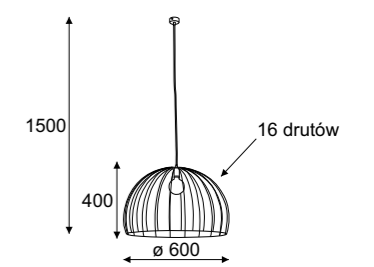

Anmore wisząca / hanging lamp



1x max 60W, 230V, 50Hz

Index

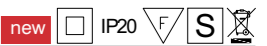

1217D1
color 1

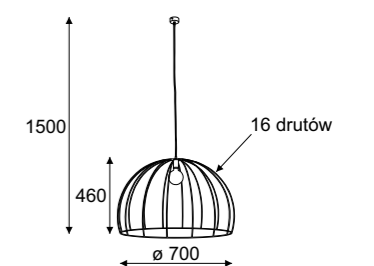

Anmore wisząca / hanging lamp



1x max 60W, 230V, 50Hz

Index

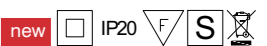

1217D2
color 1

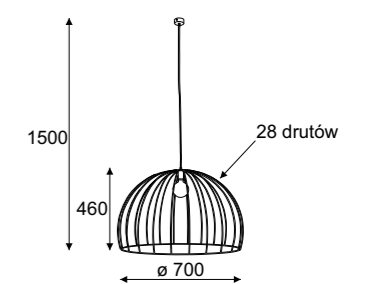

Anmore wisząca / hanging lamp



1x max 60W, 230V, 50Hz

Index



1217A1
color 1

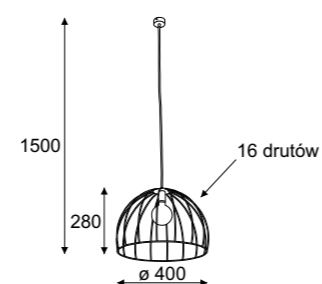



Batista 600 wisząca / hanging lamp



1x max 60W, 230V, 50Hz

Index

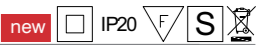

1339D1T
color przewodu...
color 15...
8...
6...
1...

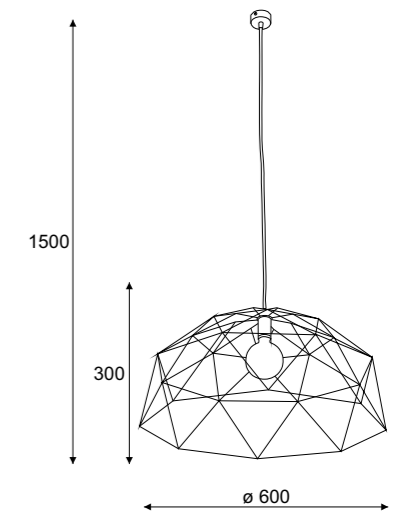

Batista 800 wisząca / hanging lamp



1x max 60W, 230V, 50Hz

Index

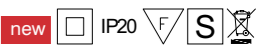

1339H1T
color przewodu...
color 15...
8...
6...
1...

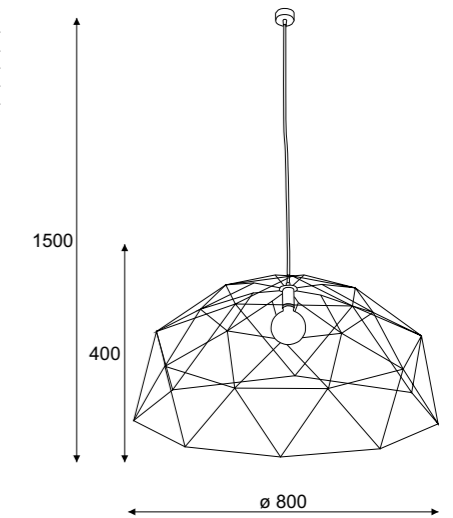

Batista 1000 wisząca / hanging lamp



1x max 60W, 230V, 50Hz

Index

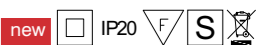

1339K1T
color przewodu...
color 15...
8...
6...
1...

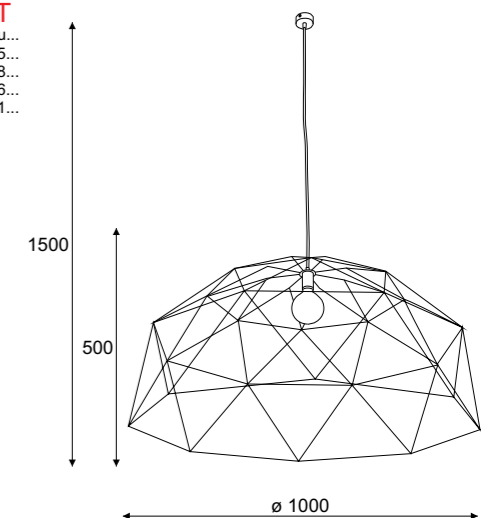

Diament



Diament 650 wisząca / hanging lamp



1x max 60W, 230V, 50Hz

Index

1356A1
color przewodu...
color 15...
8...
6...
1...

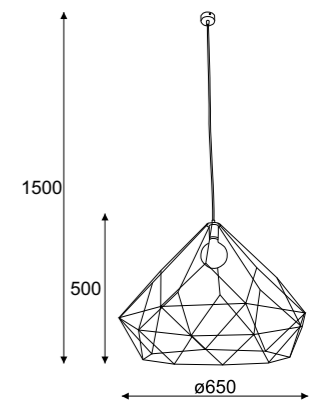
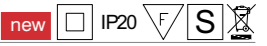

Diament 800 wisząca / hanging lamp



1x max 60W, 230V, 50Hz

Index

1356B1
color przewodu...
color 15...
8...
6...
1...

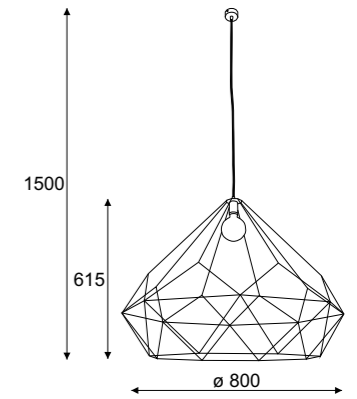
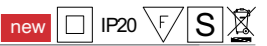

Diament 1000 wisząca / hanging lamp



1x max 60W, 230V, 50Hz

Index

1356C1
color przewodu...
color 15...
8...
6...
1...

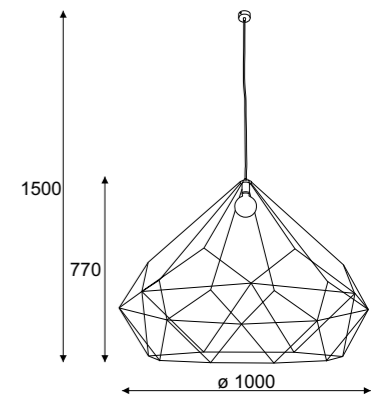
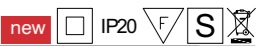

Azalea



Azalea wisząca / hanging lamp

Index

new IP20 F S

1x max 60W, 230V, 50Hz

1335A12
color przewodu...color 1

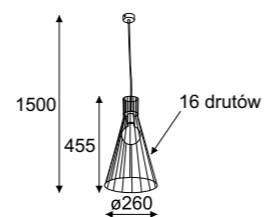

Azalea wisząca / hanging lamp

Index

new IP20 F S

1x max 60W, 230V, 50Hz

1335A24
color przewodu...color 1

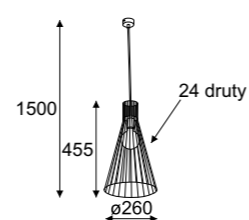

Azalea wisząca / hanging lamp

Index

new IP20 F S

1x max 60W, 230V, 50Hz

1335A32
color przewodu... color 1

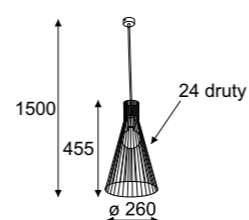

Braga



Braga wisząca / hanging lamp

Index

new IP20 F S

1x max 60W, 230V, 50Hz

1219A1
color 1

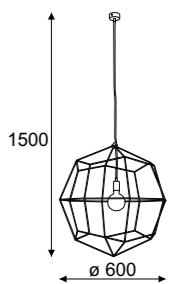

Beja



Beja wisząca / hanging lamp



1x max 60W, 230V, 50Hz

Index

1327B1
color 1

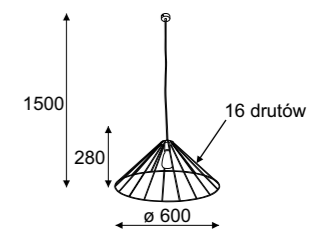
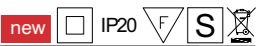

Beja wisząca / hanging lamp

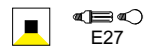

1x max 60W, 230V, 50Hz

Index

1327D1
color 1

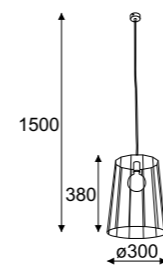

Beja wisząca / hanging lamp

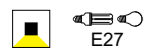

1x max 60W, 230V, 50Hz

Index

1327D2
color 1

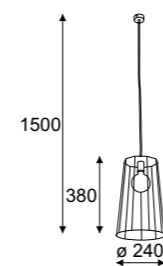

Beja wisząca / hanging lamp



1x max 60W, 230V, 50Hz

Index

1327B2
color 1

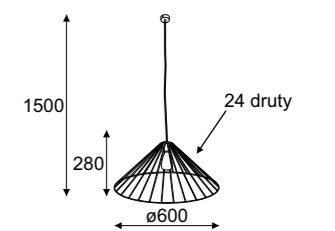
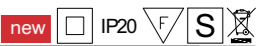



Beja wisząca / hanging lamp

new IP20 F S

1x max 60W, 230V, 50Hz

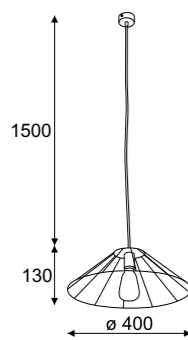

1327A1
color 1

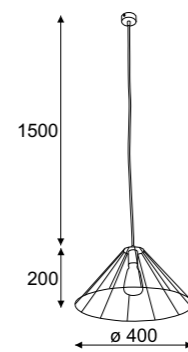

1327A2
color 1

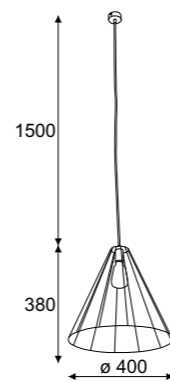

1327A3
color 1

Index



Rafi

Rafi wisząca / hanging lamp

new IP20 F S

1x max 60W, 230V, 50Hz

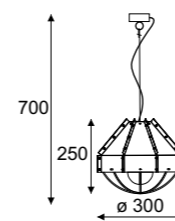

1299A1E
color 1/8

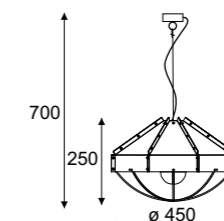

1299B1E
color 1/8

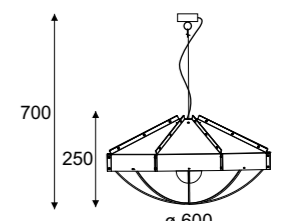

1299C1E
color 1/8

Index

Sorex



Monza



Sorex wisząca / hanging lamp

Index

new IP20 F S

1x max 60W, 230V, 50Hz

1202A1A
color 1/8

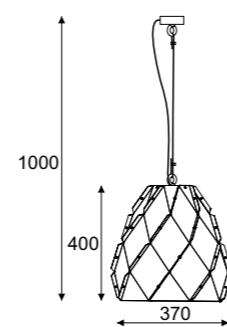
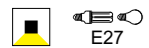

Monza wisząca / hanging lamp

Index

new IP20 F S

1x max 60W, 230V, 50Hz

1215Z1
color 1/8

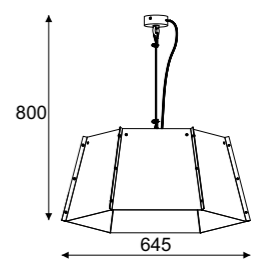

Malaga



Malaga wisząca / hanging lamp

Index

new IP20 F S

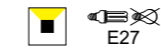

3x max 60W, 230V, 50Hz

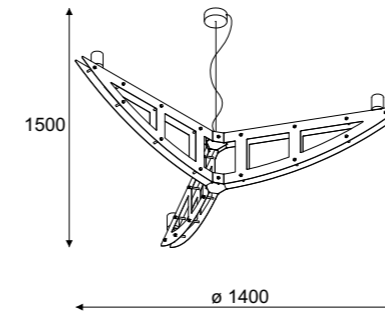

Index

1216A3
color 1/8

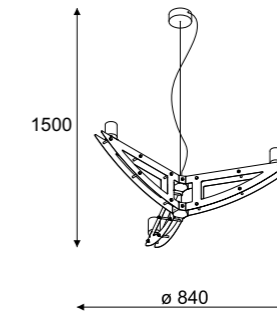

1216B3
color 1/8

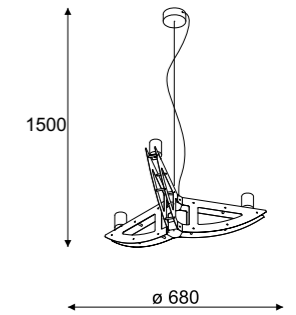

1216C3
color 1/8

Malaga wisząca / hanging lamp

Index

new IP20 F S



4x max 60W, 230V, 50Hz

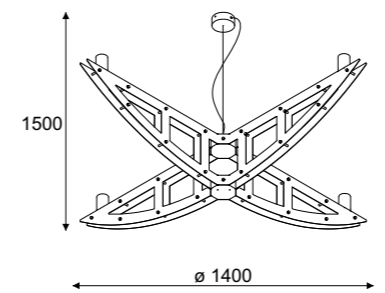

Index

1216A4
color 1/8

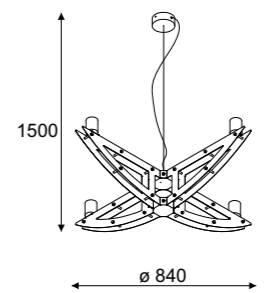

1216B4
color 1/8

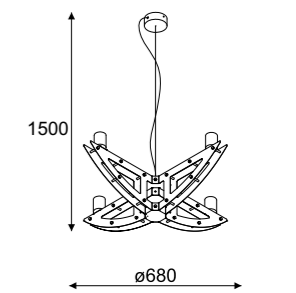

1216C4
color 1/8

Malaga wisząca / hanging lamp

Index

new IP20 F S



5x max 60W, 230V, 50Hz

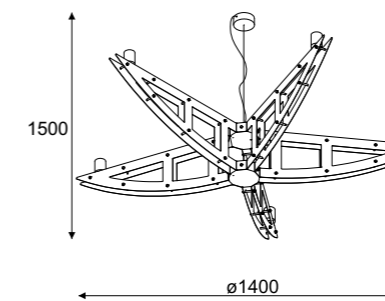

Index

1216A5
color 1/8

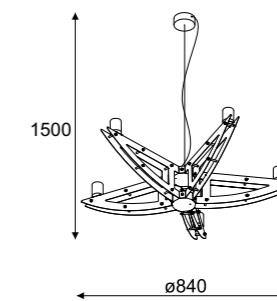

1216B5
color 1/8

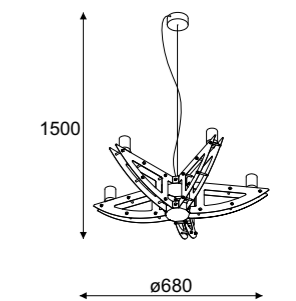

1216C5
color 1/8

Oprawy z metalu

Zachwycająca różnorodność

Do wykonania metalowych opraw oświetleniowych wykorzystujemy malowaną proszkowo stal bądź w ten sam sposób aluminium. Oba materiały dostępne są w niezwykle szerokiej palecie barw - jako jedna z nielicznych firm w Polsce proponujemy bowiem swoim klientom możliwość wyboru spośród niemalże aż 100 kolorów RAL. Oprawy aluminiowe oferujemy także w wersjach: anodowanej, pokrytej powłokami galwanicznymi typu chrom lub miedź oraz polerowanej, a następnie powleczonej bezbarwnym lakierem. Tego typu stylistyka doskonale wpisuje się we wnętrza pełne nowoczesnej elegancji.

Luminaires made of metal

The stunning diversity

To make metal luminaires, we use powder-coated steel or dyed aluminium. Both materials are available in a very wide range of colours. Our customers can choose from as many as nearly 100 RAL colours. We are actually one of few companies in Poland that can offer such a wide range of options. We also offer other types of aluminium fixtures: anodized, coated, coated with galvanic coatings like chromium or copper, or polished and coated with clear varnish. This type of design perfectly fits the ambience of modern elegance.

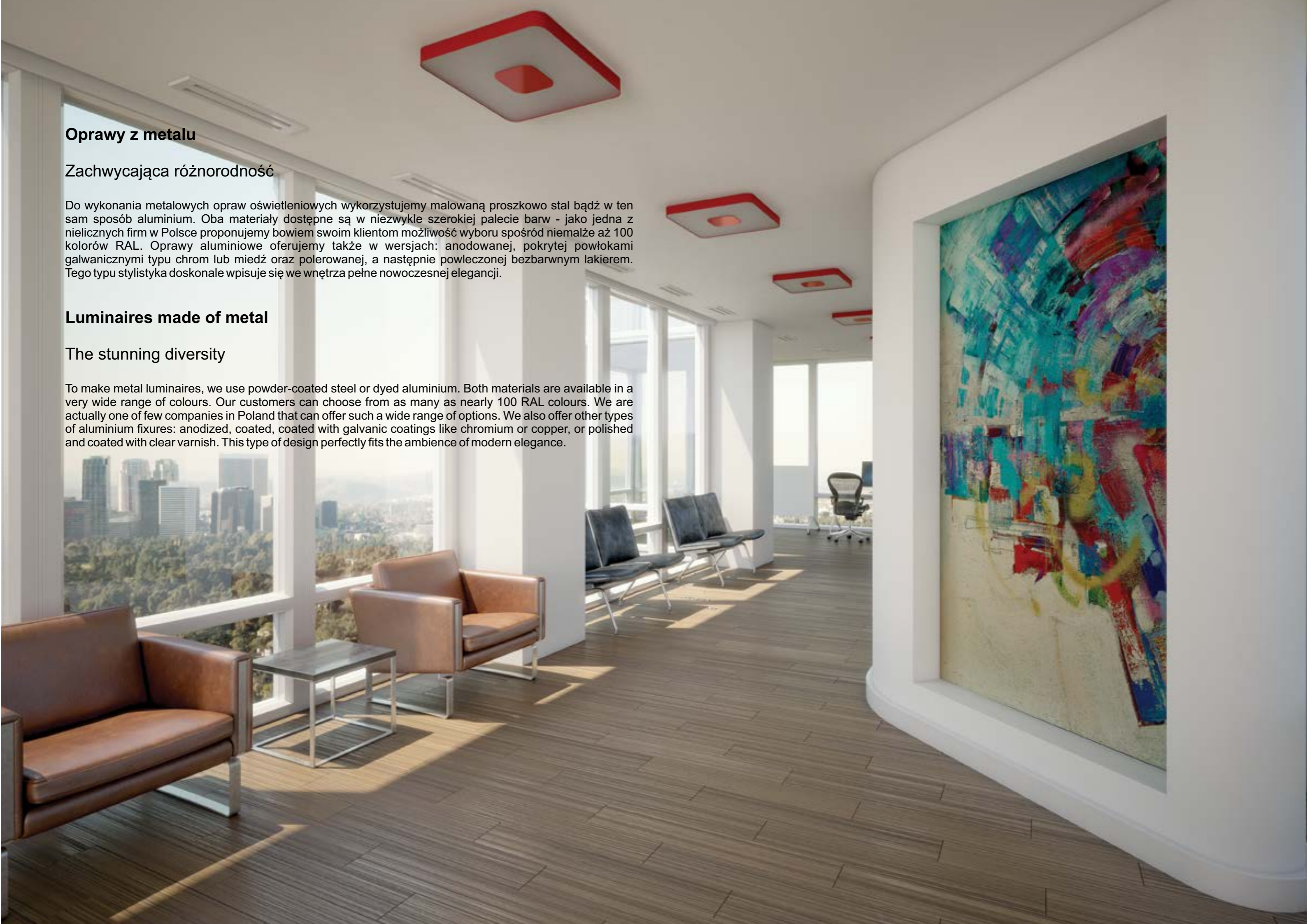

Wektor



Wektor 1233 wisząca / hanging lamp



G9

4x max 40W, 230V, 50Hz

Index

1233AGDW
color 1



LED ECO

25W, 2755lm, 3000K / 4000K

1233AL2DW
color 1



Kryształy duże

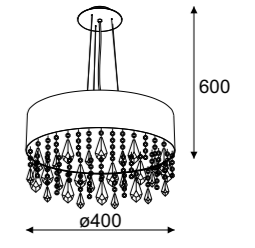

G9

4x max 40W, 230V, 50Hz

1233AGMW
color 1



LED ECO

25W, 2755lm, 3000K / 4000K

1233AL2MW
color 1



Kryształy małe

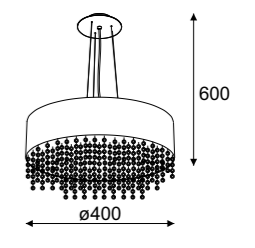

Wektor 1233 wisząca / hanging lamp



G9

5x max 40W, 230V, 50Hz

Index

1233BGDW
color 1



LED ECO

25W, 2755lm, 3000K / 4000K

1233BL2DW
color 1



Kryształy duże

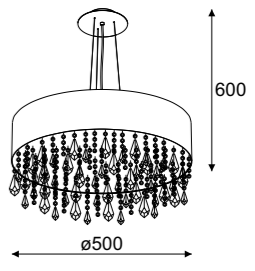

G9

5x max 40W, 230V, 50Hz

1233BGMW
color 1



LED ECO

25W, 2755lm, 3000K / 4000K

1233BL2MW
color 1



Kryształy małe

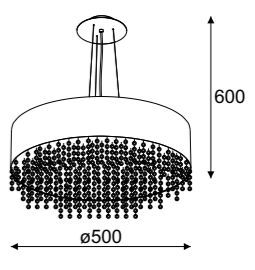

Wektor 1233 wisząca / hanging lamp



G9

5x max 40W, 230V, 50Hz

Index

1233CGDW
color 1



LED ECO

75W, 8265lm, 3000K / 4000K

1233CD3DW
color 1



Kryształy duże

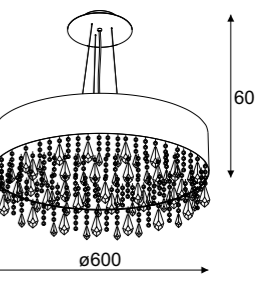

G9

5x max 40W, 230V, 50Hz

1233CGMW
color 1



LED ECO

75W, 8265lm, 3000K / 4000K

1233CD3MW
color 1



Kryształy małe

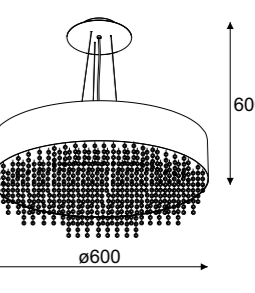

Wektor



Wektor 1233 plafon / ceiling lamp



G9

4x max 40W, 230V, 50Hz

Index

1233AGDP
color 1



LED ECO

25W, 2755lm, 3000K / 4000K

1233AL2DP
color 1



Kryształy duże

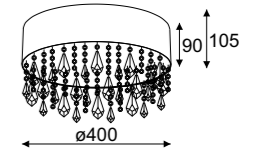

G9

4x max 40W, 230V, 50Hz

1233AGMP
color 1



LED ECO

25W, 2755lm, 3000K / 4000K

1233AL2MP
color 1



Kryształy małe

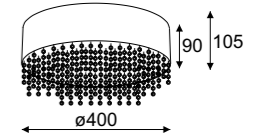

Wektor 1233 plafon / ceiling lamp



G9

5x max 40W, 230V, 50Hz

Index

1233BGDP
color 1



LED ECO

25W, 2755lm, 3000K / 4000K

1233BL2DP
color 1



Kryształy duże

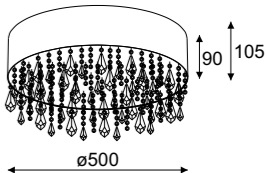

G9

5x max 40W, 230V, 50Hz

1233BGMP
color 1



LED ECO

25W, 2755lm, 3000K / 4000K

1233BL2MP
color 1



Kryształy małe

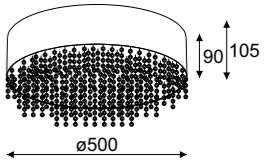

Wektor 1233 plafon / ceiling lamp



G9

5x max 40W, 230V, 50Hz

Index

1233CGDP
color 1



LED ECO

75W, 8265lm, 3000K / 4000K

1233CD3DP
color 1



Kryształy duże

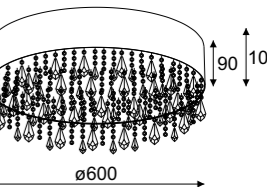

G9

5x max 40W, 230V, 50Hz

1233CGMP
color 1



LED ECO

75W, 8265lm, 3000K / 4000K

1233CD3MP
color 1



Kryształy małe

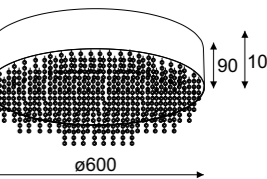



Aba 300 plafon / ceiling lamp

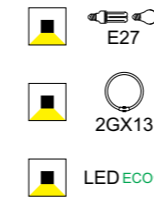

| Index |
|---|
| 2x max 23W, 230V, 50Hz 1267PA19E2 color 1 |
| 1x 22W, 230V, 50Hz PB3AT1 color 1 |
| 19W, 2066lm, 3000K / 4000K 1267PA1AL1 color 1 |

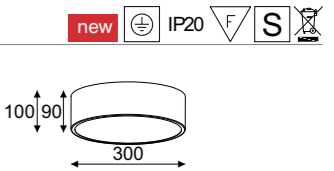

Aba 350 plafon / ceiling lamp



| Index |
|---|
| 2x max 23W, 230V, 50Hz 1267PA5AE2 color 1 |
| 1x 22W, 230V, 50Hz 1267PA5AT1 color 1 |
| 19W, 2066lm, 3000K / 4000K 1267PA5AL1 color 1 |

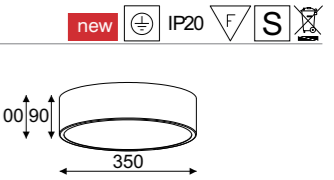

Aba 400 plafon / ceiling lamp

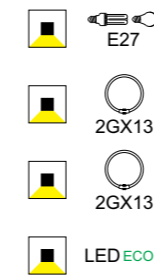

| Index |
|---|
| 3x max 23W, 230V, 50Hz 1267PB1AE3 color 1 |
| 1x 40W, 230V, 50Hz 1267PB1AT2 color 1 |
| 1x 55W, 230V, 50Hz 1267PB1AT3 color 1 |
| 25W, 2755lm, 3000K / 4000K 1267PB1AL2 color 1 |

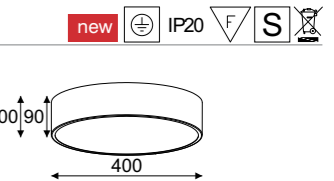

Aba 500 plafon / ceiling lamp

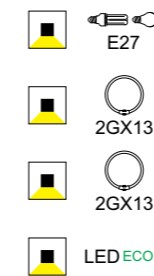

| Index |
|---|
| 4x max 23W, 230V, 50Hz 1267PCAE4 color 1 |
| 1x 40W, 230V, 50Hz 1267PC1AT2 color 1 |
| 1x 55W, 230V, 50Hz 1267PC1AT3 color 1 |
| 25W, 2755lm, 3000K / 4000K 1267PC1AL2 color 1 |

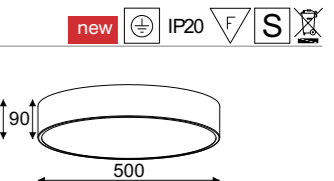

Aba 600 plafon / ceiling lamp

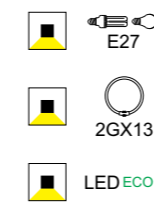

| Index |
|---|
| 5x max 23W, 230V, 50Hz 1267PDAE5 color 1 |
| 3x 22W, 230V, 50Hz 1267PD1AT1 color 1 |
| 75W, 8265lm, 3000K / 4000K 1267PD1AD3 color 1 |

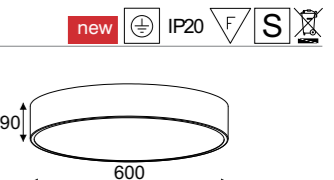

Aba 700 plafon / ceiling lamp

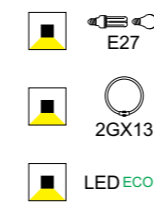

| Index |
|---|
| 5x max 23W, 230V, 50Hz 1267PE1AE5 color 1 |
| 4x 22W, 230V, 50Hz 1267PE1AT1 color 1 |
| 75W, 8265lm, 3000K / 4000K 1267PE1AD3 color 1 |

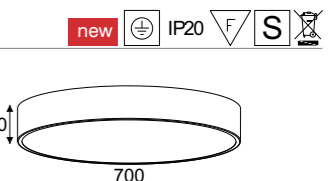



Aba 800 plafon / ceiling lamp

| | | Index |
|--|----------------------------|------------------------------|
| | 8x max 23W, 230V, 50Hz | 1267PH1AE8 color 1 |
| | 4x 22W, 230V, 50Hz | 1267PH1AT1 color 1 |
| | 4x 18W, 230V, 50Hz | 1267PH1AP1 color 1 |
| | 81W, 7857lm, 3000K / 4000K | 1267PH1AD2 color 1 |

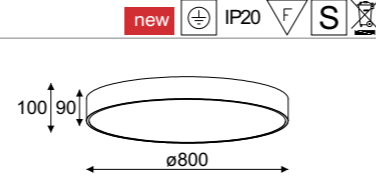

Aba 900 plafon / ceiling lamp

| | | Index |
|--|----------------------------|------------------------------|
| | 10x max 23W, 230V, 50Hz | 1267PK1AEL color 1 |
| | 4x 40W, 230V, 50Hz | 1267PK1AT2 color 1 |
| | 8x 24W, 230V, 50Hz | 1267PK1AP2 color 1 |
| | 81W, 7857lm, 3000K / 4000K | 1267PK1AD2 color 1 |

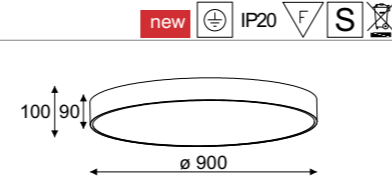

Aba 1000 plafon / ceiling lamp

| | | Index |
|--|------------------------------|------------------------------|
| | 12x max 23W, 230V, 50Hz | 1267PL1AEP color 1 |
| | 4x 40W, 230V, 50Hz | 1267PL1AT2 color 1 |
| | 8x 24W, 230V, 50Hz | 1267PL1AP2 color 1 |
| | 117W, 11349lm, 3000K / 4000K | 1267PL1AD5 color 1 |

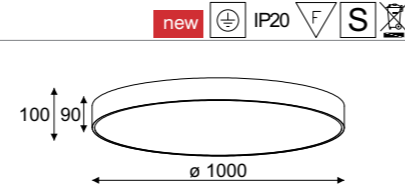

Aba 1100 plafon / ceiling lamp

| | | Index |
|--|------------------------------|------------------------------|
| | 12x max 23W, 230V, 50Hz | 1267PY1AEP color 1 |
| | 4x 40W, 230V, 50Hz | 1267PY1AT2 color 1 |
| | 8x 24W, 230V, 50Hz | 1267PY1AP2 color 1 |
| | 117W, 11349lm, 3000K / 4000K | 1267PY1AD5 color 1 |

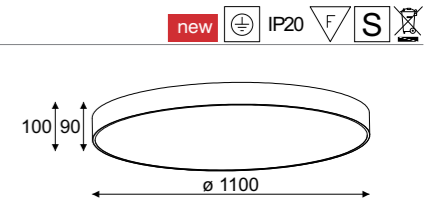

Aba 1200 plafon / ceiling lamp

| | | Index |
|--|------------------------------|------------------------------|
| | 14x max 23W, 230V, 50Hz | 1267PT1AER color 1 |
| | 7x 40W, 230V, 50Hz | 1267PT1AT2 color 1 |
| | 8x 36W, 230V, 50Hz | 1267PT1AP3 color 1 |
| | 135W, 13095lm, 3000K / 4000K | 1267PT1AD6 color 1 |

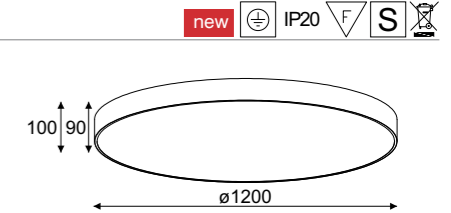

Aba 1300 plafon / ceiling lamp

| | | Index |
|--|------------------------------|------------------------------|
| | 14x max 23W, 230V, 50Hz | 1267PR1AER color 1 |
| | 7x 40W, 230V, 50Hz | 1267PR1AT2 color 1 |
| | 8x 36W, 230V, 50Hz | 1267PR1AP3 color 1 |
| | 135W, 13095lm, 3000K / 4000K | 1267PR1AD6 color 1 |

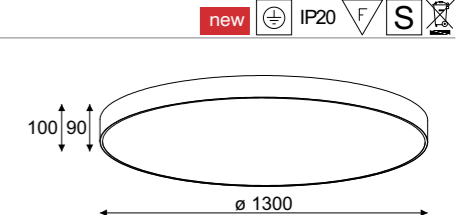

Aba 1400 plafon / ceiling lamp

| | | Index |
|--|------------------------------|------------------------------|
| | 16x max 23W, 230V, 50Hz | 1267PU1AET color 1 |
| | 8x 40W, 230V, 50Hz | 1267PU1AT2 color 1 |
| | 10x 36W, 230V, 50Hz | 1267PU1AP3 color 1 |
| | 216W, 20952lm, 3000K / 4000K | 1267PU1AD7 color 1 |

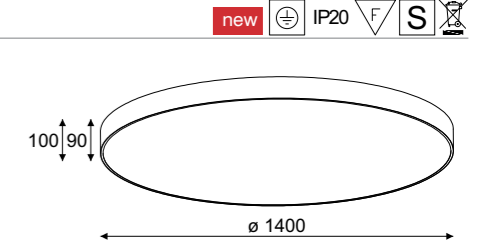

Aba 1500 plafon / ceiling lamp

| | | Index |
|--|------------------------------|------------------------------|
| | 16x max 23W, 230V, 50Hz | 1267PZ1AET color 1 |
| | 8x 40W, 230V, 50Hz | 1267PZ1AT2 color 1 |
| | 10x 36W, 230V, 50Hz | 1267PZ1AP3 color 1 |
| | 216W, 20952lm, 3000K / 4000K | 1267PZ1AD7 color 1 |

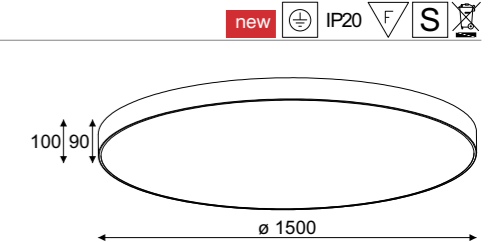

Aba 1600 plafon / ceiling lamp

| | | Index |
|--|------------------------------|------------------------------|
| | 16x max 23W, 230V, 50Hz | 1267PP1AET color 1 |
| | 8x 40W, 230V, 50Hz | 1267PP1AT2 color 1 |
| | 10x 36W, 230V, 50Hz | 1267PP1AP3 color 1 |
| | 216W, 20952lm, 3000K / 4000K | 1267PP1AD7 color 1 |

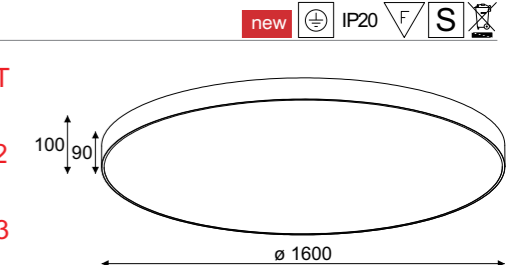



Aba 500 wisząca / hanging lamp

Index

new IP20 F S

| | | |
|--|------------------------------|------------------------------|
| | 4x max 23W, 230V, 50Hz | 1267ZCAE4 color 1 |
| | 1x 40W, 230V, 50Hz | 1267ZC1AT2 color 1 |
| | 1x 55W, 230V, 50Hz | 1267ZC1AT3 color 1 |
| | 25W, 2755lm, 3000°K / 4000°K | 1267ZC1AL2 color 1 |

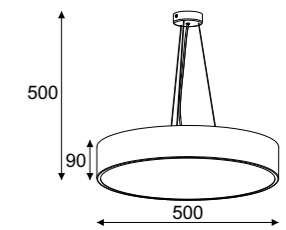

Aba 600 wisząca / hanging lamp

Index

new IP20 F S

| | | |
|--|------------------------------|------------------------------|
| | 5x max 23W, 230V, 50Hz | 1267ZD9E3 color 1 |
| | 3x 22W, 230V, 50Hz | 1267ZD1AT1 color 1 |
| | 75W, 8265lm, 3000°K / 4000°K | 1267ZD1AD3 color 1 |

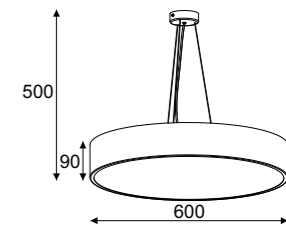

Aba 700 wisząca / hanging lamp

Index

new IP20 F S

| | | |
|--|------------------------------|------------------------------|
| | 5x max 23W, 230V, 50Hz | 1267ZEA5 color 1 |
| | 3x 22W, 230V, 50Hz | 1267ZE1AT1 color 1 |
| | 75W, 8265lm, 3000°K / 4000°K | 1267ZE1AD3 color 1 |

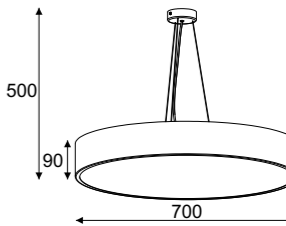

Aba 300 wisząca / hanging lamp

Index

new IP20 F S

| | | |
|--|----------------------------|------------------------------|
| | 2x max 23W, 230V, 50Hz | 1267ZA19E2 color 1 |
| | 1x 22W, 230V, 50Hz | 1267ZA1AT1 color 1 |
| | 19W, 2066lm, 3000K / 4000K | 1267ZA1AL1 color 1 |

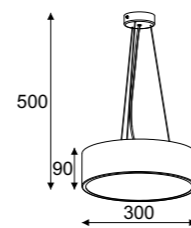

Aba 350 wisząca / hanging lamp

Index

new IP20 F S

| | | |
|--|----------------------------|------------------------------|
| | 2x max 23W, 230V, 50Hz | 1267ZA5AE2 color 1 |
| | 1x 22W, 230V, 50Hz | 1267ZA5AT1 color 1 |
| | 19W, 2066lm, 3000K / 4000K | 1267ZA5AL1 color 1 |

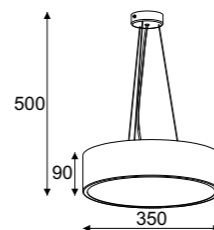

Aba 400 wisząca / hanging lamp

Index

new IP20 F S

| | | |
|--|----------------------------|------------------------------|
| | 3x max 23W, 230V, 50Hz | 1267ZB1AE3 color 1 |
| | 1x 40W, 230V, 50Hz | 1267ZB1AT2 color 1 |
| | 1x 55W, 230V, 50Hz | 1267ZB1AT3 color 1 |
| | 25W, 2755lm, 3000K / 4000K | 1267ZB1AL2 color 1 |

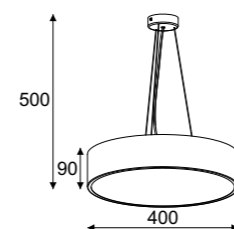

Aba 40 kinkiet / wall lamp

Index

new IP20 F S

| | | |
|--|--------------------------|------------------------------|
| | 1x max 23W, 230V, 50Hz | 1267KB1AE1 color 1 |
| | 9W, 873lm, 3000K / 4000K | 1267KB1AL5 color 1 |

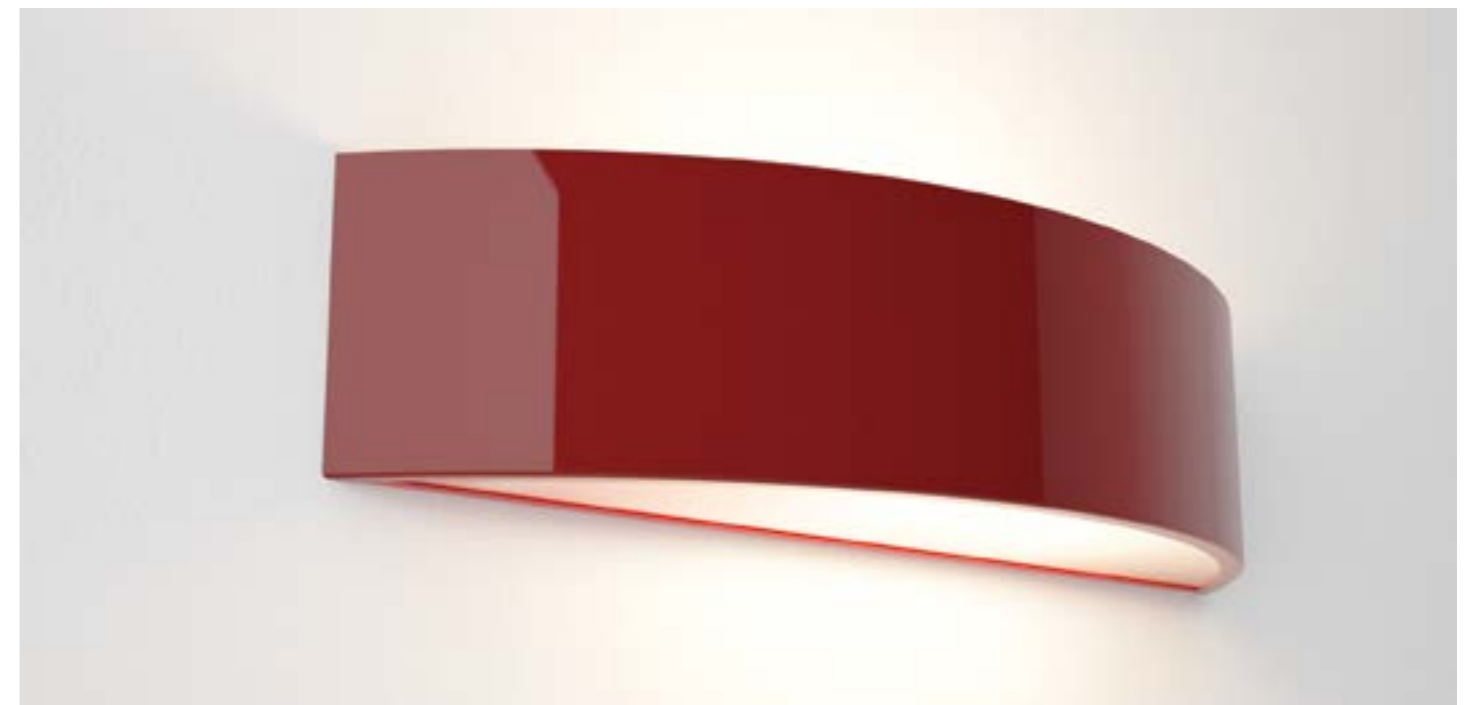
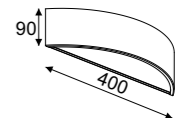



Aba 800 wisząca / hanging lamp

Index

new IP20 F S

| | | |
|--|----------------------------|------------------------------|
| | 8x max 23W, 230V, 50Hz | 1267ZH1AE8 color 1 |
| | 4x 22W, 230V, 50Hz | 1267ZH1AT1 color 1 |
| | 4x 18W, 230V, 50Hz | 1267ZH1AP1 color 1 |
| | 81W, 7857lm, 3000K / 4000K | 1267ZH1AD2 color 1 |

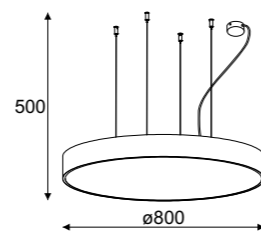

Aba 900 wisząca / hanging lamp

Index

new IP20 F S

| | | |
|--|----------------------------|------------------------------|
| | 10x max 23W, 230V, 50Hz | 1267ZK1AEL color 1 |
| | 4x 40W, 230V, 50Hz | 1267ZK1AT2 color 1 |
| | 8x 24W, 230V, 50Hz | 1267ZK1AP2 color 1 |
| | 81W, 7857lm, 3000K / 4000K | 1267ZK1AD2 color 1 |

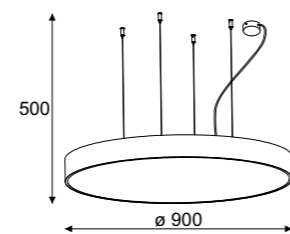

Aba 1000 wisząca / hanging lamp

Index

new IP20 F S

| | | |
|--|------------------------------|------------------------------|
| | 12x max 23W, 230V, 50Hz | 1267ZL1AEP color 1 |
| | 4x 40W, 230V, 50Hz | 1267ZL1AT2 color 1 |
| | 8x 24W, 230V, 50Hz | 1267ZL1AP2 color 1 |
| | 117W, 11349lm, 3000K / 4000K | 1267ZL1AD5 color 1 |

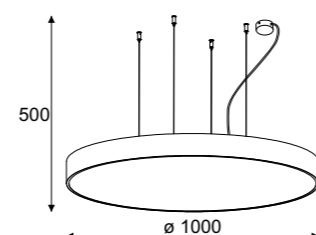

Aba 1100 wisząca / hanging lamp

Index

new IP20 F S

| | | |
|--|------------------------------|------------------------------|
| | 12x max 23W, 230V, 50Hz | 1267ZY1AEP color 1 |
| | 4x 40W, 230V, 50Hz | 1267ZY1AT2 color 1 |
| | 8x 24W, 230V, 50Hz | 1267ZY1AP2 color 1 |
| | 117W, 11349lm, 3000K / 4000K | 1267ZY1AD5 color 1 |

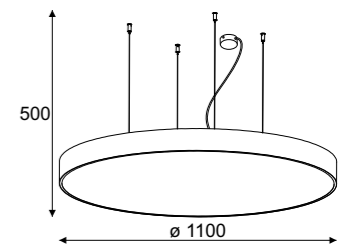

Aba 1200 wisząca / hanging lamp

Index

new IP20 F S

| | | |
|--|------------------------------|------------------------------|
| | 14x max 23W, 230V, 50Hz | 1267ZT1AER color 1 |
| | 7x 40W, 230V, 50Hz | 1267ZT1AT2 color 1 |
| | 8x 36W, 230V, 50Hz | 1267ZT1AP3 color 1 |
| | 135W, 13095lm, 3000K / 4000K | 1267ZT1AD6 color 1 |

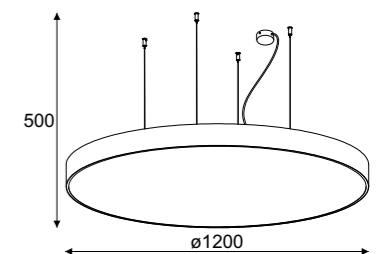

Aba 1300 wisząca / hanging lamp

Index

new IP20 F S

| | | |
|--|------------------------------|------------------------------|
| | 14x max 23W, 230V, 50Hz | 1267ZR1AER color 1 |
| | 7x 40W, 230V, 50Hz | 1267ZR1AT2 color 1 |
| | 8x 36W, 230V, 50Hz | 1267ZR1AP3 color 1 |
| | 135W, 13095lm, 3000K / 4000K | 1267ZR1AD6 color 1 |

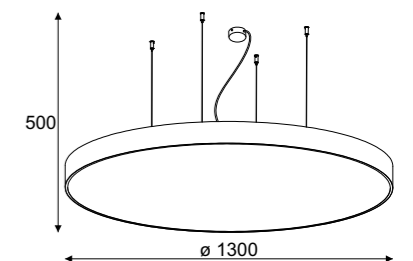

Aba 1400 wisząca / hanging lamp

Index

new IP20 F S

| | | |
|--|------------------------------|------------------------------|
| | 16x max 23W, 230V, 50Hz | 1267ZU1AET color 1 |
| | 8x 40W, 230V, 50Hz | 1267ZU1AT2 color 1 |
| | 10x 36W, 230V, 50Hz | 1267ZU1AP3 color 1 |
| | 216W, 20952lm, 3000K / 4000K | 1267ZU1AD7 color 1 |

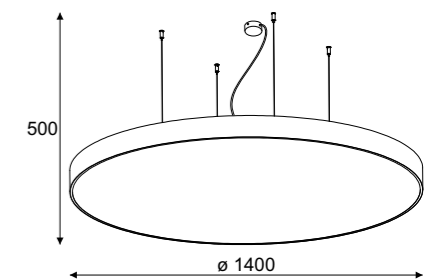

Aba 1500 wisząca / hanging lamp

Index

new IP20 F S

| | | |
|--|------------------------------|------------------------------|
| | 16x max 23W, 230V, 50Hz | 1267ZZ1AET color 1 |
| | 8x 40W, 230V, 50Hz | 1267ZZ1AT2 color 1 |
| | 10x 36W, 230V, 50Hz | 1267ZZ1AP3 color 1 |
| | 216W, 20952lm, 3000K / 4000K | 1267ZZ1AD7 color 1 |

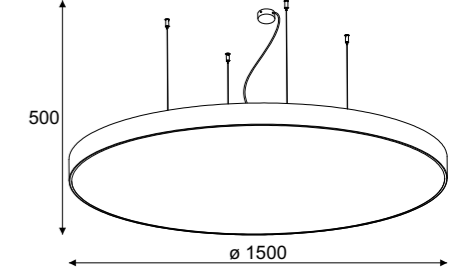

Aba 1600 wisząca / hanging lamp

Index

new IP20 F S

| | | |
|--|------------------------------|------------------------------|
| | 16x max 23W, 230V, 50Hz | 1267ZP1AET color 1 |
| | 8x 40W, 230V, 50Hz | 1267ZP1AT2 color 1 |
| | 10x 36W, 230V, 50Hz | 1267ZP1AP3 color 1 |
| | 216W, 20952lm, 3000K / 4000K | 1267ZP1AD7 color 1 |

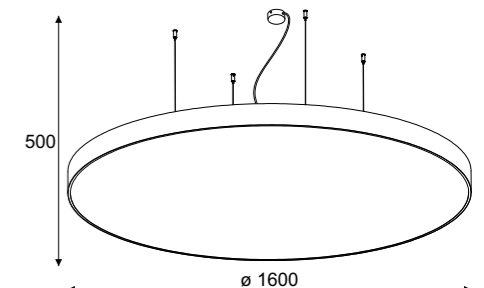

Carina



Carina 28 plafon / ceiling lamp



1x max 60W, 230V, 50Hz

Index

1158P6
color 1

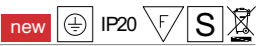

19W, 2066lm, 3000K / 4000K

1158P6L1
color 1

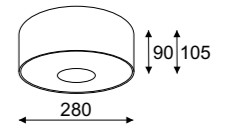

Carina 34 plafon / ceiling lamp



2x max 60W, 230V, 50Hz

Index

1158P7
color 1

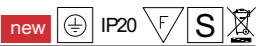

19W, 2066lm, 3000K / 4000K

1158P7L1
color 1

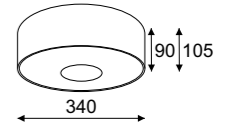

Carina 40 plafon / ceiling lamp



3x max 60W, 230V, 50Hz

Index

1158P1
color 1

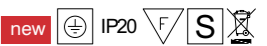

25W, 2755lm, 3000K / 4000K

1158P1L2
color 1

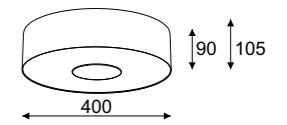

Carina 50 plafon / ceiling lamp



3x max 60W, 230V, 50Hz

Index

1158P2
color 1

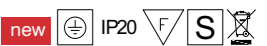

25W, 2755lm, 3000K / 4000K

1158P2L2
color 1

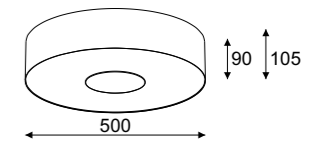

Carina 60 plafon / ceiling lamp



4x max 60W, 230V, 50Hz

Index

1158P3
color 1

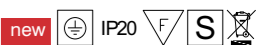

75W, 8265lm, 3000K / 4000K

1158P3D3
color 1

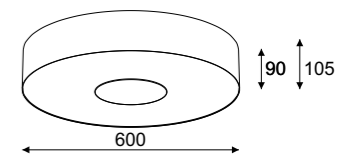

Carina 70 plafon / ceiling lamp



4x max 60W, 230V, 50Hz

Index

1158P4
color 1

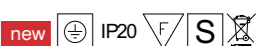

75W, 8265lm, 3000K / 4000K

1158P4D3
color 1

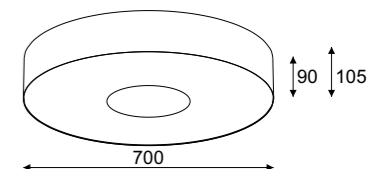



Carina 40 wisząca / hanging lamp



E27

3x max 60W, 230V, 50Hz

Index

1158W1
color 1



LED ECO

25W, 2755lm, 3000K / 4000K

1158W1L2
color 1

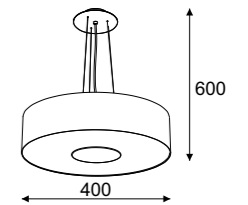

Carina 50 wisząca / hanging lamp



E27

3x max 60W, 230V, 50Hz

Index

1158W2
color 1



LED ECO

25W, 2755lm, 3000K / 4000K

1158W2L2
color 1

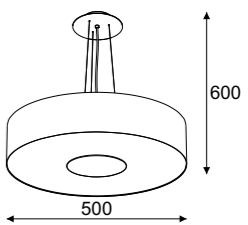

Carina 60 wisząca / hanging lamp



E27

3x max 60W, 230V, 50Hz

Index

1158W3
color 1



LED ECO

75W, 8265lm, 3000K / 4000K

1158W3D3
color 1

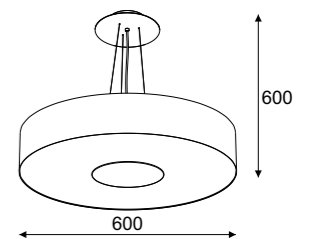

Carina 70 wisząca / hanging lamp



E27

3x max 60W, 230V, 50Hz

Index

1158W4
color 1



LED ECO

75W, 8265lm, 3000K / 4000K

1158W4D3
color 1

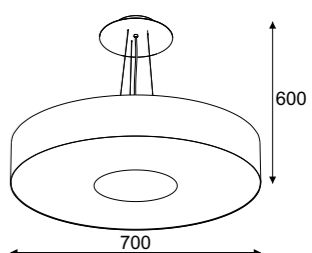

Carina



Carina 40 kinkiet / wall lamp

Index

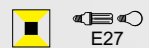
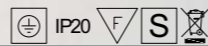

1x max 60W, 230V, 50Hz

1158K1
color 1

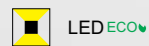

9W, 873lm, 3000K / 4000K

1158K1L5
color 1

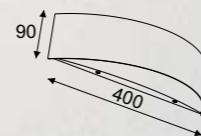

Carina 50 kinkiet / wall lamp

Index



1x max 60W, 230V, 50Hz

1158K2
color 1

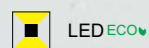

9W, 873lm, 3000K / 4000K

1158K2L5
color 1

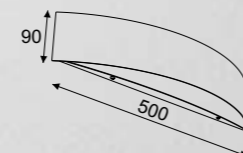

Carina 40 wisząca / hanging lamp

Index

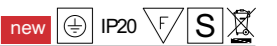

3x max 60W, 230V, 50Hz

1158R1
color 1



25W, 2755lm, 3000K / 4000K

1158R2L2
color 1

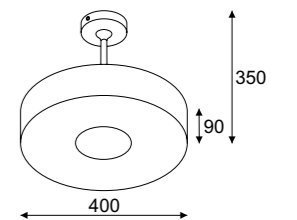

Nuoro



Nuoro wisząca / hanging lamp

Index



E27

3x max 60W, 230V, 50Hz

1343W4AE3
color 1



LED ECO

25W, 2755lm, 3000K / 4000K

1343W4AL2
color 1

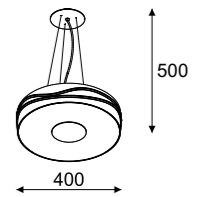

Nuoro wisząca / hanging lamp

Index



E27

3x max 60W, 230V, 50Hz

1343W5AE3
color 1



LED ECO

25W, 2755lm, 3000K / 4000K

1343W5AL2
color 1

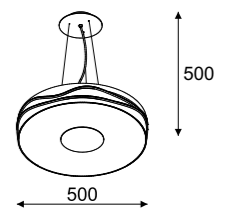

Nuoro wisząca / hanging lamp

Index



E27

4x max 60W, 230V, 50Hz

1343W6AE4
color 1



LED ECO

75W, 8265lm, 3000K / 4000K

1343W6AD3
color 1

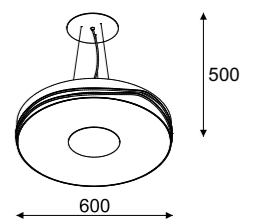

Nuoro wisząca / hanging lamp

Index



E27

4x max 60W, 230V, 50Hz

1343W7AE4
color 1



LED ECO

75W, 8265lm, 3000K / 4000K

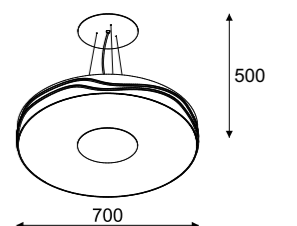

1343W7AD5
color 1



Nuoro

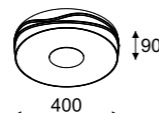

Nuoro plafon / ceiling lamp

| | | Index | ⊕ IP20 F S |
|---|----------------------------|----------------------|---|
|  E27 | 3x max 60W, 230V, 50Hz | 1343P4AE3 color 1 |  |
|  LED ECO | 25W, 2755lm, 3000K / 4000K | 1343P4AL2 color 1 | |



Nuoro plafon / ceiling lamp

| | | Index | ⊕ IP20 F S |
|---|----------------------------|----------------------|---|
|  E27 | 3x max 60W, 230V, 50Hz | 1343P5AE3 color 1 |  |
|  LED ECO | 25W, 2755lm, 3000K / 4000K | 1343P5AL2 color 1 | |

Nuoro plafon / ceiling lamp

| | | Index | ⊕ IP20 F S |
|---|----------------------------|----------------------|---|
|  E27 | 4x max 60W, 230V, 50Hz | 1343P6AE4 color 1 |  |
|  LED ECO | 75W, 8265lm, 3000K / 4000K | 1343P6AD3 color 1 | |



Nuoro plafon / ceiling lamp

| | | Index | ⊕ IP20 F S |
|---|----------------------------|----------------------|---|
|  E27 | 4x max 60W, 230V, 50Hz | 1343P6AE4 color 1 |  |
|  LED ECO | 75W, 8265lm, 3000K / 4000K | 1343P7AD3 color 1 | |

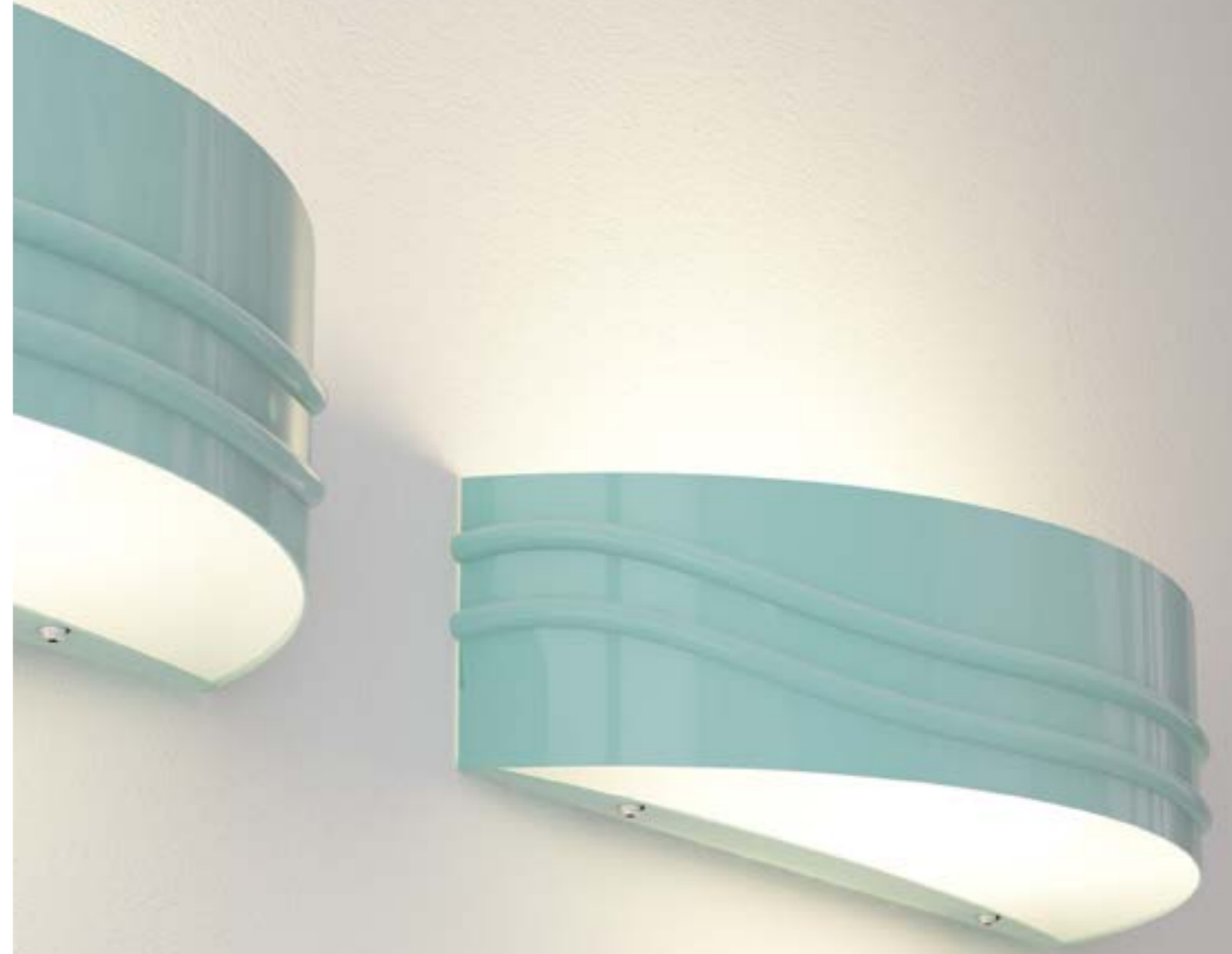

Nuoro

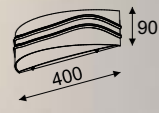

Nuoro kinkiet / wall lamp

| | | Index | ⊕ IP20 F S |
|---|--------------------------|----------------------|---|
|  E27 | 1x max 60W, 230V, 50Hz | 1343K4AE1 color 1 |  |
|  LED ECO | 9W, 873lm, 3000K / 4000K | 1343K4AL5 color 1 | |

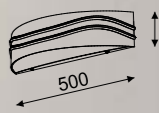
Nuoro kinkiet / wall lamp

| | | Index | ⊕ IP20 F S |
|---|--------------------------|----------------------|---|
|  E27 | 1x max 60W, 230V, 50Hz | 1343K5AE1 color 1 |  |
|  LED ECO | 9W, 873lm, 3000K / 4000K | 1343K5AL5 color 1 | |

Celia, Certo

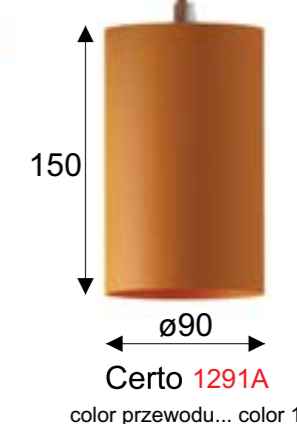
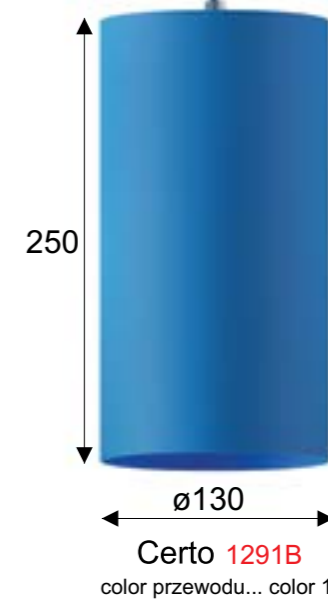
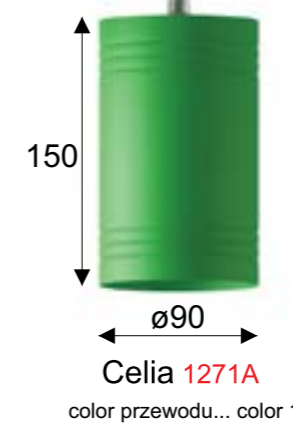
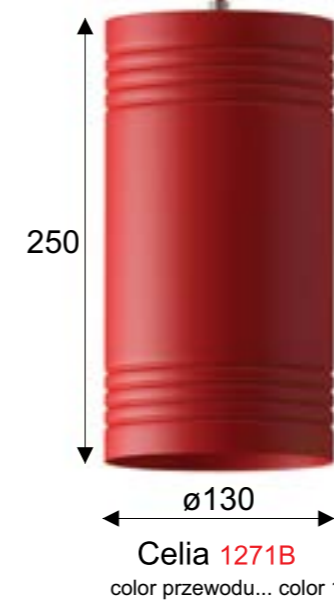

Konfiguracja:



1x max 23W, 230V, 50Hz



Standardowa długość przewodu wynosi 1,5m.
Na życzenie klienta indywidualna konfiguracja.

The standard wire length is 1,5m.
On special order we can make individual configuration.

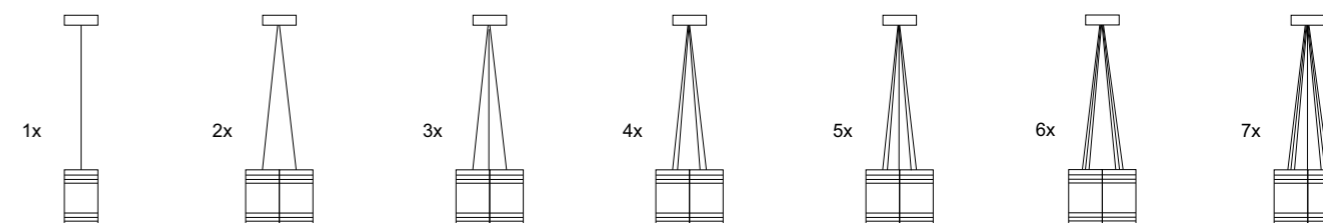

Uran



Uran wisząca / hanging lamp



1x max 60W, 230V, 50Hz

Index

1296Z1
color przewodu...color 1

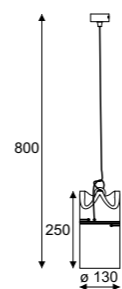

Uran kinkiet / wall lamp



1x max 60W, 230V, 50Hz

Index

1296K1
color przewodu...color 1

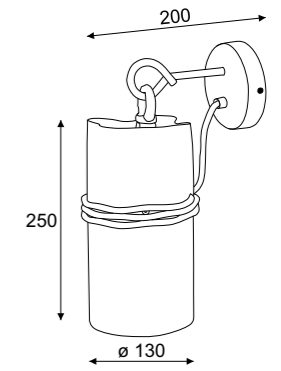
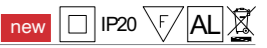

Uran stojąca / floor - standing



1x max 60W, 230V, 50Hz

Index

1296S1
color przewodu...color 1

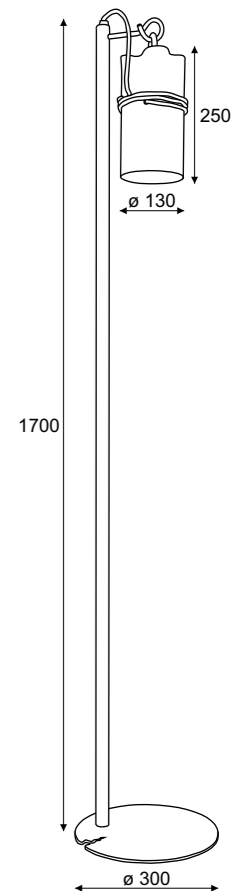
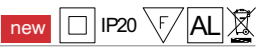

Minimal



Minimal 1247A1 plafon / ceiling lamp



1x 60W, 230V, 50Hz

Index

1247A1
color 1, 601

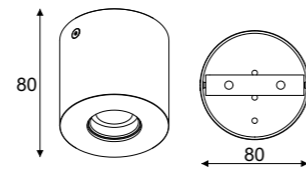

Minimal 1247A2 plafon / ceiling lamp



1x max 60W, 230V, 50Hz

Index

1247A2
color 1, 601

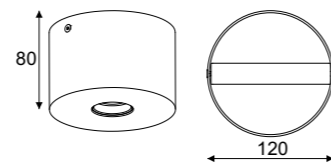

Minimal wpust oczko stropowe/ ceiling - spots



1x max 60W, 230V, 50Hz

Index

1247E3
color 1, 601

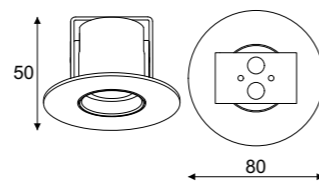

Arta

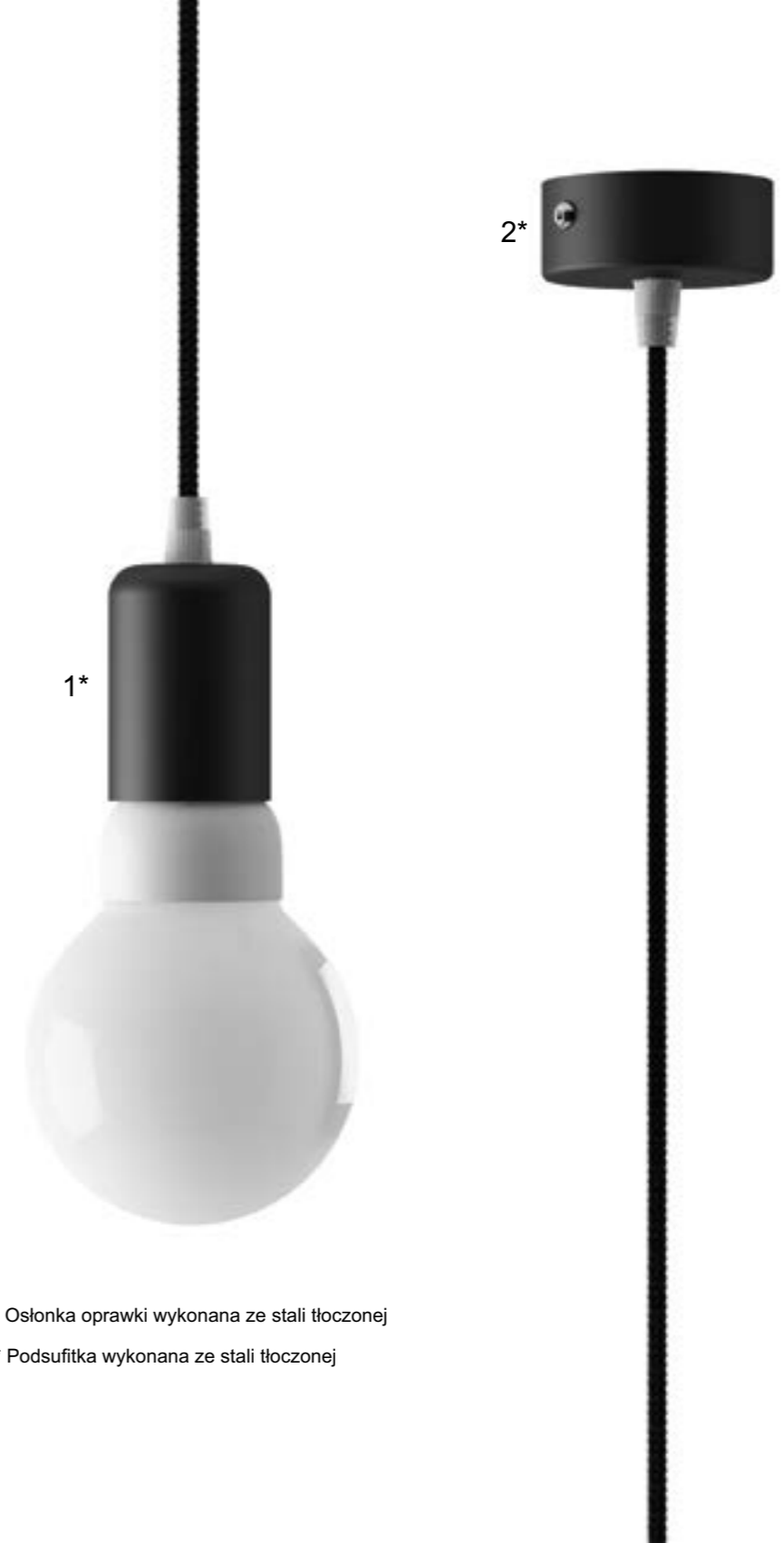

1* Osłonka oprawki wykonana ze stali tłoczonej

2* Podsufitka wykonana ze stali tłoczonej

Arta wisząca / hanging lamp



1x max 60W, 230V, 50Hz

Index

1276
color przewodu... color1

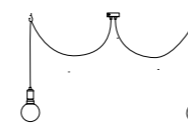
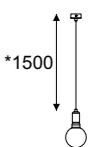
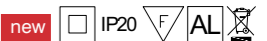

Przewód: 2 x 1,5m

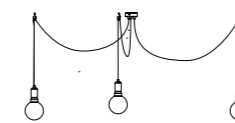

Przewód: 3 x 1,5m

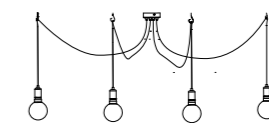

Przewód: 4 x 1,5m

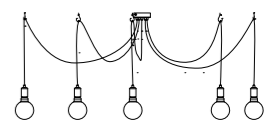

Przewód: 5 x 1,5m

*Dłuższy przewód na życzenie klienta za dopłatą.

Lugo



1* Osłonka oprawki wykonana z aluminium
2* Podsufitka wykonana z aluminium

Ego



1* Oprawka ceramiczna
2* Podsufitka wykonana ze stali tłoczonej

Lugo wisząca / hanging lamp

Index

new IP20 F AL

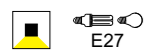

1x max 60W, 230V, 50Hz

1274
color przewodu... color1

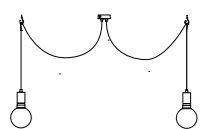
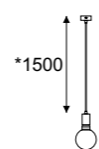

Przewód: 2 x 1,5m

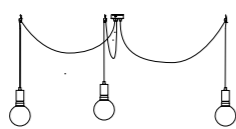

Przewód: 3 x 1,5m

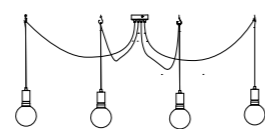

Przewód: 4 x 1,5m

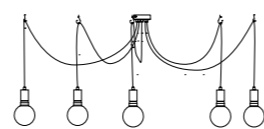

Przewód: 5 x 1,5m

*Dłuższy przewód na życzenie klienta za dopłatą.

Ego wisząca / hanging lamp

Index

new IP20 F AL



1x max 60W, 230V, 50Hz

1298
color przewodu... color1

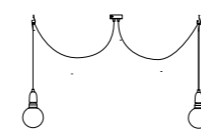
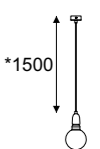

Przewód: 2 x 1,5m

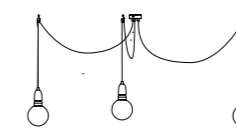

Przewód: 3 x 1,5m

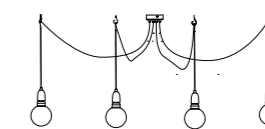

Przewód: 4 x 1,5m

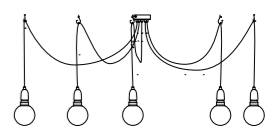

Przewód: 5 x 1,5m

*Dłuższy przewód na życzenie klienta za dopłatą.

Nea



- 1* Oprawka ceramiczna
- 2* Podsufitka wykonana ze stali tłoczonej
- 3* Linka stalowa z automatem

Nea wisząca / hanging lamp

Index

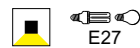

1x max 60W, 230V, 50Hz

1275
color przewodu... color1

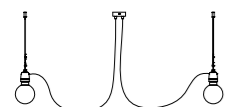
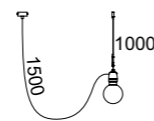

przewód: 2 x 1,5m
linka stalowa: 2 x 1m

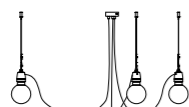

przewód: 3 x 1,5m
linka stalowa: 3 x 1m



przewód: 4 x 1,5m
linka stalowa: 4 x 1m

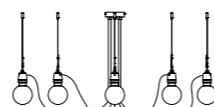

przewód: 5 x 1,5m
linka stalowa: 5 x 1m

*Dłuższy przewód oraz linka stalowa na życzenie klienta za dopłatą.

Octopus



Octopus wisząca / hanging lamp

Index

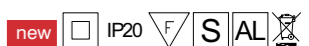

10x max 60W, 230V, 50Hz

1201A10
color przewodu... color1

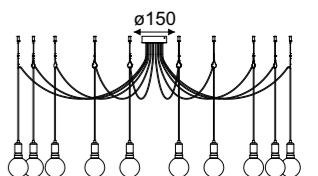

Standardowa długość przewodu oraz linki stalowej 10 x 1500 mm.
Dłuższe przewody oraz linki stalowe na życzenie klienta za dopłatą.

Perak



Perak wisząca / hanging lamp

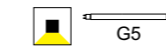

G5

3x 14W, 230V, 50Hz

Index

1302T2C
color 1

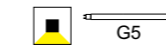
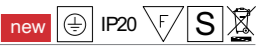

G5

3x 24W, 230V, 50Hz

1302T2D
color 1

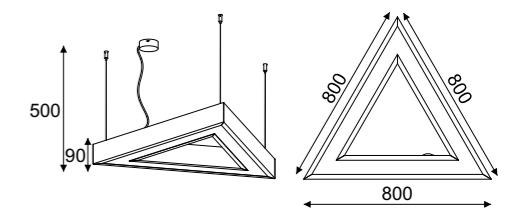

LED ECO

54W, 5238lm, 3000K / 4000K

1302T2L4
color 2

Perak wisząca / hanging lamp

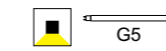

G5

2x 21W + 1x 14W, 230V, 50Hz

Index

1302T3E
color 1

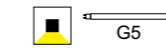
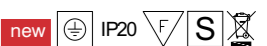

G5

2x 39W + 1x 24, 230V, 50Hz

1302T3H
color 1

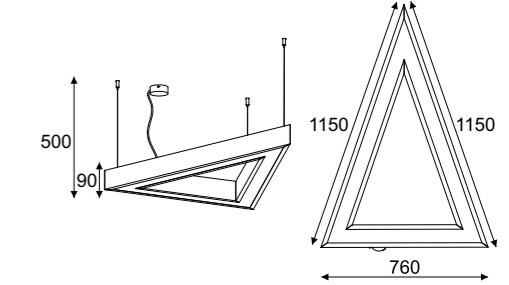

LED ECO

72W, 6984lm, 3000K / 4000K

1302T3D8
color 2

Perak wisząca / hanging lamp

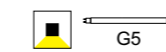

G5

3x 21W, 230V, 50Hz

Index

1302T1A
color 1

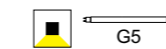
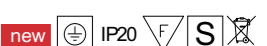

G5

3x 39W, 230V, 50Hz

1302T1B
color 1

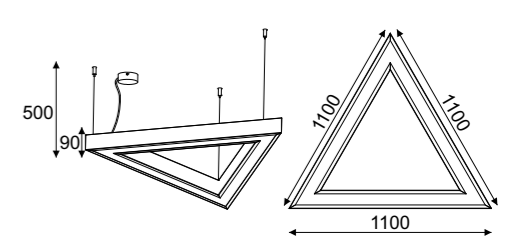

LED ECO

81W, 7857lm, 3000K / 4000K

1302T1D2
color 2

Perak



Perak wisząca / hanging lamp

Index

new IP20 F S

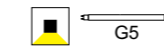

G5

4x 21W, 230V, 50Hz

1302K1A
color 1

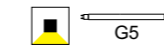

G5

4x 39W, 230V, 50Hz

1302K1B
color 1



LED ECO

108W, 10476lm, 3000K / 4000K

31302K1D9
color 1

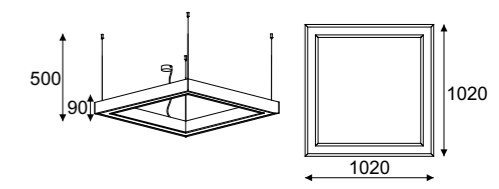

Perak wisząca / hanging lamp

Index

new IP20 F S

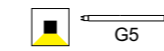

G5

4x 14W, 230V, 50Hz

1302K2C
color 1

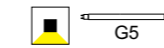

G5

4x 24W, 230V, 50Hz

1302K2D
color 1



LED ECO

72W, 6984lm, 3000K / 4000K

31302K2L8
color 1

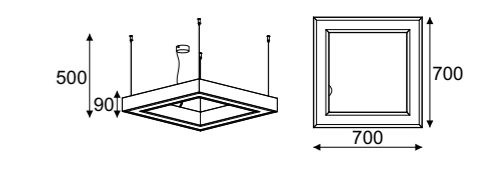

Perak wisząca / hanging lamp

Index

new IP20 F S

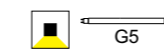

G5

2x 21W + 2x 14W, 230V, 50Hz

1302K3E
color 1

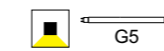

G5

2x 39W + 2x 24W, 230V, 50Hz

1302K3H
color 1



LED ECO

90W, 8730lm, 3000K / 4000K

1302K3K1
color 1

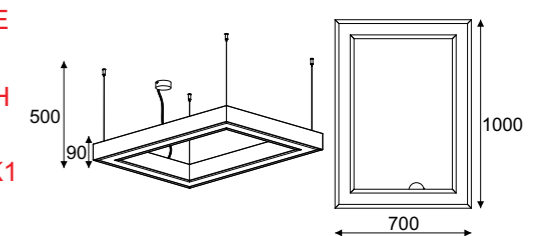

Belona



Belona 1303E plafon / ceiling lamp

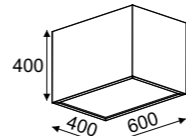
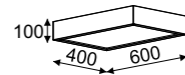

 3x max 60W, 230V, 50Hz **Index** **1303E1E3**
color 1

1303E2E3
color 1

1303E4E3
color 1

 36W, 3492lm, 3000K **Index** **1303E1D1**
color 1

1303E2D1
color 1

1303E4D1
color 1

Belona 1303H plafon / ceiling lamp

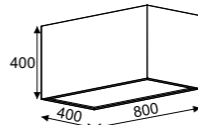
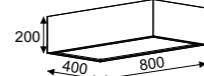

 4x max 60W, 230V, 50Hz **Index** **1303H1E3**
color 1

1303H2E3
color 1

1303H4E3
color 1

 36W, 3492lm, 3000K **Index** **1303H1D1**
color 1

1303H2D1
color 1

1303H4D1
color 1

Belona 1303R plafon / ceiling lamp

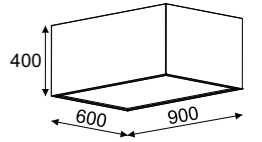
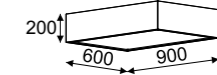
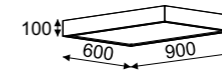

 4x max 60W, 230V, 50Hz **Index** **1303R1E4**
color 1

1303R2E4
color 1

1303R4E4
color 1

 54W, 5238lm, 3000K **Index** **1303R1L4**
color 1

1303R2L4
color 1

1303R4L4
color 1

Belona 1303A plafon / ceiling lamp

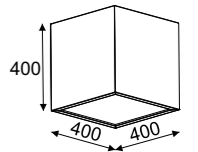
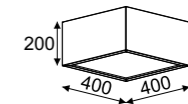
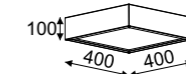

 3x max 60W, 230V, 50Hz **Index** **1303A1E3**
color 1

1303A2E3
color 1

1303A4E3
color 1

 25W, 2755lm, 3000K **Index** **1303A1L2**
color 1

1303A2L2
color 1

1303A4L2
color 1

Belona 1303B plafon / ceiling lamp

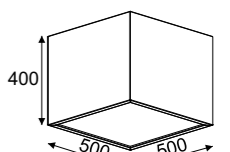
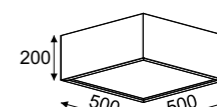
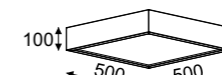

 4x max 60W, 230V, 50Hz **Index** **1303B1E3**
color 1

1303B2E3
color 1

1303B4E3
color 1

 25W, 2755lm, 3000K **Index** **1303B1L2**
color 1

1303B2L2
color 1

1303B4L2
color 1

Belona 1303C plafon / ceiling lamp

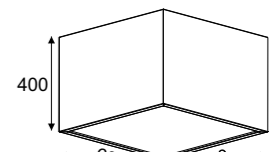
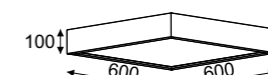

 4x max 60W, 230V, 50Hz **Index** **1303C1E4**
color 1

1303C2E4
color 1

1303C4E4
color 1

 32W, 3444lm, 3000K **Index** **1303C1L3**
color 1



1303C2L3
color 1

1303C4L3
color 1

Rita



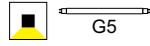
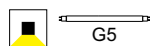

Rita 1268 plafon / ceiling lamp

| | | |
|--|----------------------------|----------------------------|
|  | 1x 14W, 230V, 50Hz | 1268PB1 color 1 |
|  | 1x 24W, 230V, 50Hz | 1268PB2 color 1 |
|  | 36W, 3492lm, 3000K / 4000K | 1268PBD1 color 1 |

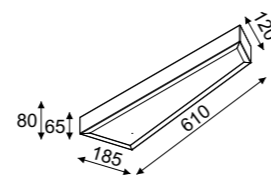
Index



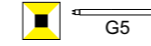

Rita 1268 wisząca / hanging lamp

| | | |
|---|----------------------------|----------------------------|
|  | 1x 14W, 230V, 50Hz | 1268WB1 color 1 |
|  | 1x 24W, 230V, 50Hz | 1268WB2 color 1 |
|  | 36W, 3492lm, 3000K / 4000K | 1268WBD1 color 1 |

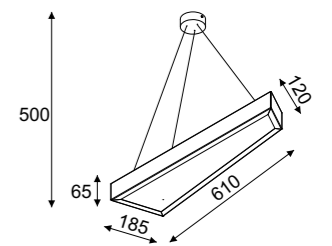
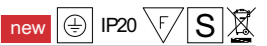
Index



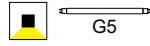
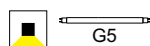

Rita 1268 plafon / ceiling lamp

| | | |
|--|----------------------------|----------------------------|
|  | 2x 21W, 230V, 50Hz | 1268PA1 color 1 |
|  | 2x 39W, 230V, 50Hz | 1268PA2 color 1 |
|  | 81W, 7857lm, 3000K / 4000K | 1268PAD2 color 1 |

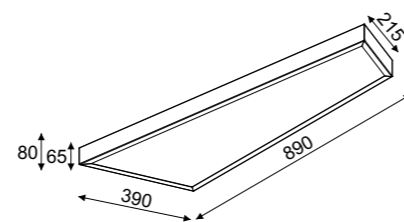
Index



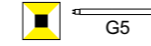

Rita 1268 wisząca / hanging lamp

| | | |
|---|----------------------------|----------------------------|
|  | 2x 21W, 230V, 50Hz | 1268WA1 color 1 |
|  | 2x 39W, 230V, 50Hz | 1268WA2 color 1 |
|  | 81W, 7857lm, 3000K / 4000K | 1268WAD2 color 1 |

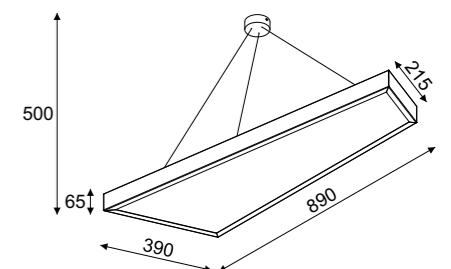
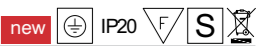
Index



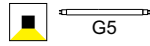
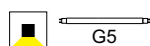

Rita 1268 plafon / ceiling lamp

| | | |
|--|------------------------------|----------------------------|
|  | 3x 14W, 230V, 50Hz | 1268PC1 color 1 |
|  | 3x 24W, 230V, 50Hz | 1268PC2 color 1 |
|  | 108W, 10476lm, 3000K / 4000K | 1268PCD4 color 1 |

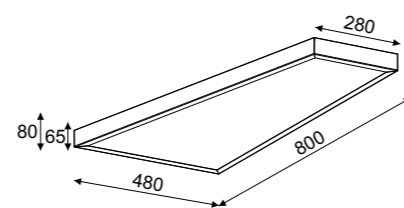
Index

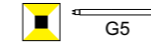

Rita 1268 wisząca / hanging lamp

| | | |
|---|------------------------------|----------------------------|
|  | 3x 14W, 230V, 50Hz | 1268WC1 color 1 |
|  | 3x 24W, 230V, 50Hz | 1268WC2 color 1 |
|  | 108W, 10476lm, 3000K / 4000K | 1268WCD4 color 1 |



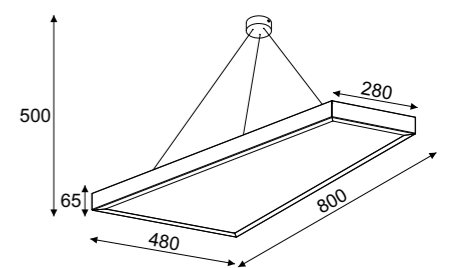
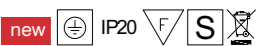











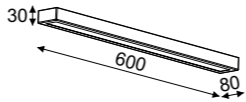



Index

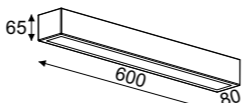

Lino



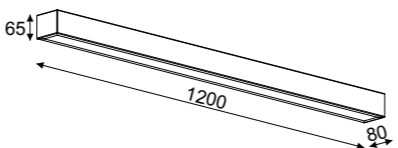













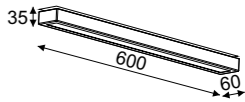

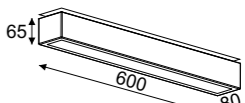

Stal nierdzewna polerowana color 13

| Lino kinkiet / wall lamp | | Index |     | |
|--|----------------------------|--------------------|---|--|
|  | 1x 14W / 24W, 230V, 50Hz | 1265KA1BT1B |  | |
|  | 18W, 1746lm, 3000K / 4000K | 1265KA1BL6B | | |
| Lino kinkiet / wall lamp | | Index |     | |
|  | 1x 14W, 24W, 230V, 50Hz | 1265KA1AT1B |  | |
|  | 18W, 1746lm, 3000K / 4000K | 1265KA1AL6B | | |
| Lino kinkiet / wall lamp | | Index |     | |
|  | 2x 14W, 24W, 230V, 50Hz | 1265KC1AT2B |  | |
|  | 36W, 3492lm, 3000K / 4000K | 1265KC1AD1B | | |

Lino z przesłoną

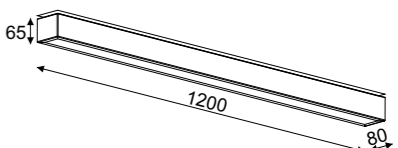

Stal nierdzewna polerowana color 13

| Lino kinkiet / wall lamp | | Index |     | |
|---|----------------------------|--------------------|---|--|
|  | 1x 14W, 24W, 230V, 50Hz | 1265KA1BT1P |  | |
|  | 18W, 1746lm, 3000K / 4000K | 1265KA1BL6P | | |
| Lino kinkiet / wall lamp | | Index |     | |
|  | 1x 14W, 24W, 230V, 50Hz | 1265KA1AT1P |  | |
|  | 18W, 1746lm, 3000K / 4000K | 1265KA1AL6P | | |
| Lino kinkiet / wall lamp | | Index |     | |
|  | 2x 14W, 24W, 230V, 50Hz | 1265KC1AT2P |  | |
|  | 36W, 3492lm, 3000K / 4000K | 1265KC1AD1P | | |

Vandura



Vandura 280 wisząca / hanging lamp

Index



E27

2x max 60W, 230V, 50Hz

1139W1
color 1



LED ECO

19W, 2066lm, 3000K / 4000K

1139W1L1
color 1

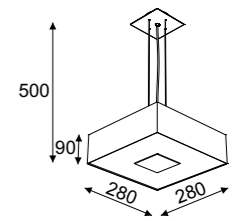

Vandura 350 wisząca / hanging lamp

Index



E27

4x max 60W, 230V, 50Hz

1139W2
color 1



LED ECO

19W, 2066lm, 3000K / 4000K

1139W2L1
color 1

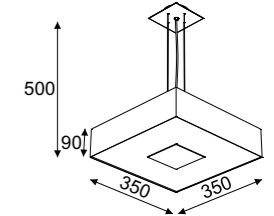

Vandura 400 wisząca / hanging lamp

Index



E27

4x max 23W, 230V, 50Hz

1139W3
color 1



LED ECO

25W, 2755lm, 3000K / 4000K

1139W3L2
color 1

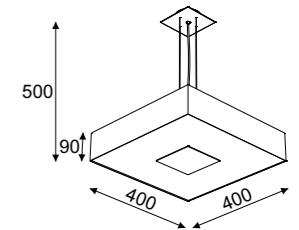

Vandura 500 wisząca / hanging lamp

Index



E27

4x max 60W, 230V, 50Hz

1139W4
color 1



LED ECO

25W, 2755lm, 3000K / 4000K

1139W4L2
color 1



LED ECO

32W, 3444lm, 3000K / 4000K

1139W4L3
color 1

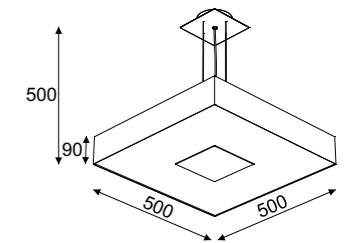

Vandura 600 wisząca / hanging lamp

Index



E27

4x max 60W, 230V, 50Hz

1139W5
color 1



LED ECO

32W, 3444lm, 3000K / 4000K

1139W5L3
color 1



LED ECO

54W, 5238lm, 3000K / 4000K

1139W5L4
color 1

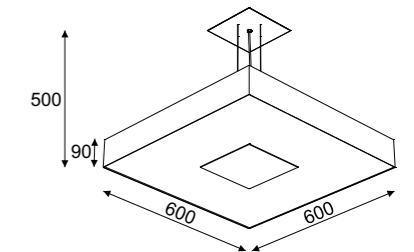

Vandura 700 wisząca / hanging lamp

Index



E27

4x max 60W, 230V, 50Hz

1139W6
color 1



LED ECO

32W, 3444lm, 3000K / 4000K

1139W6L3
color 1



LED ECO

54W, 5238lm, 3000K / 4000K

1139W6L4
color 1

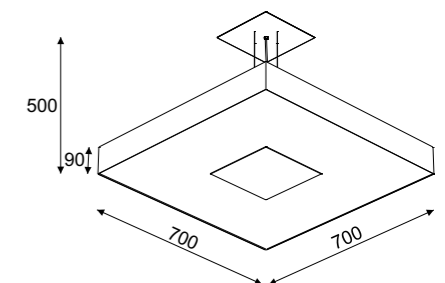

Vandura



Vandura 280 plafon / ceiling lamp

Index

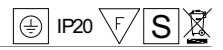

E27

2x max 60W, 230V, 50Hz

1139P1
color 1



LED ECO

19W, 2066lm, 3000K / 4000K

1139P1L1
color 1

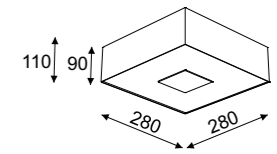

Vandura 350 plafon / ceiling lamp

Index

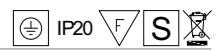

E27

4x max 60W, 230V, 50Hz

1139P2
color 1



LED ECO

19W, 2066lm, 3000K / 4000K

1139P2L1
color 1

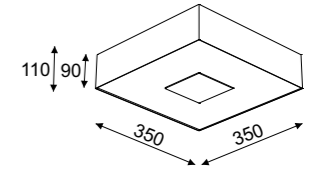

Vandura 400 plafon / ceiling lamp

Index



E27

4x max 60W, 230V, 50Hz

1139P3
color 1



LED ECO

25W, 2755lm, 3000K / 4000K

1139P3L2
color 1

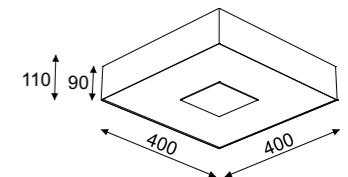

Vandura 500 plafon / ceiling lamp

Index



E27

4 x max 60W, 230V, 50Hz

1139P4
color 1



LED ECO

25W, 2755lm, 3000K / 4000K

1139P4L2
color 1



LED ECO

32W, 3444lm, 3000K / 4000K

1139P4L3
color 1

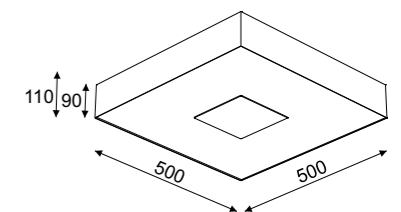

Vandura 600 plafon / ceiling lamp

Index



E27

4x max 60W, 230V, 50Hz

1139P5
color 1



LED ECO

32W, 3444lm, 3000K / 4000K

1139P5L3
color 1



LED ECO

54W, 5238lm, 3000K / 4000K

1139P5L4
color 1

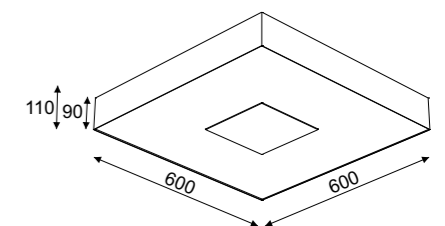

Vandura 700 plafon / ceiling lamp

Index



E27

4x max 60W, 230V, 50Hz

1139P6
color 1



LED ECO

32W, 3444lm, 3000K / 4000K

1139P6L3
color 1



LED ECO

54W, 5238lm, 3000K / 4000K

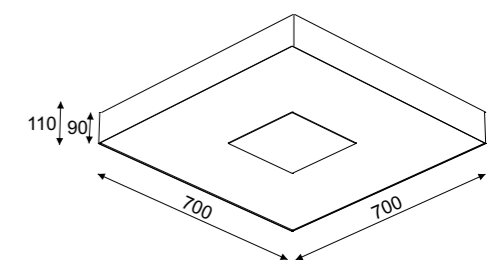

1139P6L4
color 1



Rooster



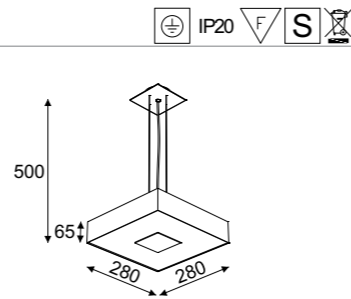

Rooster 280 wiszący / hanging lamp

| | | |
|--|----------------------------|----------------------------|
|  | 1 x 22W, 230V, 50Hz | 1145W1 color 1 |
|  | 19W, 2066lm, 3000K / 4000K | 1145W1L1 color 1 |



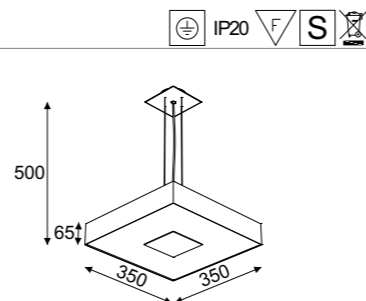

Rooster 350 wiszący / hanging lamp

| | | |
|--|----------------------------|----------------------------|
|  | 1 x 22W, 230V, 50Hz | 1145W2 color 1 |
|  | 19W, 2066lm, 3000K / 4000K | 1145W2L1 color 1 |





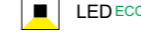

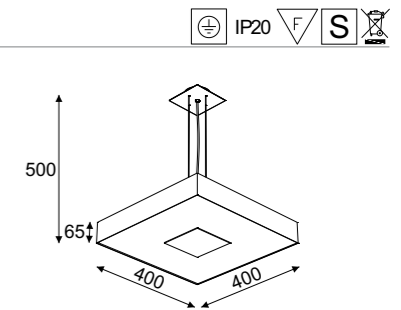
Rooster 400 wiszący / hanging lamp

| | | |
|---|----------------------------|----------------------------|
|  | 1 x 40W, 230V, 50Hz | 1145W3 color 1 |
|  | 1 x 55W, 230V, 50Hz | 1145W4 color 1 |
|  | 25W, 2755lm, 3000K / 4000K | 1145W3L2 color 1 |



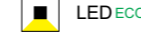

Rooster 500 wiszący / hanging lamp

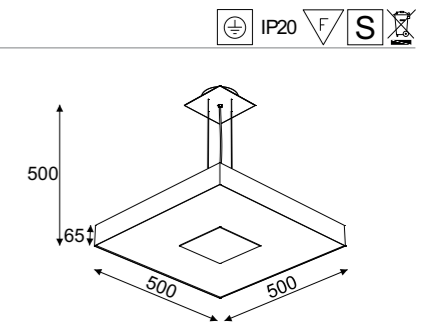
| | | |
|---|----------------------------|----------------------------|
|  | 1 x 40W, 230V, 50Hz | 1145W5 color 1 |
|  | 1 x 55W, 230V, 50Hz | 1145W6 color 1 |
|  | 25W, 2755lm, 3000K / 4000K | 1145W5L2 color 1 |
|  | 32W, 3444lm, 3000K / 4000K | 1145W5L3 color 1 |





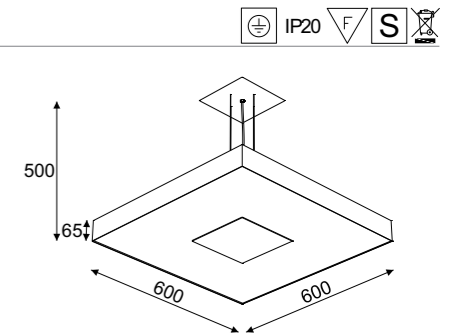

Rooster 600 wiszący / hanging lamp

| | | |
|---|----------------------------|----------------------------|
|  | 4 x 22W, 230V, 50Hz | 1145W7 color 1 |
|  | 32W, 3444lm, 3000K / 4000K | 1145W7L3 color 1 |
|  | 54W, 5238lm, 3000K / 4000K | 1145W7L4 color 1 |

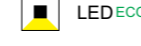

Rooster 700 wiszący / hanging lamp

| | | |
|---|----------------------------|----------------------------|
|  | 4 x 40W, 230V, 50Hz | 1145W8 color 1 |
|  | 4 x 55W, 230V, 50Hz | 1145W9 color 1 |
|  | 32W, 3444lm, 3000K / 4000K | 1145W8L3 color 1 |
|  | 54W, 5238lm, 3000K / 4000K | 1145W8L4 color 1 |

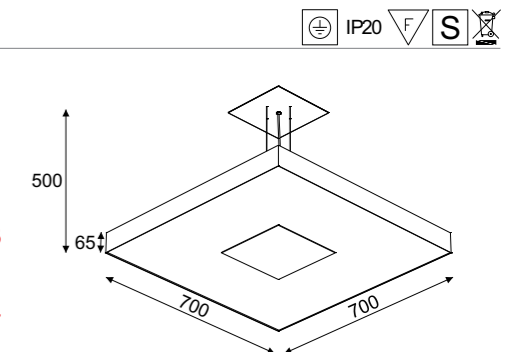

Rooster

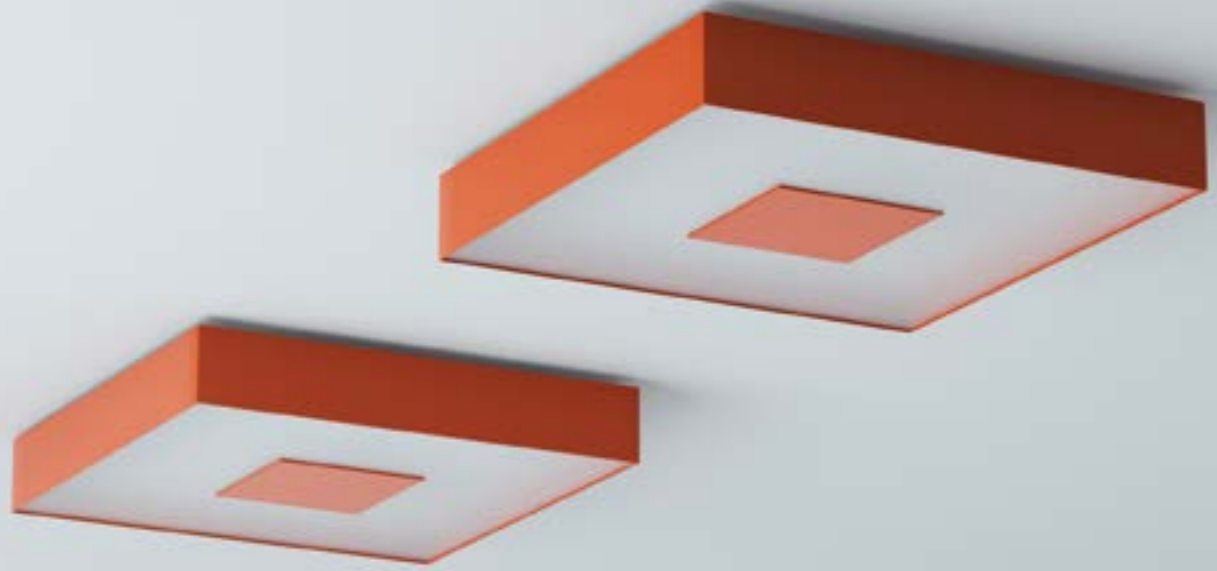

Rooster 280 plafon / ceiling lamp

| | | |
|--|----------------------------|----------------------------|
| | 1x 22W, 230V, 50Hz | 1145P1 color 1 |
| | 19W, 2066lm, 3000K / 4000K | 1145P1L1 color 1 |

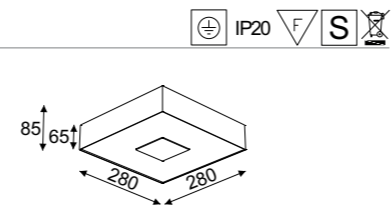

IP20 F S

Rooster 350 plafon / ceiling lamp

| | | |
|--|----------------------------|----------------------------|
| | 1x 22W, 230V, 50Hz | 1145P2 color 1 |
| | 19W, 2066lm, 3000K / 4000K | 1145P2L1 color 1 |

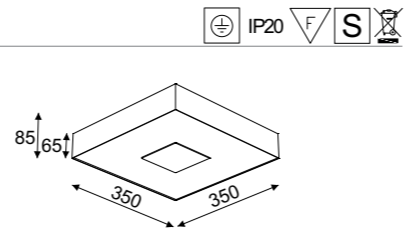

IP20 F S

Rooster 400 plafon / ceiling lamp

| | | |
|--|----------------------------|----------------------------|
| | 1x 40W, 230V, 50Hz | 1145P3 color 1 |
| | 1x 55W, 230V, 50Hz | 1145P4 color 1 |
| | 25W, 2755lm, 3000K / 4000K | 1145P3L2 color 1 |

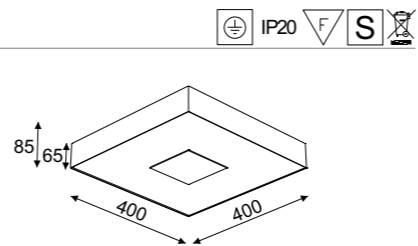

IP20 F S

Rooster 500 plafon / ceiling lamp

| | | |
|--|----------------------------|----------------------------|
| | 1x 40W, 230V, 50Hz | 1145P5 color 1 |
| | 1x 55W, 230V, 50Hz | 1145P6 color 1 |
| | 25W, 2755lm, 3000K / 4000K | 1145P5L2 color 1 |
| | 32W, 3444lm, 3000K / 4000K | 1145P5L3 color 1 |

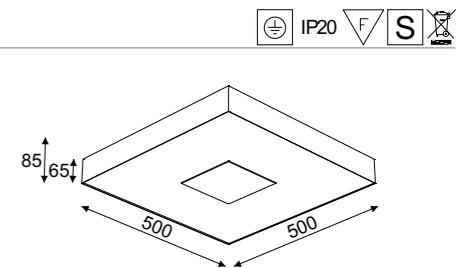

IP20 F S

Vandura 600 plafon / ceiling lamp

| | | |
|--|----------------------------|----------------------------|
| | 4x 22W, 230V, 50Hz | 1145P7 color 1 |
| | 32W, 3444lm, 3000K / 4000K | 1145P7L3 color 1 |
| | 54W, 5238lm, 3000K / 4000K | 1145P7L4 color 1 |

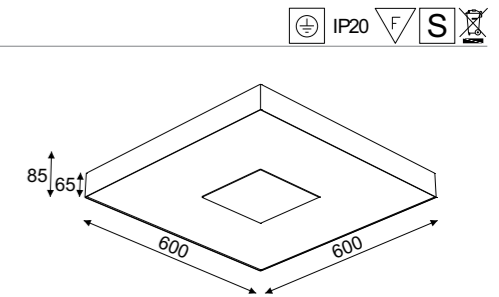

IP20 F S

Vandura 700 plafon / ceiling lamp

| | | |
|--|----------------------------|----------------------------|
| | 4x 40W, 230V, 50Hz | 1145P8 color 1 |
| | 4x 55W, 230V, 50Hz | 1145P9 color 1 |
| | 32W, 3444lm, 3000K / 4000K | 1145P8L3 color 1 |
| | 54W, 5238lm, 3000K / 4000K | 1145P8L4 color 1 |

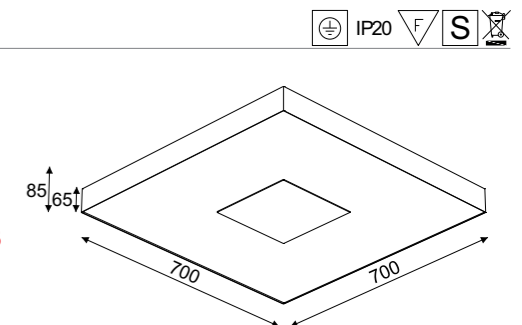

IP20 F S

Nekla



Nekla 40 wisząca / hanging lamp



4x max 60W, 230V, 50Hz

Index



25W, 2755lm, 3000K / 4000K

1152W1
color 1

1152W1L2
color 1

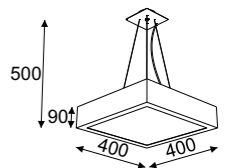

Nekla 50 wisząca / hanging lamp

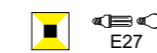

4x max 60W, 230V, 50Hz

Index



25W, 2755lm, 3000K / 4000K

1152W2
color 1

1152W2L2
color 1



32W, 3444lm, 3000K / 4000K

1152W2L3
color 1

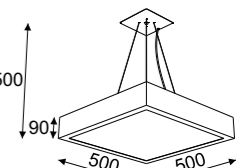

Nekla 60 wisząca / hanging lamp



4x max 60W, 230V, 50Hz

Index



32W, 3444lm, 3000K / 4000K

1152W3
color 1

1152W3L3
color 1



54W, 5238lm, 3000K / 4000K

1152W3L4
color 1

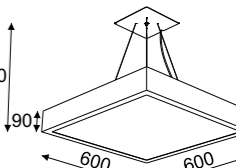

Nekla 70 wisząca / hanging lamp



4x max 60W, 230V, 50Hz

Index



32W, 3444lm, 3000K / 4000K

1152W4
color 1

1152W4L3
color 1



54W, 5238lm, 3000K / 4000K

1152W4L4
color 1

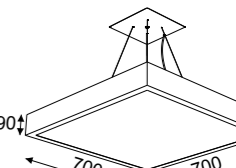

Nekla



Nekla 40 plafon / ceiling lamp

| | | |
|--|----------------------------|----------------------------|
| | 3x max 60W, 230V, 50Hz | 1152P1 color 1 |
| | 25W, 2755lm, 3000K / 4000K | 1152P1L2 color 1 |

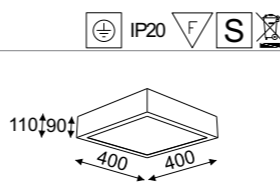

IP20 F S

Nekla 50 plafon / ceiling lamp

| | | |
|--|----------------------------|----------------------------|
| | 3x max 60W, 230V, 50Hz | 1152P2 color 1 |
| | 25W, 2755lm, 3000K / 4000K | 1152P2L2 color 1 |
| | 32W, 3444lm, 3000K / 4000K | 1152P2L3 color 1 |

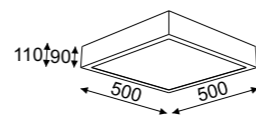

IP20 F S

Nekla 60 plafon / ceiling lamp

| | | |
|--|----------------------------|----------------------------|
| | 4x max 60W, 230V, 50Hz | 1152P3 color 1 |
| | 32W, 3444lm, 3000K / 4000K | 1152P3L3 color 1 |
| | 54W, 5238lm, 3000K / 4000K | 1152P3L4 color 1 |

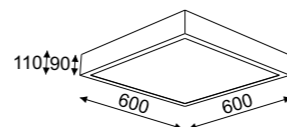

IP20 F S

Nekla 70 plafon / ceiling lamp

| | | |
|--|----------------------------|----------------------------|
| | 4x max 60W, 230V, 50Hz | 1152P4 color 1 |
| | 32W, 3444lm, 3000K / 4000K | 1152P4L3 color 1 |
| | 54W, 5238lm, 3000K / 4000K | 1152P4L4 color 1 |

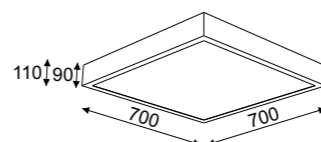

IP20 F S



Nekla 40 kinkiet / wall lamp

| | | |
|--|--------------------------|----------------------------|
| | 1x max 60W, 230V, 50Hz | 1152K1 color 1 |
| | 9W, 873lm, 3000K / 4000K | 1152K1L5 color 1 |

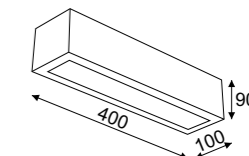

IP20 F S

Nekla 50 kinkiet / wall lamp

| | | |
|--|--------------------------|----------------------------|
| | 2x max 60W, 230V, 50Hz | 1152K2 color 1 |
| | 9W, 873lm, 3000K / 4000K | 1152K2L5 color 1 |

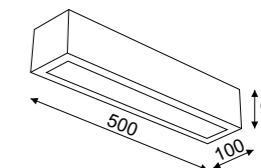

IP20 F S

Nekla 60 kinkiet / wall lamp

| | | |
|--|----------------------------|----------------------------|
| | 2x max 60W, 230V, 50Hz | 1152K3 color 1 |
| | 18W, 1746lm, 3000K / 4000K | 1152K3L6 color 1 |

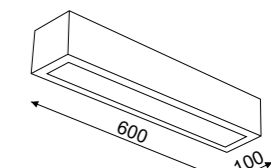

IP20 F S

Nekla 70 kinkiet / wall lamp

| | | |
|--|----------------------------|----------------------------|
| | 2x max 60W, 230V, 50Hz | 1152K4 color 1 |
| | 18W, 1746lm, 3000K / 4000K | 1152K4L6 color 1 |

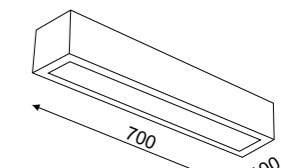

IP20 F S

Nekla 80 kinkiet / wall lamp

| | | |
|--|----------------------------|----------------------------|
| | 2x max 60W, 230V, 50Hz | 1152K5 color 1 |
| | 18W, 1746lm, 3000K / 4000K | 1152K5L6 color 1 |

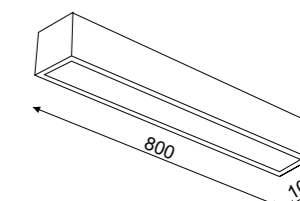



IP20 F S

Noble



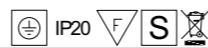
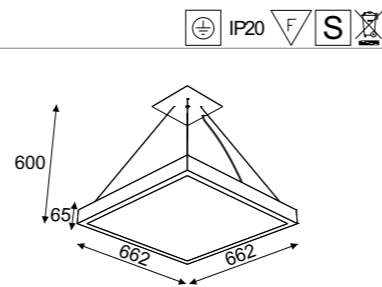

Noble wiszący kwadrat I / hanging square I

| | | Index |
|--|----------------------------|-----------------------------|
|  G5 | 4x 14W, 230V, 50Hz | 1147W61 color 1 |
|  G5 | 4x 24W, 230V, 50Hz | 1147W62 color 1 |
|  LED ECO | 72W, 6984lm, 3000K / 4000K | 1147W61L8 color 1 |



Noble wiszący kwadrat II / hanging square II

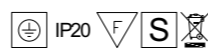
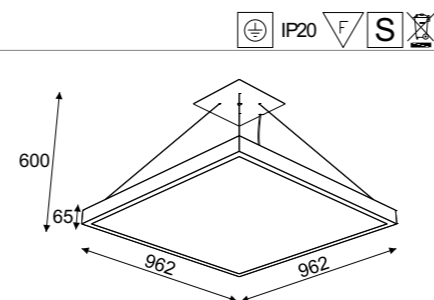

| | | Index |
|--|------------------------------|-----------------------------|
|  G5 | 6x 21W, 230V, 50Hz | 1147W91 color 1 |
|  G5 | 6x 39W, 230V, 50Hz | 1147W92 color 1 |
|  LED ECO | 162W, 15714lm, 3000K / 4000K | 1147W91L9 color 1 |



Noble



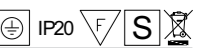
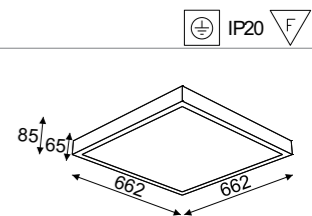

Noble plafon kwadrat I / ceiling square I

| | | Index |
|---|----------------------------|-----------------------------|
|  G5 | 4x 14W, 230V, 50Hz | 1147P61 color 1 |
|  G5 | 4 x 24W, 230V, 50Hz | 1147P62 color 1 |
|  LED ECO | 72W, 6984lm, 3000K / 4000K | 1147P61L8 color 1 |



Noble plafon kwadrat II / ceiling square II

| | | Index |
|---|------------------------------|-----------------------------|
|  G5 | 6x 21W, 230V, 50Hz | 1147P91 color 1 |
|  G5 | 6x 39W, 230V, 50Hz | 1147P92 color 1 |
|  LED ECO | 162W, 15714lm, 3000K / 4000K | 1147P91L9 color 1 |

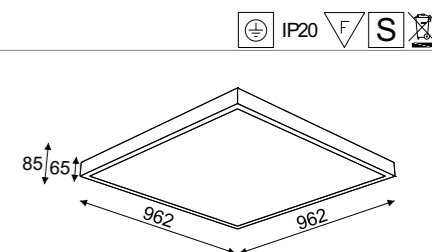

Noble



Noble prostokąt I wiszący / hanging rectangle I

| Symbol | Specyfikacja | Index |
|--------|----------------------------|-----------------------------|
| | 2x 14W, 230V, 50Hz | 1147W65 color 1 |
| | 2x 24W, 230V, 50Hz | 1147W66 color 1 |
| | 36W, 3492lm, 3000K / 4000K | 1147W65D1 color 1 |

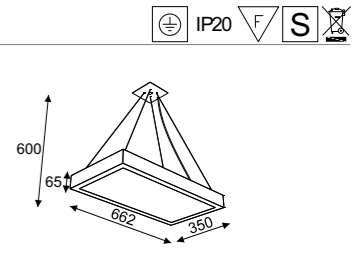

Noble prostokąt II wiszący / hanging rectangle II

| Symbol | Specyfikacja | Index |
|--------|----------------------------|-----------------------------|
| | 3x 14W, 230V, 50Hz | 1147W63 color 1 |
| | 3x 24W, 230V, 50Hz | 1147W64 color 1 |
| | 54W, 5238lm, 3000K / 4000K | 1147W63L4 color 1 |

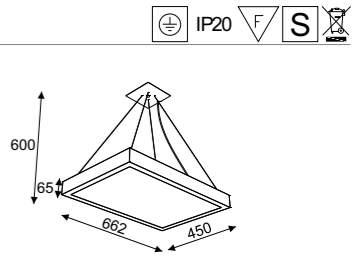

Noble prostokąt III wiszący / hanging rectangle III

| Symbol | Specyfikacja | Index |
|--------|----------------------------|-----------------------------|
| | 2x 21W, 230V, 50Hz | 1147W95 color 1 |
| | 2x 39W, 230V, 50Hz | 1147W96 color 1 |
| | 54W, 5238lm, 3000K / 4000K | 1147W95L4 color 1 |

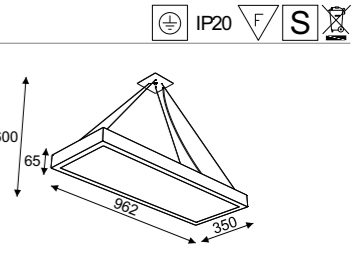

Noble prostokąt IV wiszący / hanging rectangle IV

| Symbol | Specyfikacja | Index |
|--------|----------------------------|-----------------------------|
| | 3x 21W, 230V, 50Hz | 1147W93 color 1 |
| | 3x 39W, 230V, 50Hz | 1147W94 color 1 |
| | 81W, 7857lm, 3000K / 4000K | 1147W93D2 color 1 |

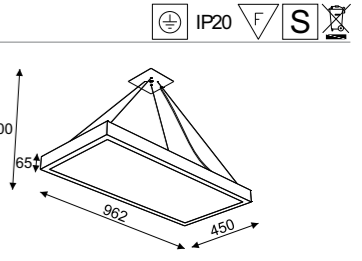

Noble prostokąt I plafon / ceiling rectangle I

| Symbol | Specyfikacja | Index |
|--------|----------------------------|-----------------------------|
| | 2x 14W, 230V, 50Hz | 1147P65 color 1 |
| | 2x 24W, 230V, 50Hz | 1147P66 color 1 |
| | 36W, 3492lm, 3000K / 4000K | 1147P65D1 color 1 |

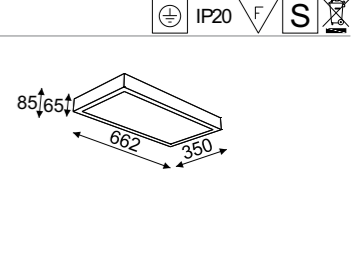

Noble prostokąt II plafon / ceiling rectangle II

| Symbol | Specyfikacja | Index |
|--------|----------------------------|-----------------------------|
| | 3x 14W, 230V, 50Hz | 1147P63 color 1 |
| | 3x 24W, 230V, 50Hz | 1147P64 color 1 |
| | 54W, 5238lm, 3000K / 4000K | 1147P63L4 color 1 |

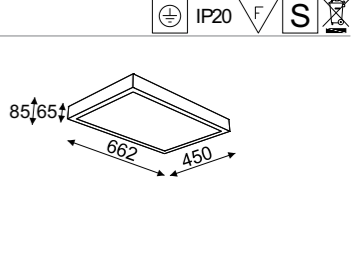

Noble prostokąt III plafon / ceiling rectangle III

| Symbol | Specyfikacja | Index |
|--------|----------------------------|-----------------------------|
| | 2x 21W, 230V, 50Hz | 1147P95 color 1 |
| | 2x 39W, 230V, 50Hz | 1147P96 color 1 |
| | 54W, 5238lm, 3000K / 4000K | 1147P95L4 color 1 |

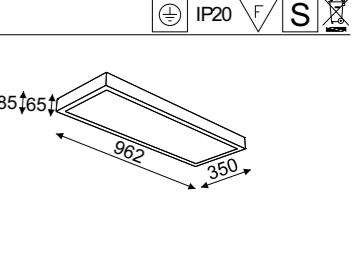

Noble prostokąt IV plafon / ceiling rectangle IV

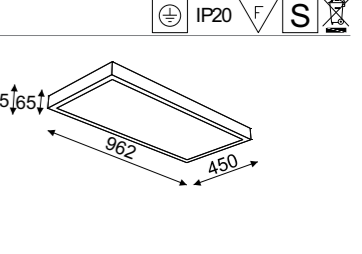

| Symbol | Specyfikacja | Index |
|--------|----------------------------|-----------------------------|
| | 3x 21W, 230V, 50Hz | 1147P93 color 1 |
| | 3x 39W, 230V, 50Hz | 1147P94 color 1 |
| | 81W, 7857lm, 3000K / 4000K | 1147P93D2 color 1 |



Noble



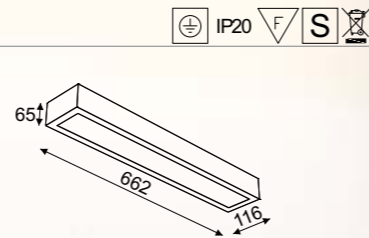

Noble kinkiet I / wall lamp I

| | | Index |
|--|----------------------------|-----------------------------|
|  G5 | 1x 14W, 230V, 50Hz | 1147K61 color 1 |
|  G5 | 1x 24W, 230V, 50Hz | 1147K62 color 1 |
|  LED ECO | 18W, 1746lm, 3000K / 4000K | 1147K61L6 color 1 |



Noble kinkiet II / wall lamp II

| | | Index |
|--|----------------------------|-----------------------------|
|  G5 | 1x 21W, 230V, 50Hz | 1147K91 color 1 |
|  G5 | 1x 39W, 230V, 50Hz | 1147K92 color 1 |
|  LED ECO | 27W, 2619lm, 3000K / 4000K | 1147K91L7 color 1 |

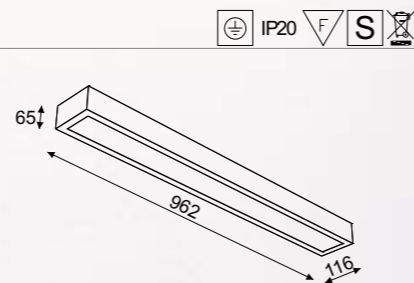

Noble

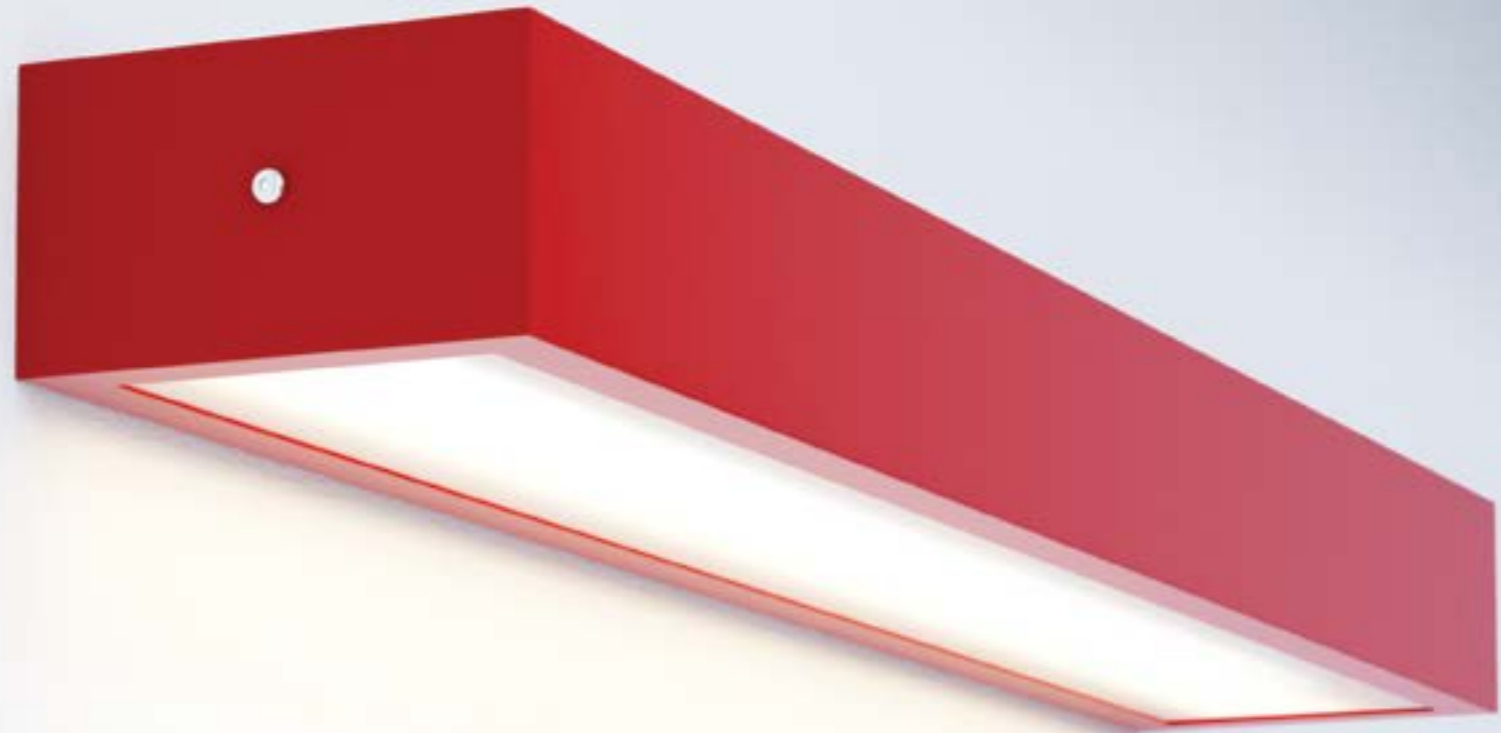

Noble kinkiet I / wall lamp I

| | | Index |
|---|----------------------------|-----------------------------|
|  G5 | 1x 14W, 230V, 50Hz | 1147K63 color 1 |
|  G5 | 1x 24W, 230V, 50Hz | 1147K64 color 1 |
|  LED ECO | 18W, 1746lm, 3000K / 4000K | 1147K63L6 color 1 |

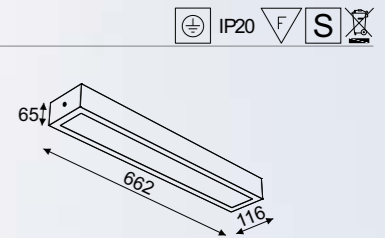

Noble kinkiet II / wall lamp II

| | | Index |
|---|----------------------------|-----------------------------|
|  G5 | 1x 21W, 230V, 50Hz | 1147K93 color 1 |
|  G5 | 1x 39W, 230V, 50Hz | 1147K94 color 1 |
|  LED ECO | 27W, 2619lm, 3000K / 4000K | 1147K93L7 color 1 |

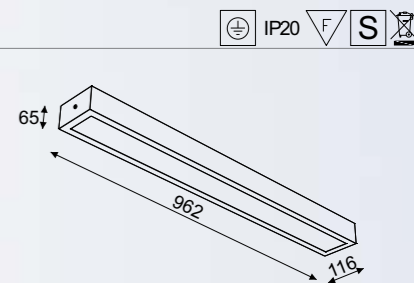



Fox 280 wiszący / hanging lamp



2x max 60W, 230V, 50Hz

Index

1138W1
color 1



19W, 2066lm, 3000K / 4000K

1138W1L1
color 1

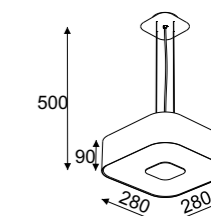

Fox 350 wiszący / hanging lamp



4x max 60W, 230V, 50Hz

Index

1138W2
color 1



19W, 2066lm, 3000K / 4000K

1138W2L1
color 1

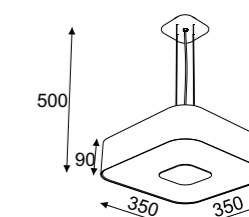
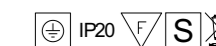

Fox 400 wiszący / hanging lamp



4x max 60W, 230V, 50Hz

Index

1138W3
color 1



25W, 2755lm, 3000K / 4000K

1138W3L2
color 1

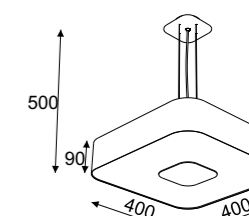
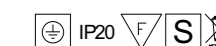

Fox 500 wiszący / hanging lamp



4x max 60W, 230V, 50Hz

Index

1138W4
color 1



25W, 2755lm, 3000K / 4000K

1138W4L2
color 1



32W, 3444lm, 3000K / 4000K

1138W4L3
color 1

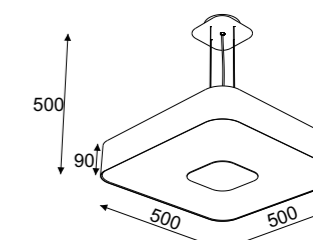
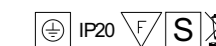

Fox 600 wiszący / hanging lamp



4x max 60W, 230V, 50Hz

Index

1138W5
color 1



32W, 3444lm, 3000K / 4000K

1138W5L3
color 1



54W, 5238lm, 3000K / 4000K

1138W5L4
color 1

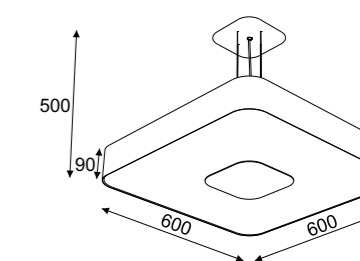
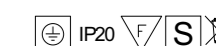

Fox 700 wiszący / hanging lamp



4 x max 60W, 230V, 50Hz

Index

1138W6
color 1



32W, 3444lm, 3000K / 4000K

1138W6L3
color 1



54W, 5238lm, 3000K / 4000K

1138W6L4
color 1

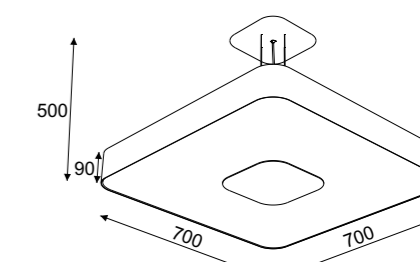
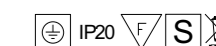

Fox



Fox 280 plafon / ceiling lamp



2x max 60W, 230V, 50Hz

Index
1138P1
color 1



19W, 2066lm, 3000K / 4000K

1138P1L1
color 1

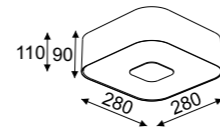
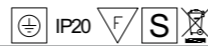

Fox 350 plafon / ceiling lamp

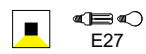

3x max 60W, 230V, 50Hz

Index
1138P2
color 1



19W, 2066lm, 3000K / 4000K

1138P2L1
color 1

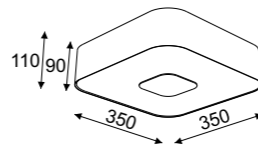
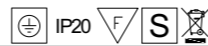

Fox 400 plafon / ceiling lamp



3 x max 60W, 230V, 50Hz

Index
1138P3
color 1



25W, 2755lm, 3000K / 4000K

1138P3L2
color 1

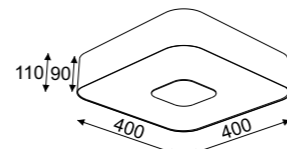
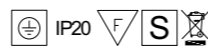

Fox 500 plafon / ceiling lamp



4x max 60W, 230V, 50Hz

Index
1138P4
color 1



25W, 2755lm, 3000K / 4000K

1138P4L2
color 1



32W, 3444lm, 3000K / 4000K

1138P4L3
color 1

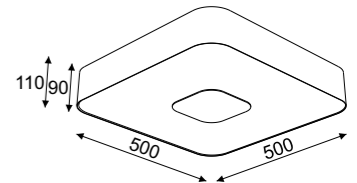

Fox 600 plafon / ceiling lamp



4x max 60W, 230V, 50Hz

Index
1138P5
color 1



32W, 3444lm, 3000K / 4000K

1138P5L3
color 1



54W, 5238lm, 3000K / 4000K

1138P5L4
color 1

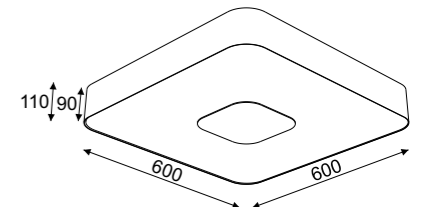

Fox 700 plafon / ceiling lamp



4x max 60W, 230V, 50Hz

Index
1138P6
color 1



32W, 3444lm, 3000K / 4000K

1138P6L3
color 1



54W, 5238lm, 3000K / 4000K

1138P6L4
color 1

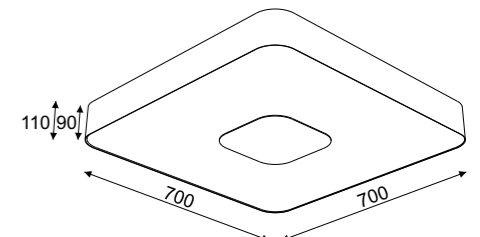

Savana



Savana 280 wisząca / hanging lamp

| | | |
|--|----------------------------|----------------------------|
| | 1x 22W, 230V, 50Hz | 1137W1 color 1 |
| | 19W, 2066lm, 3000K / 4000K | 1137W1L1 color 1 |

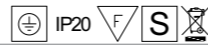
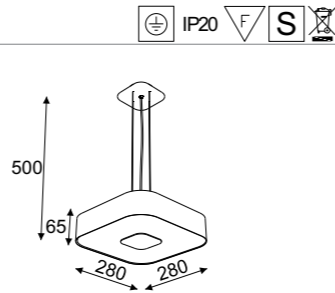

Savana 350 wisząca / hanging lamp

| | | |
|--|----------------------------|----------------------------|
| | 1x 22W, 230V, 50Hz | 1137W2 color 1 |
| | 19W, 2066lm, 3000K / 4000K | 1137W2L1 color 1 |

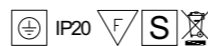
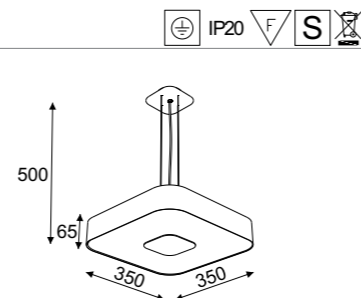

Savana 400 wisząca / hanging lamp

| | | |
|--|----------------------------|----------------------------|
| | 1x 40W, 230V, 50Hz | 1137W3 color 1 |
| | 1x 55W, 230V, 50Hz | 1137W4 color 1 |
| | 25W, 2755lm, 3000K / 4000K | 1137W3L2 color 1 |

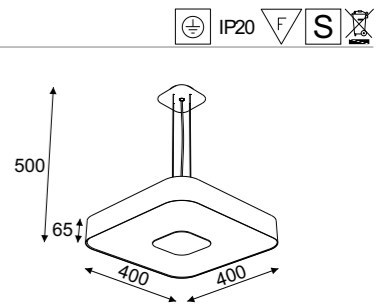

Savana 500 wisząca / hanging lamp

| | | |
|--|----------------------------|----------------------------|
| | 1x 40W, 230V, 50Hz | 1137W5 color 1 |
| | 1x 55W, 230V, 50Hz | 1137W6 color 1 |
| | 25W, 2755lm, 3000K / 4000K | 1137W5L2 color 1 |
| | 32W, 3444lm, 3000K / 4000K | 1137W5L3 color 1 |

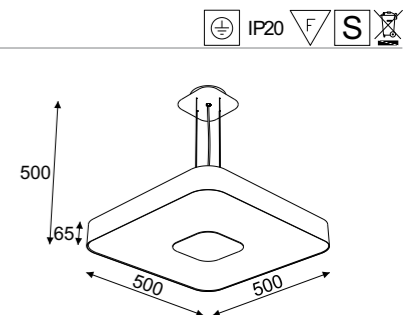

Savana 600 wisząca / hanging lamp

| | | |
|--|----------------------------|----------------------------|
| | 4x 22W, 230V, 50Hz | 1137W7 color 1 |
| | 32W, 3444lm, 3000K / 4000K | 1137W7L3 color 1 |
| | 54W, 5238lm, 3000K / 4000K | 1137W7L4 color 1 |

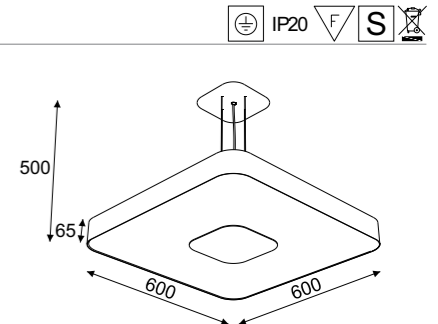

Savana 700 wisząca / hanging lamp

| | | |
|--|----------------------------|----------------------------|
| | 4x 40W, 230V, 50Hz | 1137W8 color 1 |
| | 4x 55W, 230V, 50Hz | 1137W9 color 1 |
| | 32W, 3444lm, 3000K / 4000K | 1137W8L3 color 1 |
| | 54W, 5238lm, 3000K / 4000K | 1137W8L4 color 1 |

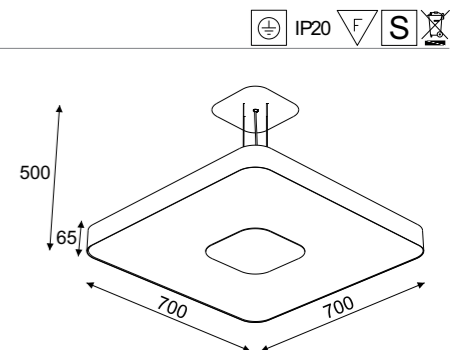

Savana



Savana 280 plafon / ceiling lamp



2GX13

1x 22W, 230V, 50Hz

Index

1137P1
color 1



LED ECO

19W, 2066lm, 3000K / 4000K

1137P1L1
color 1

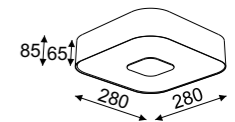
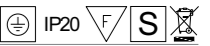

Savana 350 plafon / ceiling lamp



2GX13

1x 22W, 230V, 50Hz

Index

1137P2
color 1



LED ECO

19W, 2066lm, 3000K / 4000K

1137P2L1
color 1

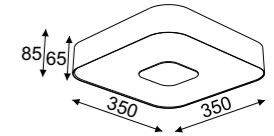

Savana 400 plafon / ceiling lamp



2GX13

1x 40W, 230V, 50Hz

Index

1137P3
color 1



2GX13

1x 55W, 230V, 50Hz

1137P4
color 1



LED ECO

25W, 2755lm, 3000K / 4000K

1137P3L2
color 1

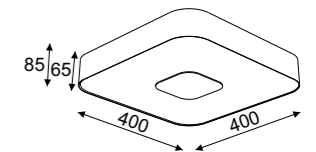

Savana 500 plafon / ceiling lamp



2GX13

1x 40W, 230V, 50Hz

Index

1137P5
color 1



2GX13

1x 55W, 230V, 50Hz

1137P6
color 1



LED ECO

25W, 2755lm, 3000K / 4000K

1137P5L2
color 1



LED ECO

32W, 3444lm, 3000K / 4000K

1137P5L3
color 1

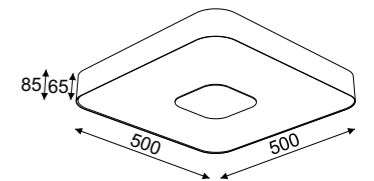

Savana 600 plafon / ceiling lamp



2GX13

4x 22W, 230V, 50Hz

Index

1137P7
color 1



LED ECO

32W, 3444lm, 3000K / 4000K

1137P7L3
color 1



LED ECO

54W, 5283lm, 3000K / 4000K

1137P7L4
color 1

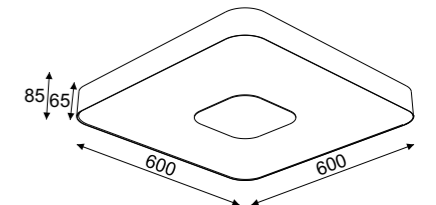

Savana 700 plafon / ceiling lamp



2GX13

4x 40W, 230V, 50Hz

Index

1137P8
color 1



2GX13

4x 55W, 230V, 50Hz

1137P9
color 1



LED ECO

32W, 3444lm, 3000K / 4000K

1137P8L3
color 1



LED ECO

54W, 5238lm, 3000K / 4000K

1137P8L4
color 1

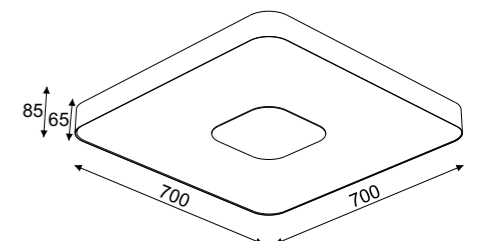



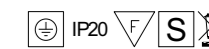

Goes wiszący kwadrat I / hanging square I

Index





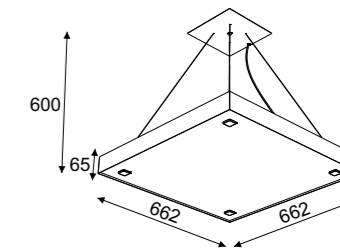

| | | |
|---|----------------------------|-----------------------------|
|  G5 | 4x 14W, 230V, 50Hz | 1148W61 color 1 |
|  G5 | 4x 24W, 230V, 50Hz | 1148W62 color 1 |
|  LED ECO | 72W, 6984lm, 3000K / 4000K | 1148W61L8 color 1 |

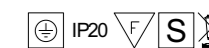

Goes wiszący kwadrat II / hanging square II

Index





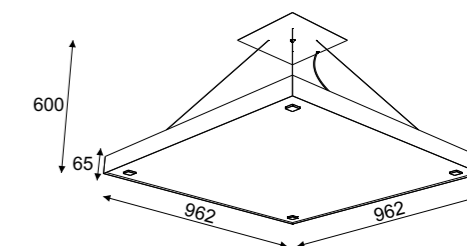

| | | |
|---|------------------------------|-----------------------------|
|  G5 | 6x 21W, 230V, 50Hz | 1148W91 color 1 |
|  G5 | 6x 39W, 230V, 50Hz | 1148W92 color 1 |
|  LED ECO | 162W, 15714lm, 3000K / 4000K | 1148W91L9 color 1 |

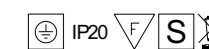

Goes plafon kwadrat I / ceiling square I

Index





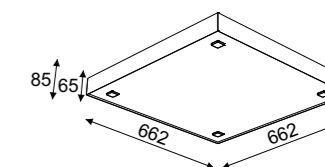

| | | |
|---|----------------------------|-----------------------------|
|  G5 | 4x 14W, 230V, 50Hz | 1148P61 color 1 |
|  G5 | 4x 24W, 230V, 50Hz | 1148P62 color 1 |
|  LED ECO | 72W, 6984lm, 3000K / 4000K | 1148P61L8 color 1 |

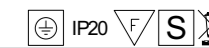

Goes plafon kwadrat II / ceiling square II

Index





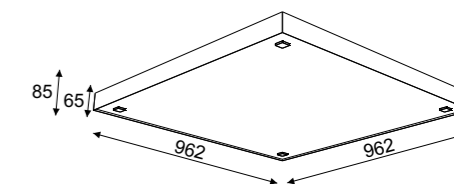

| | | |
|---|------------------------------|-----------------------------|
|  G5 | 6x 21W, 230V, 50Hz | 1148P91 color 1 |
|  G5 | 6x 39W, 230V, 50Hz | 1148P92 color 1 |
|  LED ECO | 162W, 15714lm, 3000K / 4000K | 1148P91L9 color 1 |

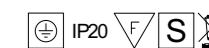

Goes kinkiet I / wall lamp I

Index





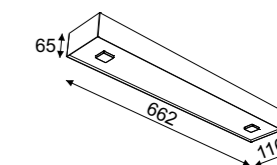

| | | |
|---|----------------------------|-----------------------------|
|  G5 | 1x 14W, 230V, 50Hz | 1148K61 color 1 |
|  G5 | 1x 24W, 230V, 50Hz | 1148K62 color 1 |
|  LED ECO | 18W, 1746lm, 3000K / 4000K | 1148K61L6 color 1 |

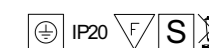

Goes kinkiet II / wall lamp II

Index



| | | |
|---|----------------------------|-----------------------------|
|  G5 | 1x 21W, 230V, 50Hz | 1148K91 color 1 |
|  G5 | 1x 39W, 230V, 50Hz | 1148K92 color 1 |
|  LED ECO | 27W, 2619lm, 3000K / 4000K | 1148K91L7 color 1 |

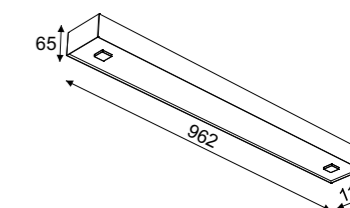

Goes



Goes



Goes prostokąt I wiszący / hanging rectangle I

Index



| | | |
|--|----------------------------|-----------------------------|
| | 2x 14W, 230V, 50Hz | 1148W65 color 1 |
| | 2x 24W, 230V, 50Hz | 1148W66 color 1 |
| | 36W, 3492lm, 3000K / 4000K | 1148W65D1 color 1 |

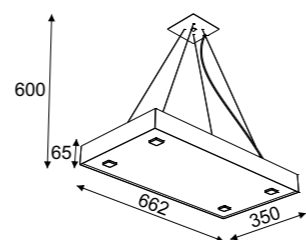

Goes prostokąt I plafon / ceiling rectangle I

Index

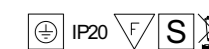

| | | |
|--|----------------------------|-----------------------------|
| | 2x 14W, 230V, 50Hz | 1148P65 color 1 |
| | 2x 24W, 230V, 50Hz | 1148P66 color 1 |
| | 36W, 3492lm, 3000K / 4000K | 1148P65D1 color 1 |

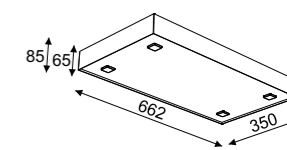

Goes prostokąt II wiszący / hanging rectangle II

Index

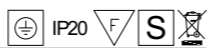

| | | |
|--|----------------------------|-----------------------------|
| | 3x 14W, 230V, 50Hz | 1148W63 color 1 |
| | 3x 24W, 230V, 50Hz | 1148W64 color 1 |
| | 54W, 5238lm, 3000K / 4000K | 1148W63L4 color 1 |

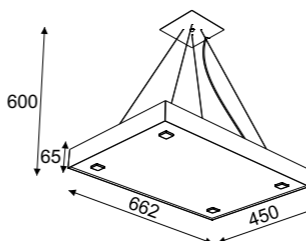

Goes prostokąt II plafon / ceiling rectangle II

Index

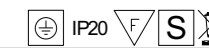

| | | |
|--|----------------------------|-----------------------------|
| | 3x 14W, 230V, 50Hz | 1148P63 color 1 |
| | 3x 24W, 230V, 50Hz | 1148P64 color 1 |
| | 54W, 5238lm, 3000K / 4000K | 1148P63L4 color 1 |

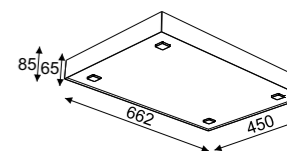

Goes prostokąt III wiszący / hanging rectangle III

Index



| | | |
|--|----------------------------|-----------------------------|
| | 2x 21W, 230V, 50Hz | 1148W95 color 1 |
| | 2x 39W, 230V, 50Hz | 1148W96 color 1 |
| | 54W, 5238lm, 3000K / 4000K | 1148W95L4 color 1 |

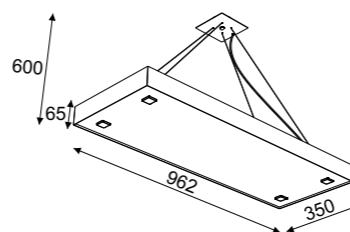

Goes prostokąt III plafon / ceiling rectangle III

Index

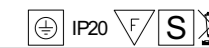

| | | |
|--|----------------------------|-----------------------------|
| | 2x 21W, 230V, 50Hz | 1148P95 color 1 |
| | 2x 39W, 230V, 50Hz | 1148P96 color 1 |
| | 54W, 5238lm, 3000K / 4000K | 1148P95L4 color 1 |

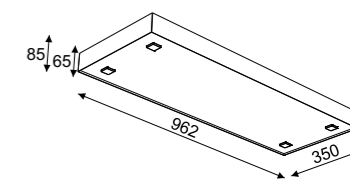

Goes prostokąt IV wiszący / hanging rectangle IV

Index

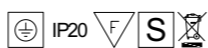

| | | |
|--|----------------------------|-----------------------------|
| | 3x 21W, 230V, 50Hz | 1148W93 color 1 |
| | 3x 39W, 230V, 50Hz | 1148W94 color 1 |
| | 81W, 7857lm, 3000K / 4000K | 1148W93D2 color 1 |

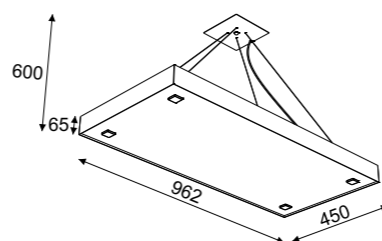

Goes prostokąt IV plafon / ceiling rectangle IV

Index

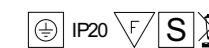

| | | |
|--|----------------------------|-----------------------------|
| | 3x 21W, 230V, 50Hz | 1148P93 color 1 |
| | 3x 39W, 230V, 50Hz | 1148P94 color 1 |
| | 81W, 7857lm, 3000K / 4000K | 1148P93D2 color 1 |

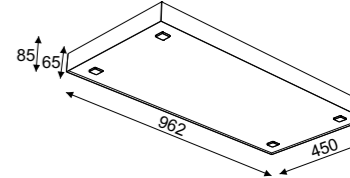

Argon



Argon plafon kwadrat I / ceiling square I

| Icon | Power / Lumens | Index |
|---------|----------------------------|-----------------------------|
| G5 | 4x 14W, 230V, 50Hz | 1151P61 color 1 |
| G5 | 4x 24W, 230V, 50Hz | 1151P62 color 1 |
| LED ECO | 72W, 6984lm, 3000K / 4000K | 1151P61L8 color 1 |

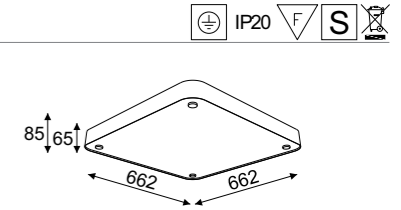

Argon plafon kwadrat II / ceiling square II

| Icon | Power / Lumens | Index |
|---------|------------------------------|-----------------------------|
| G5 | 6x 21W, 230V, 50Hz | 1151P91 color 1 |
| G5 | 6x 39W, 230V, 50Hz | 1151P92 color 1 |
| LED ECO | 162W, 15714lm, 3000K / 4000K | 1151P91L9 color 1 |

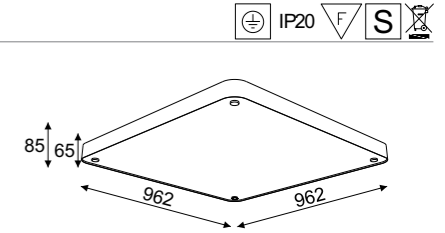

Argon kinkiet I / wall lamp I

| Icon | Power / Lumens | Index |
|---------|----------------------------|-----------------------------|
| G5 | 1x 14W, 230V, 50Hz | 1151K61 color 1 |
| G5 | 1x 24W, 230V, 50Hz | 1151K62 color 1 |
| LED ECO | 18W, 1746lm, 3000K / 4000K | 1151K61L6 color 1 |

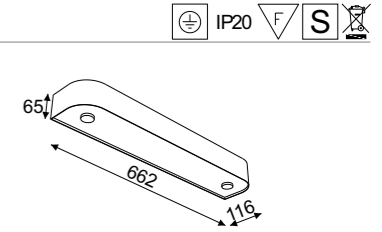

Argon kinkiet II / wall lamp II

| Icon | Power / Lumens | Index |
|---------|----------------------------|-----------------------------|
| G5 | 1x 21W, 230V, 50Hz | 1151K91 color 1 |
| G5 | 1x 39W, 230V, 50Hz | 1151K92 color 1 |
| LED ECO | 27W, 2619lm, 3000K / 4000K | 1151K91L7 color 1 |

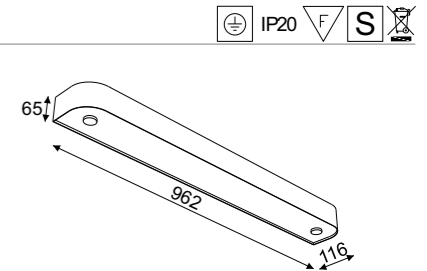

Argon wiszący kwadrat I / hanging square I

| Icon | Power / Lumens | Index |
|---------|----------------------------|-----------------------------|
| G5 | 4x 14W, 230V, 50Hz | 1151W61 color 1 |
| G5 | 4x 24W, 230V, 50Hz | 1151W62 color 1 |
| LED ECO | 72W, 6984lm, 3000K / 4000K | 1151W61L8 color 1 |

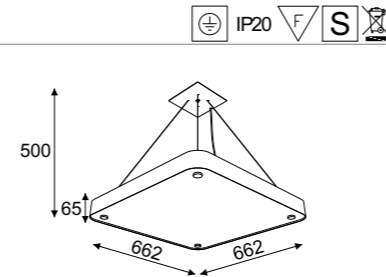

Argon wiszący kwadrat II / hanging square II

| Icon | Power / Lumens | Index |
|---------|------------------------------|-----------------------------|
| G5 | 6x 21W, 230V, 50Hz | 1151W91 color 1 |
| G5 | 6x 39W, 230V, 50Hz | 1151W92 color 1 |
| LED ECO | 162W, 15714lm, 3000K / 4000K | 1151W91L9 color 1 |

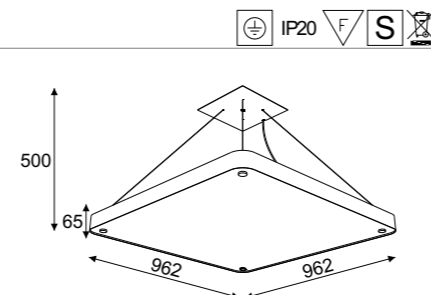



Argon

Argon prostokąt III wiszący / hanging rectangle III

Index



| | | | |
|--|---------|----------------------------|-----------------------------|
| | G5 | 2x 21W, 230V, 50Hz | 1151W95 color 1 |
| | G5 | 2x 39W, 230V, 50Hz | 1151W96 color 1 |
| | LED ECO | 54W, 5238lm, 3000K / 4000K | 1151W95L4 color 1 |

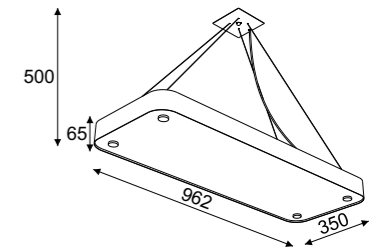

Argon prostokąt IV wiszący / hanging rectangle IV

Index



| | | | |
|--|---------|----------------------------|-----------------------------|
| | G5 | 3x 21W, 230V, 50Hz | 1151W93 color 1 |
| | G5 | 3x 39W, 230V, 50Hz | 1151W94 color 1 |
| | LED ECO | 81W, 7857lm, 3000K / 4000K | 1151W93D2 color 1 |

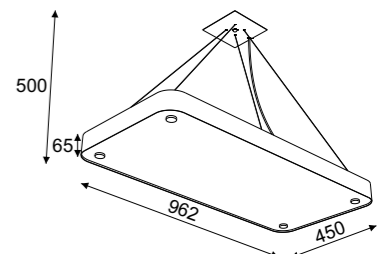

Argon prostokąt I plafon / ceiling rectangle I

Index



| | | | |
|--|---------|----------------------------|-----------------------------|
| | G5 | 2x 14W, 230V, 50Hz | 1151P65 color 1 |
| | G5 | 2x 24W, 230V, 50Hz | 1151P66 color 1 |
| | LED ECO | 36W, 3492lm, 3000K / 4000K | 1151P65D1 color 1 |

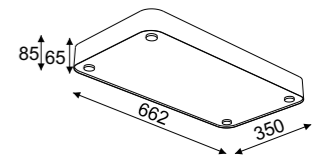

Argon prostokąt II plafon / ceiling rectangle II

Index



| | | | |
|--|---------|----------------------------|-----------------------------|
| | G5 | 3x 14W, 230V, 50Hz | 1151P63 color 1 |
| | G5 | 3x 24W, 230V, 50Hz | 1151P64 color 1 |
| | LED ECO | 54W, 5238lm, 3000K / 4000K | 1151P63L4 color 1 |

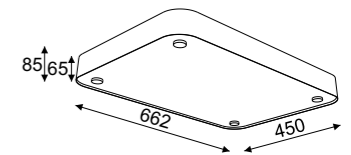

Argon prostokąt I wiszący / hanging rectangle I

Index



| | | | |
|--|---------|----------------------------|-----------------------------|
| | G5 | 2x 14W, 230V, 50Hz | 1151W65 color 1 |
| | G5 | 2x 24W, 230V, 50Hz | 1151W66 color 1 |
| | LED ECO | 36W, 3492lm, 3000K / 4000K | 1151W65D1 color 1 |

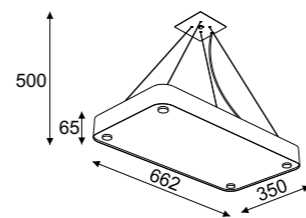

Argon prostokąt III plafon / ceiling rectangle III

Index



| | | | |
|--|---------|----------------------------|-----------------------------|
| | G5 | 2x 21W, 230V, 50Hz | 1151P95 color 1 |
| | G5 | 2x 39W, 230V, 50Hz | 1151P96 color 1 |
| | LED ECO | 54W, 5238lm, 3000K / 4000K | 1151P95L4 color 1 |

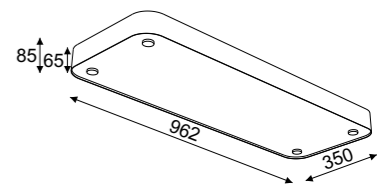

Argon prostokąt II wiszący / hanging rectangle II

Index

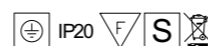

| | | | |
|--|---------|----------------------------|-----------------------------|
| | G5 | 3x 14W, 230V, 50Hz | 1151W63 color 1 |
| | G5 | 3x 24W, 230V, 50Hz | 1151W64 color 1 |
| | LED ECO | 54W, 5238lm, 3000K / 4000K | 1151W63L4 color 1 |

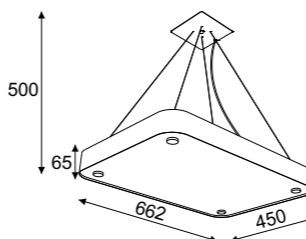

Argon prostokąt IV plafon / ceiling rectangle IV

Index



| | | | |
|--|---------|----------------------------|-----------------------------|
| | G5 | 3x 21W, 230V, 50Hz | 1151P93 color 1 |
| | G5 | 3x 39W, 230V, 50Hz | 1151P94 color 1 |
| | LED ECO | 81W, 7857lm, 3000K / 4000K | 1151P93D2 color 1 |

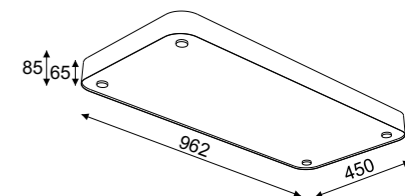

Oprawy z betonu architektonicznego

Lekkość, która zaskakuje.

Efektorem ciągłego dążenia ku innowacyjności jest stworzenie przez nas pilnie strzeżonej mieszanki o nazwie Cementocardona. Jej wygląd zewnętrzny i faktura do złudzenia przypominają tradycyjny beton, lecz jest od niego aż o 50% lżejsza. Osiągnięcie takiego wyniku pozwoliło nam na szerokie wykorzystanie tego materiału w produkcji oryginalnych opraw oświetleniowych. Zaprojektowane przez nas formy doskonale współgrają z nieco surowym charakterem Cementocardony - są proste, minimalistyczne oraz dobrze znane i cenione przez użytkowników. Świetnie sprawdzają się we wnętrzach o industrialnym charakterze.

Luminaires made architectural concrete

The lightness that surprises.

The result of constantly striving towards innovation is the result of our closely guarded mix, called Cementocardona. Its appearance and texture are confusingly similar to those of traditional concrete, but it is up to 50% lighter. Achieving such a result has allowed us the widespread use of this material in the production of our original lighting fixtures. Shapes designed by us perfectly harmonize with the slightly harsh characteristics of Cementocardona - they are simple, minimalist, well-known, and appreciated by users. Very well suited for industrial interiors.



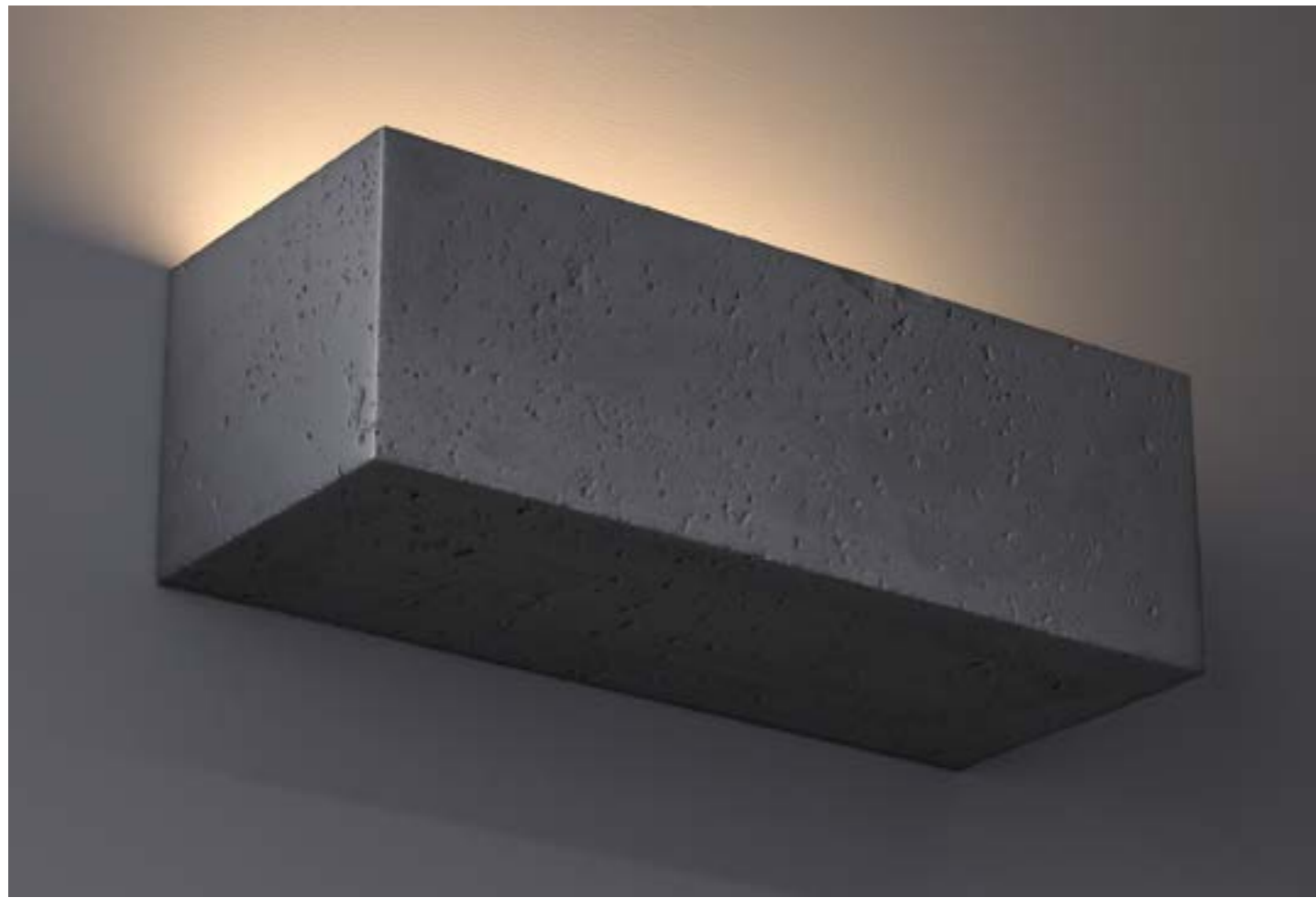

Korytko 12 wysokie pełne / high and full

| | | | |
|--|----------------------------|-----------------------------------|--|
| | 1x max 40W, 230V, 50Hz | 6610/betb color 16... | |
| | 4,5W, 437lm, 3000K / 4000K | 6610N2/betb color 16... | |

Korytko 30 wysokie pełne / high and full

| | | | |
|--|--------------------------|-----------------------------------|--|
| | 1x max 23W, 230V, 50Hz | 6620/betb color 16... | |
| | 9W, 873lm, 3000K / 4000K | 6620L5/betb color 16... | |

Korytko 50 wysokie pełne / high and full

| | | | |
|--|--------------------------|-----------------------------------|--|
| | 1x max 23W, 230V, 50Hz | 6630/betb color 16... | |
| | 9W, 873lm, 3000K / 4000K | 6630L5/betb color 16... | |

Korytko 60 niskie pełne / low and full

| | | | |
|--|----------------------------|-----------------------------------|--|
| | 1x max 23W, 230V, 50Hz | 6674/betb color 16... | |
| | 18W, 1746lm, 3000K / 4000K | 6674L6/betb color 16... | |



Korytko 12 wysokie z dolnym szkłem / high with bottom glass

| | | | |
|--|--------------------------|-----------------------------------|--|
| | 1x max 40W, 230V, 50Hz | 6810/betb color 16... | |
| | 9W, 873lm, 3000K / 4000K | 6810K7/betb color 16... | |

Korytko 30 wysokie z dolnym szkłem / high with bottom glass

| | | | |
|--|--------------------------|-----------------------------------|--|
| | 1x max 23W, 230V, 50Hz | 6820/betb color 16... | |
| | 9W, 873lm, 3000K / 4000K | 6820L5/betb color 16... | |

Korytko 50 wysokie z dolnym szkłem / high with bottom glass

| | | | |
|--|--------------------------|-----------------------------------|--|
| | 1x max 23W, 230V, 50Hz | 6830/betb color 16... | |
| | 9W, 873lm, 3000K / 4000K | 6830L5/betb color 16... | |

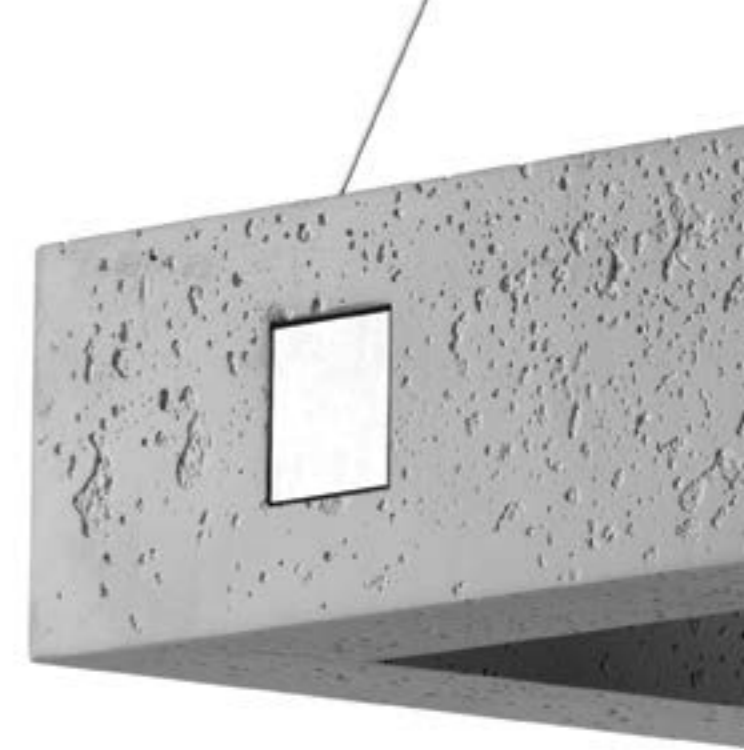

Geo 600 wisząca / hanging lamp

Index

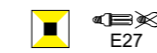

4x max 23W, 230V, 50Hz

1175W6A/betm
color 16...



32W, 3444lm, 3000K / 4000K

1175W6AL3/betm
color 16...

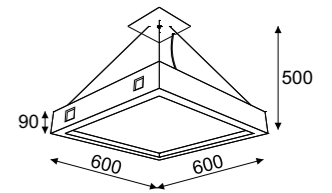

Geo 340 wisząca / hanging lamp

Index



2x max 23W, 230V, 50Hz

1175W3B/betm
color 16...



19W, 2066lm, 3000K / 4000K

1175W3L1/betm
color 16...

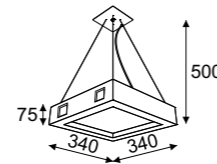

Geo 800 wisząca / hanging lamp

Index

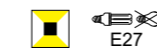

8x max 23W, 230V, 50Hz

1175W8B/betm
color 16...



72W, 6984lm, 3000K / 4000K

1175W8L8/betm
color 16...



108W, 10476lm, 3000K / 4000K

1175W8D4/betm
color 16...

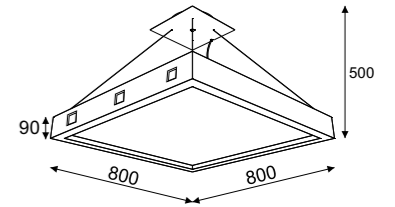

Geo 500 wisząca / hanging lamp

Index



4x max 23W, 230V, 50Hz

1770/betm
color 16...



1x 40W, 230V, 50Hz

1770W5C/betm
color 16...



25W, 2755lm, 3000K / 4000K

1770L2/betm
color 16...

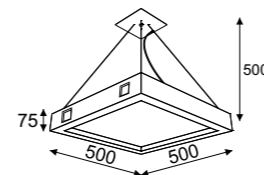

Geo 1000 wisząca / hanging lamp

Index

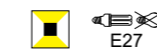

12x max 23W, 230V, 50Hz

1175W10A/betm
color 16...



135W, 13095lm, 3000K / 4000K

1175W10N1/betm
color 16...

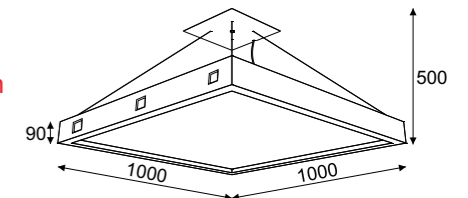

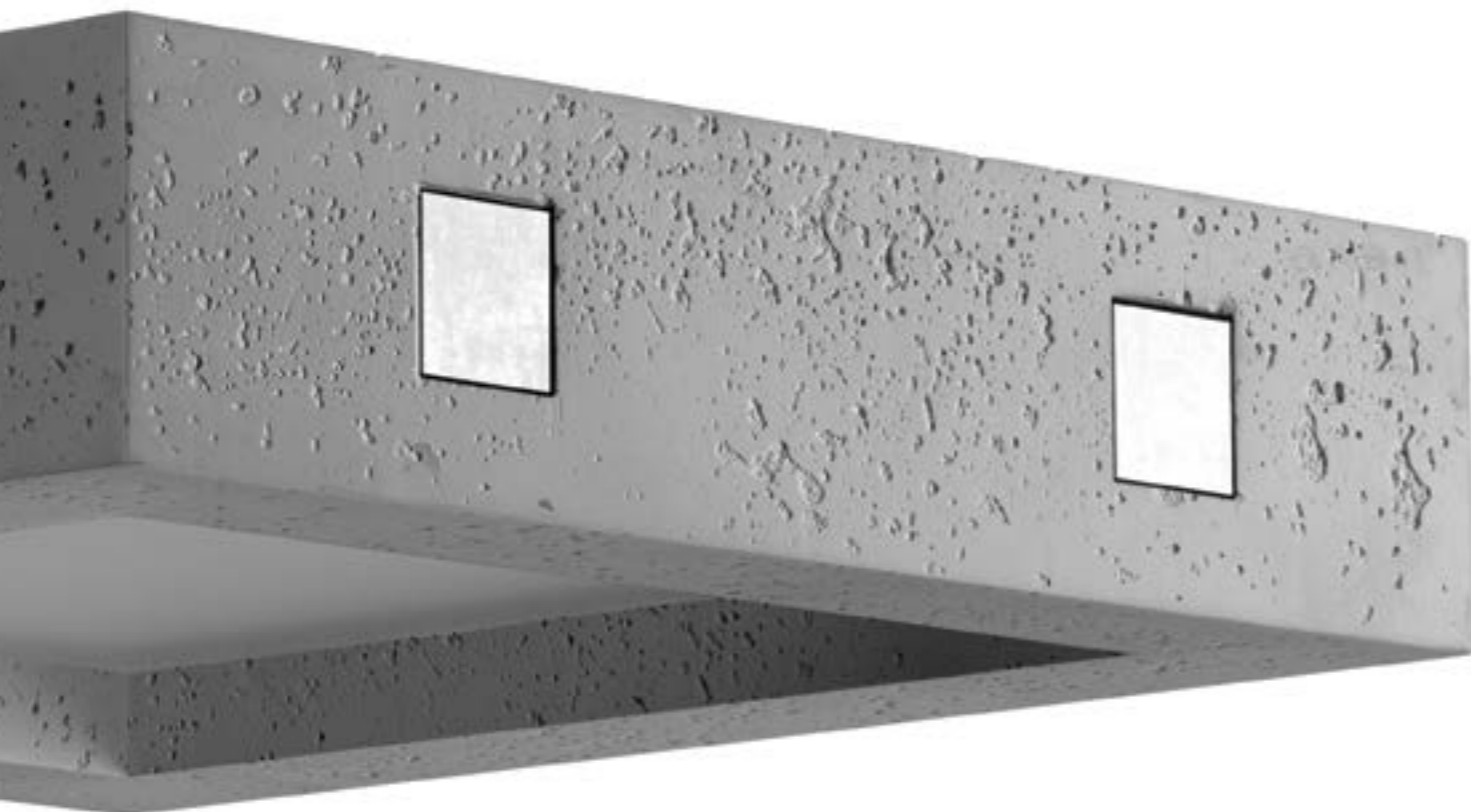



Geo 340 plafon / ceiling lamp

Index





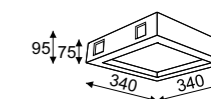

| | | |
|---|----------------------------|------------------------------------|
|  E27 | 1x max 23W, 230V, 50Hz | 1774/betm color 16... |
|  2GX13 | 1x 22W, 230V, 50Hz | 1774P3C/betm color 16... |
|  LED ECO | 19W, 2066lm, 3000K / 4000K | 1774L1/betm color 16... |



Geo 500 plafon / ceiling lamp

Index





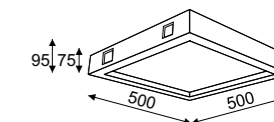

| | | |
|---|----------------------------|------------------------------------|
|  E27 | 4x max 23W, 230V, 50Hz | 1772/betm color 16... |
|  2GX13 | 1 x 40W, 230V, 50Hz | 1772P5C/betm color 16... |
|  2GX13 | 1x 55W, 230V, 50Hz | 1772P5D/betm color 16... |
|  LED ECO | 25W, 2755lm, 3000K / 4000K | 1772L2/betm color 16... |



Geo 600 plafon / ceiling lamp

Index





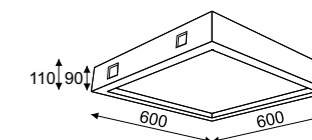

| | | |
|---|----------------------------|-------------------------------------|
|  E27 | 4x max 23W, 230V, 50Hz | 1175P6A/betm color 16... |
|  2GX13 | 1x 40W, 230V, 50Hz | 1775P6B/betm color 16... |
|  2GX13 | 1x 55W, 230V, 50Hz | 1175P6C/betm color 16... |
|  LED ECO | 32W, 3444lm, 3000K / 4000K | 1175P6L3/betm color 16... |



Geo 800 plafon / ceiling lamp

Index





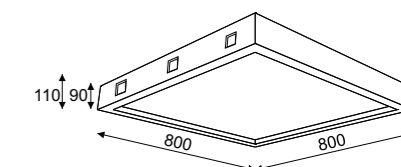

| | | |
|---|------------------------------|-------------------------------------|
|  E27 | 8x max 23W, 230V, 50Hz | 1175P8B/betm color 16... |
|  2GX13 | 4x 22W, 230V, 50Hz | 1175P8C/betm color 16... |
|  G5 | 4x 14W, 230V, 50Hz | 1175P8D/betm color 16... |
|  LED ECO | 72W, 6984lm, 3000K / 4000K | 1175P8L8/betm color 16... |
|  LED ECO | 108W, 10476lm, 3000K / 4000K | 1175P8D4/betm color 16... |



Geo 1000 plafon / ceiling lamp

Index



| | | |
|---|------------------------------|--------------------------------------|
|  E27 | 12x max 23W, 230V, 50Hz | 1175P10A/betm color 16... |
|  2GX13 | 4x 40W, 230V, 50Hz | 1175P10B/betm color 16... |
|  2G11 | 8x 24W, 230V, 50Hz | 1175P10D/betm color 16... |
|  LED ECO | 135W, 13095lm, 3000K / 4000K | 1175P10N1/betm color 16... |

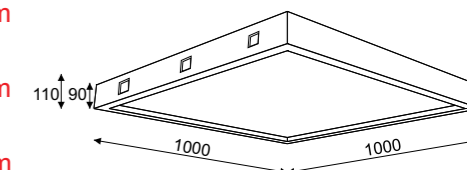



Omega 380 wisząca / hanging lamp

Index



E27

3x max 23W, 230V, 50Hz **1171W3A/betm**
color 16...



LED ECO

19W, 2066lm, 3000K / 4000K **1171W3L1/betm**
color 16...

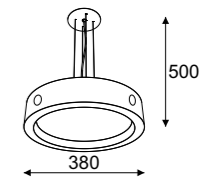

Omega 440 wisząca / hanging lamp

Index



E27

3x max 23W, 230V, 50Hz **1171W4A/betm**
color 16...



LED ECO

25W, 2755lm, 3000K / 4000K **1171W4L2/betm**
color 16...

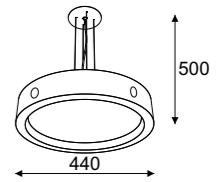

Omega 500 wisząca / hanging lamp

Index



E27

3x max 23W, 230V, 50Hz **1171W5A/betm**
color 16...



LED ECO

25W, 2755lm, 3000K / 4000K **1171W5L2/betm**
color 16...

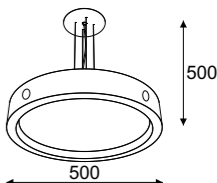

Omega 600 wisząca / hanging lamp

Index



E27

3x max 23W, 230V, 50Hz **1171W6A/betm**
color 16...



E27

6x max 23W, 230V, 50Hz **1171W6B/betm**
color 16...



2GX13

3x 22W, 230V, 50Hz **1171W6C/betm**
color 16...



LED ECO

75W, 8265lm, 3000K / 4000K **1171W6D3/betm**
color 16...

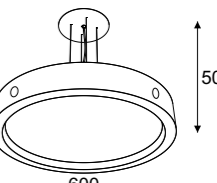

Omega 700 wisząca / hanging lamp

Index



E27

4x max 23W, 230V, 50Hz **1171W7A/betm**
color 16...



2GX13

4x 22W, 230V, 50Hz **1171W7C/betm**
color 16...



LED ECO

75W, 8265lm, 3000K / 4000K **1171W7D3/betm**
color 16...

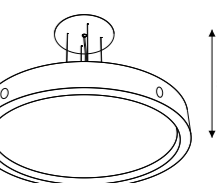

Omega 1000 wisząca / hanging lamp

Index



E27

8x max 23W, 230V, 50Hz **1171W10A/betm**
color 16...



LED ECO

117W, 11349lm, 3000K / 4000K **1171W10D5/betm**
color 16...

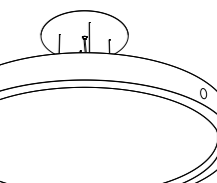

Omega



Omega 380 plafon / ceiling lamp

Index



3x max 23W, 230V, 50Hz

1171P3A/betm
color 16...

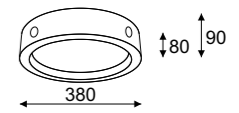

19W, 2066lm, 3000K / 4000K

1171P3L1/betm
color 16...

Omega 440 plafon / ceiling lamp

Index



3x max 23W, 230V, 50Hz

1171P4A/betm
color 16...

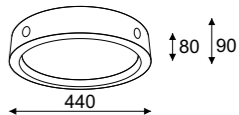

1x 40W, 230V, 50Hz

1171P4B/betm
color 16...



25W, 2755lm, 3000K / 4000K

1171P4L2/betm
color 16...

Omega 500 plafon / ceiling lamp

Index



3x max 23W, 230V, 50Hz

1171P5A/betm
color 16...

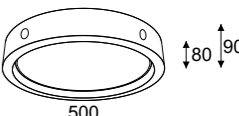

1x 40W, 230V, 50Hz

1171P5B/betm
color 16...



25W, 2755lm, 3000K / 4000K

1171P5L2/betm
color 16...

Omega 600 plafon / ceiling lamp

Index



3x max 23W, 230V, 50Hz

1171P6A/betm
color 16...

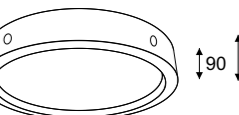

6x max 23W, 230V, 50Hz

1171P6B/betm
color 16...



3x 22W, 230V, 50Hz

1171P6C/betm
color 16...



75W, 8265lm, 3000K / 4000K

1171P6D3/betm
color 16...

Omega 700 plafon / ceiling lamp

Index



4x max 23W, 230V, 50Hz

1171P7A/betm
color 16...



4x 22W, 230V, 50Hz

1171P7C/betm
color 16...



75W, 8265lm, 3000K / 4000K

1171P7D3/betm
color 16...

Omega 1000 plafon / ceiling lamp

Index



8x max 23W, 230V, 50Hz

1171P10A/betm
color 16...



117W, 11349lm, 3000K / 4000K

1171P10D5/betm
color 16...

Omega



Omega 40 betonowa kinkiet / wall lamp

| | | | |
|--|--------------------------|-----------------------------------|--|
| | 1x max 23W, 230V, 50Hz | 1380/betb color 16... | |
| | 9W, 873lm, 3000K / 4000K | 1380L5/betm color 16... | |

Omega 60 betonowa kinkiet / wall lamp

| | | | |
|--|----------------------------|-----------------------------------|--|
| | 2x max 23W, 230V, 50Hz | 1330/betb color 16... | |
| | 18W, 1746lm, 3000K / 4000K | 1330L6/betm color 16... | |



Obraz szkło 40 ścienny Paiting plain glass 40

| | | | |
|--|---|---|--|
| | 2 x 11W, 230V, 50Hz electronic ballast | Index 3840EL/betb color 16... | |
| | | | |

Obraz szkło 50 ścienny Paiting plain glass 50

| | | | |
|--|--|---|--|
| | 2x 11W, 230V, 50Hz electronic ballast | Index 3841EL/betb color 16... | |
| | | | |

Obraz szkło 60 ścienny Paiting plain glass 60

| | | | |
|--|--|---|--|
| | 3x 11W, 230V, 50Hz electronic ballast | Index 3842EL/betb color 16... | |
| | | | |

Obraz pierścienie symetryczne - wersja duża
 Paiting symmetric rings - large version

Index

new ±2% ⊕ IP20 F MB

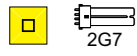

2x 11W, 230V, 50Hz
 electronic ballast

3870EL/betb
 color 16...

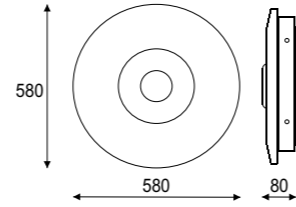

Obraz kwadrat symetryczny
 Paiting symmetric square

Index

new ±2% ⊕ IP20 F MB



2x 11W, 230V, 50Hz
 electronic ballast

3720EL/betb
 color 16...

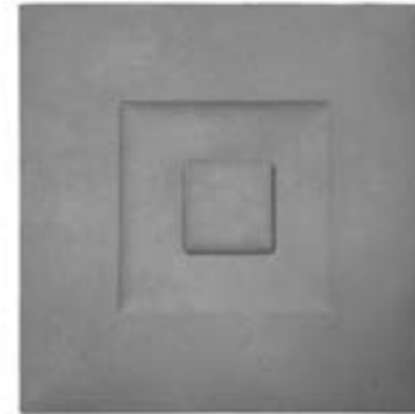
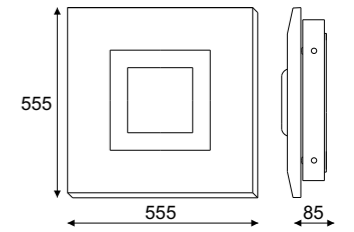

Obraz kwadracik - little square

Index

new ±2% ⊕ IP20 F MB

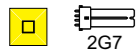

2x 11W, 230V, 50Hz
 electronic ballast

3820EL/betb
 color 16...

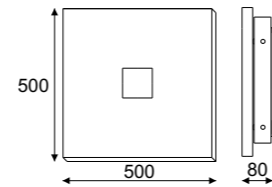

Obraz kopalnia 500 x 500
 Paiting mine 500 X 500

new ±2% ⊕ IP20 F MB



2x 11W, 230V, 50Hz
 electronic ballast

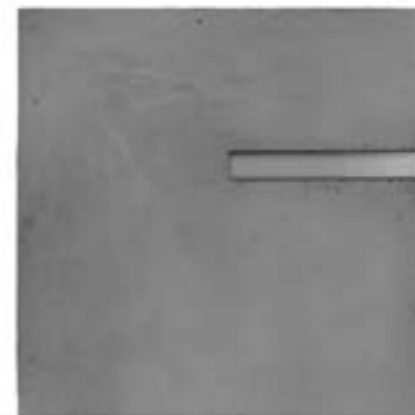
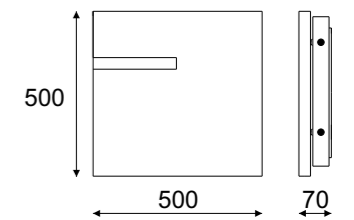

Obraz kwadracik - little square

Index

new ±2% ⊕ IP20 F MB



2x 11W, 230V, 50Hz
 electronic ballast

3821EL/betb
 color 16...

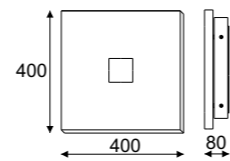

wersja LG

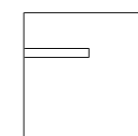

Index
 3071EL/betb
 color 16...

wersja GP

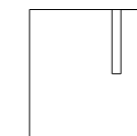

Index
 3061EL/betb
 color 16...

wersja PD

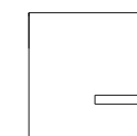

Index
 3051EL/betb
 color 16...

wersja DL

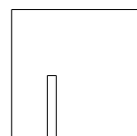

Index
 3081EL/betb
 color 16...

Monax



Monax plafon / ceiling lamp



1x max 13W, 230V, 50Hz

Index

1213P1
color 16...

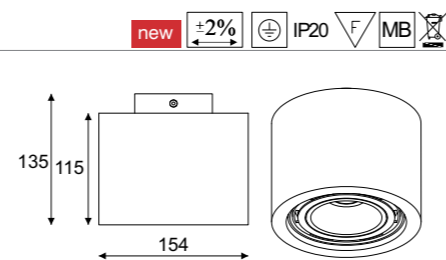

Monax wisząca / hanging lamp



1x max 13W, 230V, 50Hz

Index

1213Z1
color 16...

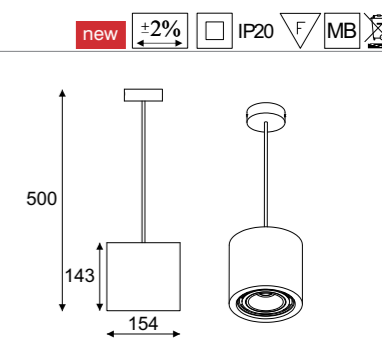

Monax wisząca / hanging lamp



1x max 13W, 230V, 50Hz

Index

1213Z2
color 16...

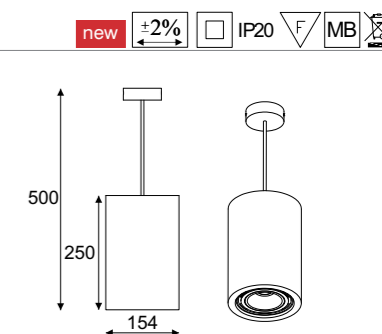



Oprawy z masy gipsowej

Kształty, które intrygują

Bryły opraw wykonanych ze wzmocnionej utwardzaczami mieszanki mas gipsowych potrafią zachwycić i... prawdziwie zaintrygować. Niezależnie od tego czy ich formy są bardziej wymyślne czy też pozbawione wszelkich zdobień - w żadnym wypadku nie można określić ich mianem przeciętnych. ponadczasowy urok lamp gipsowych tkwi w ich delikatności i funkcjonalności, a to cechy, które od lat zachwycają wszystkich lubiących otaczać się przedmiotami pięknymi i użytecznymi zarazem. Oprawy te dostępne są w neutralnym, białym kolorze, co pozwala na dopasowanie ich do wielu przestrzeni mieszkalnych i nie tylko.

Plaster lamps

Shapes that intrigue

Lamp of luminaires made from a mixture of gypsum masses reinforced with hardeners can enchant and... truly intrigue. Regardless of whether their forms are more contrived or devoid of any ornamentation- one cannot describe them as merely „average”. The timeless appeal of plaster lamps lies in their delicacy and functionality. These are qualities that can delight anyone who likes to be surrounded by both beautiful and useful object, for many years to come. These luminaires are available in a neutral white colour, which allows them to fit many residential spaces, and much more...

Geo











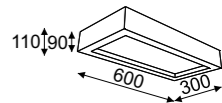



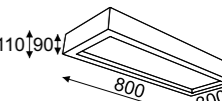



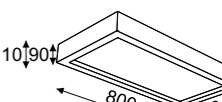



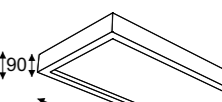



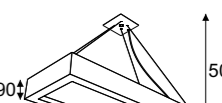

| | | |
|---------------------------------------|------------------------------|------------------|
| Geo 340 plafon / ceiling lamp | Index | |
| E27 | 1x max 23W, 230V, 50Hz | 1774 |
| 2GX13 | 1x 22W, 230V, 50Hz | 1774P3C |
| LED ECO | 19W, 2066lm, 3000K / 4000K | 1774P3L1 |
| 340x340x95 | | |
| Geo 400 plafon / ceiling lamp | Index | |
| E27 | 2x max 23W, 230V, 50Hz | 1773 |
| 2GX13 | 1x 22W, 230V, 50Hz | 1773P4C |
| LED ECO | 25W, 2755lm, 3000K / 4000K | 1773P4L2 |
| 400x400x95 | | |
| Geo 500 plafon / ceiling lamp | Index | |
| E27 | 4x max 23W, 230V, 50Hz | 1772 |
| 2GX13 | 1x 40W, 230V, 50Hz | 1772P5C |
| LED ECO | 25W, 2755lm, 3000K / 4000K | 1773P5L2 |
| 500x500x95 | | |
| Geo 600 plafon / ceiling lamp | Index | |
| E27 | 4x max 23W, 230V, 50Hz | 1175P6A |
| 2GX13 | 1x 40W, 230V, 50Hz | 1175P6B |
| LED ECO | 32W, 3444lm, 3000K / 4000K | 1775P6L3 |
| 600x600x110 | | |
| Geo 700 plafon / ceiling lamp | Index | |
| E27 | 8x max 23W, 230V, 50Hz | 1175P7B |
| LED ECO | 32W, 3444lm, 3000K / 4000K | 1775P7L3 |
| LED ECO | 54W, 5238lm, 3000K / 4000K | 1775P7L4 |
| 700x700x110 | | |
| Geo 800 plafon / ceiling lamp | Index | |
| E27 | 8x max 23W, 230V, 50Hz | 1175P8B |
| LED ECO | 72W, 6984lm, 3000K / 4000K | 1175P8L8 |
| LED ECO | 108W, 10476lm, 3000K / 4000K | 1175P8D4 |
| 800x800x110 | | |
| Geo 900 plafon / ceiling lamp | Index | |
| E27 | 8x max 23W, 230V, 50Hz | 1175P9A |
| LED ECO | 135W, 13095lm, 3000K / 4000K | 1175P9N1 |
| 900x900x110 | | |
| Geo 1000 plafon / ceiling lamp | Index | |
| E27 | 12x max 23W, 230V, 50Hz | 1175P10A |
| LED ECO | 135W, 13095lm, 3000K / 4000K | 1175P10N1 |
| 1000x1000x110 | | |



| | | | |
|--|------------------------------|------------------|--|
| Geo 340 wisząca / hanging lamp | | Index | |
| | 2x max 23W, 230V, 50Hz | 1175W3B | |
| | 1x 22W, 230V, 50Hz | 1775W3C | |
| | 19W, 2066lm, 3000K / 4000K | 1775W3L1 | |
| Geo 400 wisząca / hanging lamp | | Index | |
| | 4x max 23W, 230V, 50Hz | 1771 | |
| | 1x 22W, 230V, 50Hz | 1771W4C | |
| | 25W, 2755lm, 3000K / 4000K | 1771W4L2 | |
| Geo 500 wisząca / hanging lamp | | Index | |
| | 4x max 23W, 230V, 50Hz | 1770 | |
| | 1x 40W, 230V, 50Hz | 1770W5C | |
| | 25W, 2755lm, 3000K / 4000K | 1770W5L2 | |
| Geo 600 wisząca / hanging lamp | | Index | |
| | 4x max 23W, 230V, 50Hz | 1175W6A | |
| | 1x 40W, 230V, 50Hz | 1175W6B | |
| | 32W, 3444lm, 3000K / 4000K | 1775W6L3 | |
| Geo 700 wisząca / hanging lamp | | Index | |
| | 8x max 23W, 230V, 50Hz | 1175W7B | |
| | 32W, 3444lm, 3000K / 4000K | 1775W7L3 | |
| | 54W, 5238lm, 3000K / 4000K | 1775W7L4 | |
| Geo 800 wisząca / hanging lamp | | Index | |
| | 8x max 23W, 230V, 50Hz | 1175W8B | |
| | 72W, 6984lm, 3000K / 4000K | 1175W8L8 | |
| | 108W, 10476lm, 3000K / 4000K | 1175W8D4 | |
| Geo 900 wisząca / hanging lamp | | Index | |
| | 8x max 23W, 230V, 50Hz | 1175W9A | |
| | 135W, 13095lm, 3000K / 4000K | 1175W9N1 | |
| Geo 1000 wisząca / hanging lamp | | Index | |
| | 12x max 23W, 230V, 50Hz | 1175W10A | |
| | 135W, 13095lm, 3000K / 4000K | 1175W10N1 | |

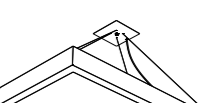

| | | | |
|---|------------------------------|------------------|---|
| Geo 600/300 prostokątne, plafon / rectangle, ceiling lamp | | Index | ±2% ⊕ IP20 F G |
|  E27 | 2x max 23W, 230V, 50Hz | 1175P63B |  |
|  2G11 | 2x 36W, 230V, 50Hz | 1175P63A | |
|  LED ECO | 36W, 3492lm, 3000K / 4000K | 1175P63D1 | |
| Geo 800/300 prostokątne, plafon / rectangle, ceiling lamp | | Index | ±2% ⊕ IP20 F G |
|  G5 | 2x 14W, 230V, 50Hz | 1175P83C |  |
|  G5 | 2x 24W, 230V, 50Hz | 1175P83D | |
|  LED ECO | 54W, 5238lm, 3000K / 4000K | 1175P83L4 | |
| Geo 800/400 prostokątne, plafon / rectangle, ceiling lamp | | Index | ±2% ⊕ IP20 F G |
|  E27 | 4x max 23W, 230V, 50Hz | 1175P84D |  |
|  G5 | 3x 24W, 230V, 50Hz | 1175P84C | |
|  LED ECO | 54W, 5238lm, 3000K / 4000K | 1175P84L4 | |
| Geo 1000/500 prostokątne, plafon / rectangle, ceiling lamp | | Index | ±2% ⊕ IP20 F G |
|  E27 | 5x max 23W, 230V, 50Hz | 1175P15C |  |
|  G5 | 4x 21W, 230V, 50Hz | 1175P15D | |
|  LED ECO | 135W, 13095lm, 3000K / 4000K | 1175P15N1 | |
| Geo 600/300 prostokątna, wisząca / rectangle hanging lamp | | Index | ±2% ⊕ IP20 F G |
|  E27 | 2x max 23W, 230V, 50Hz | 1175W63B |  |
|  LED ECO | 36W, 3492lm, 3000K / 4000K | 1175W63D1 | |
| Geo 800/300 prostokątna, wisząca / rectangle hanging lamp | | Index | ±2% ⊕ IP20 F G |
|  G5 | 2 x 24W, 230V, 50Hz | 1175W83D |  |
|  LED ECO | 54W, 5238lm, 3000K / 4000K | 1175W83L4 | |
| Geo 800/400 prostokątna, wisząca / rectangle hanging lamp | | Index | ±2% ⊕ IP20 F G |
|  E27 | 4x max 23W, 230V, 50Hz | 1175W84D |  |
|  LED ECO | 54W, 5238lm, 3000K / 4000K | 1175W84L4 | |
| Geo 1000/500 prostokątna, wisząca / rectangle hanging lamp | | Index | ±2% ⊕ IP20 F G |
|  E27 | 5x max 23W, 230V, 50Hz | 1175W15C |  |
|  LED ECO | 135W, 13095lm, 3000K / 4000K | 1175W15N1 | |



Plafony szkło proste / ceiling plain glass



Plafon 40 / Ceiling 40

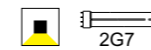

2x 11W, 230V, 50Hz
electronic ballast

Index

3780EL

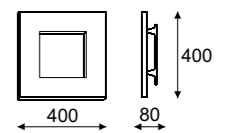

Plafon 50 / Ceiling 50

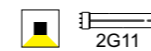

2x 24W, 230V, 50Hz
electronic ballast

Index

3781EL

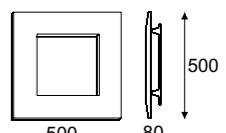

Plafon 60 / Ceiling 60



3x 36W, 230V, 50Hz
electronic ballast

Index

3782EL

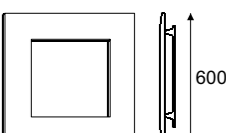

Plafon 70 / Ceiling 70

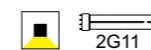

3x 36W, 230V, 50Hz
electronic ballast

Index

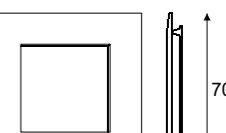

3783EL



Korytko wysokie pełne / high and full



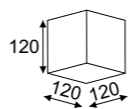
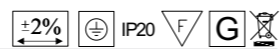

Korytko 12 kinkiet / wall lamp

| | | Index |
|--|----------------------------|---------------|
|  E27 | 1x max 40W, 230V, 50Hz | 6610 |
|  G9 | 1x max 40W, 230V, 50Hz | 6611 |
|  LED ECO | 4,5W, 437lm, 3000K / 4000K | 6610N2 |



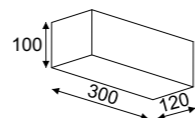

Korytko 30 kinkiet / wall lamp

| | | Index |
|--|--------------------------|---------------|
|  E27 | 1x max 23W, 230V, 50Hz | 6620 |
|  LED ECO | 9W, 873lm, 3000K / 4000K | 6620L5 |



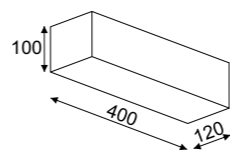

Korytko 40 kinkiet / wall lamp

| | | Index |
|--|--------------------------|---------------|
|  E27 | 1x max 23W, 230V, 50Hz | 6650 |
|  LED ECO | 9W, 873lm, 3000K / 4000K | 6650L5 |



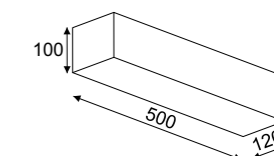

Korytko 50 kinkiet / wall lamp

| | | Index |
|---|----------------------------|---------------|
|  E27 | 2x max 23W, 230V, 50Hz | 6630 |
|  LED ECO | 9W, 873lm, 3000°K / 4000°K | 6630L5 |



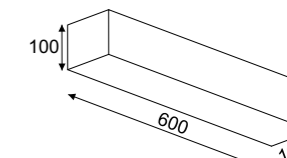
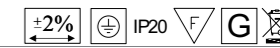

Korytko 60 kinkiet / wall lamp

| | | Index |
|---|------------------------------|---------------|
|  E27 | 2x max 23W, 230V, 50Hz | 6660 |
|  LED ECO | 18W, 1746lm, 3000°K / 4000°K | 6660L6 |



Korytko 70 kinkiet / wall lamp

| | | Index |
|---|------------------------------|---------------|
|  E27 | 2x max 23W, 230V, 50Hz | 6640 |
|  LED ECO | 18W, 1746lm, 3000°K / 4000°K | 6640L6 |

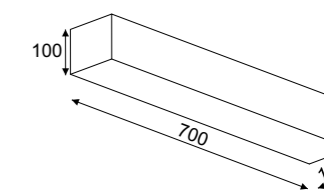
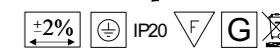

Korytko

Wysokie z dolnym szkłem
High and bottom glass



Korytko 12 kinkiet / wall lamp

Index



E27 1x max 40W, 230V, 50Hz **6810**

G9 1x max 40W, 230V, 50Hz **6811**

LED ECOV 9W, 873lm, 3000K / 4000K **6810K7**

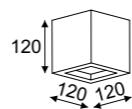

Korytko 30 kinkiet / wall lamp

Index



E27 1x max 23W, 230V, 50Hz **6820**

LED ECOV 9W, 873lm, 3000K / 4000K **6820L5**

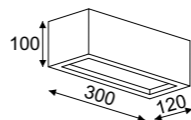

Korytko 40 kinkiet / wall lamp

Index



E27 1x max 23W, 230V, 50Hz **6850A**

LED ECOV 9W, 873lm, 3000K / 4000K **6850AL5**

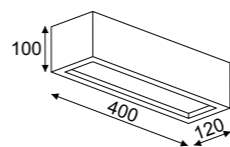

Korytko 50 kinkiet / wall lamp

Index



E27 2x max 23W, 230V, 50Hz **6830**

LED ECOV 9W, 873lm, 3000K / 4000K **6830L5**

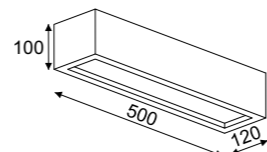

Korytko 60 kinkiet / wall lamp

Index

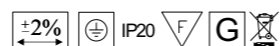

E27 2x max 23W, 230V, 50Hz **6860**

LED ECOV 18W, 1746lm, 3000K / 4000K **6860L6**

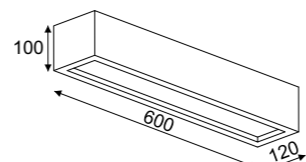

Korytko 70 kinkiet / wall lamp

Index



E27 2x max 23W, 230V, 50Hz **6840**

LED ECOV 18W, 1746lm, 3000K / 4000K **6840L6**

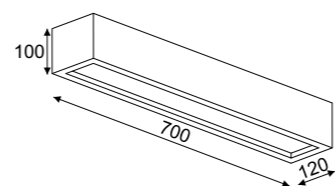

Korytko

Wysokie z dolnym i górnym szkłem
High with bottom and upper glass



Korytko 30 kinkiet / wall lamp

Index

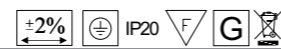

1x max 23W, 230V, 50Hz

6820/S



9W, 873lm, 3000K / 4000K

6820L5/S

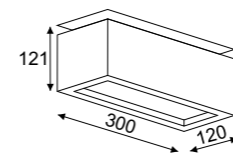

Korytko 40 kinkiet / wall lamp

Index



1x max 23W, 230V, 50Hz

6850/S



9W, 873lm, 3000K / 4000K

6850L5/S

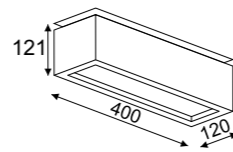

Korytko 50 kinkiet / wall lamp

Index



2x max 23W, 230V, 50Hz

6830/S



9W, 873lm, 3000K / 4000K

6830L5/S

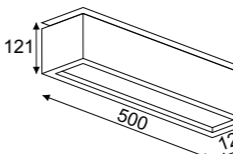

Korytko 60 kinkiet / wall lamp

Index



2x max 23W, 230V, 50Hz

6860/S



18W, 1746lm, 3000K / 4000K

6860L6/S

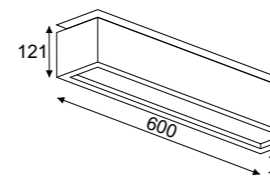

Korytko niskie pełne / low and full



| Korytko 12 kinkiet / wall lamp | | Index | |
|--------------------------------|----------------------------|--------|--|
| | 1x max 40W, 230V, 50Hz | 6670 | |
| | 4,5W, 437lm, 3000K / 4000K | 6670N2 | |
| Korytko 30 kinkiet / wall lamp | | Index | |
| | 1x max 23W, 230V, 50Hz | 6671 | |
| | 9W, 873lm, 3000K / 4000K | 6671L5 | |
| Korytko 40 kinkiet / wall lamp | | Index | |
| | 1x max 23W, 230V, 50Hz | 6672 | |
| | 9W, 873lm, 3000K / 4000K | 6672L5 | |
| Korytko 50 kinkiet / wall lamp | | Index | |
| | 2x max 23W, 230V, 50Hz | 6673 | |
| | 9W, 873lm, 3000K / 4000K | 6673L5 | |
| Korytko 60 kinkiet / wall lamp | | Index | |
| | 2x max 23W, 230V, 50Hz | 6674 | |
| | 18W, 1746lm, 3000K / 4000K | 6674L6 | |
| Korytko 70 kinkiet / wall lamp | | Index | |
| | 2x max 23W, 230V, 50Hz | 6675 | |
| | 18W, 1746lm, 3000K / 4000K | 6675L6 | |

Korytko

Niskie z dolnym szkłem
Low with bottom glass



| Korytko 12 kinkiet / wall lamp | | Index | |
|--------------------------------|----------------------------|--------|--|
| | 1x max 40W, 230V, 50Hz | 6870 | |
| | 9W, 873lm, 3000K / 4000K | 6870K7 | |
| Korytko 30 kinkiet / wall lamp | | Index | |
| | 1x max 23W, 230V, 50Hz | 6871 | |
| | 9W, 873lm, 3000K / 4000K | 6871L5 | |
| Korytko 40 kinkiet / wall lamp | | Index | |
| | 1x max 23W, 230V, 50Hz | 6872 | |
| | 9W, 873lm, 3000K / 4000K | 6872L5 | |
| Korytko 50 kinkiet / wall lamp | | Index | |
| | 2x max 23W, 230V, 50Hz | 6873 | |
| | 9W, 873lm, 3000K / 4000K | 6873L5 | |
| Korytko 60 kinkiet / wall lamp | | Index | |
| | 2x max 23W, 230V, 50Hz | 6874 | |
| | 18W, 1746lm, 3000K / 4000K | 6874L6 | |
| Korytko 70 kinkiet / wall lamp | | Index | |
| | 2x max 23W, 230V, 50Hz | 6875 | |
| | 18W, 1746lm, 3000K / 4000K | 6875L6 | |

Korytko

Niskie z dolnym i górnym szkłem
Low with bottom and upper glass



Korytko 30 kinkiet / wall lamp

Index



1x max 23W, 230V, 50Hz

6871/S



9W, 873lm, 3000K / 4000K

6871L5/S

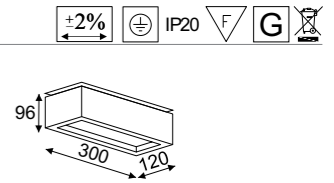

Korytko 40 kinkiet / wall lamp

Index



1x max 23W, 230V, 50Hz

6872/S



9W, 873lm, 3000K / 4000K

6872L5/S

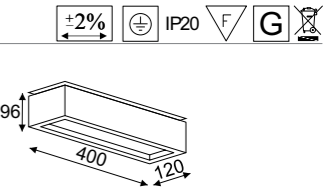

Korytko 50 kinkiet / wall lamp

Index



2x max 23W, 230V, 50Hz

6873/S



18W, 1746lm, 3000K / 4000K

6873L6/S

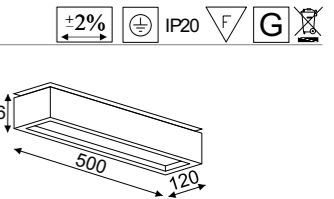

Korytko 60 kinkiet / wall lamp

Index



2x max 23W, 230V, 50Hz

6874/S



18W, 1746lm, 3000K / 4000K

6874L6/S

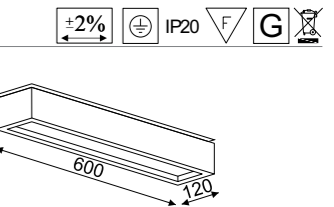

Korytko 70 kinkiet / wall lamp

Index



2x max 23W, 230V, 50Hz

6875/S



18W, 1746lm, 3000K / 4000K

6875L6/S

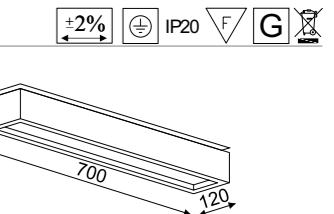

Korytka pionowe/ vertical



Dostępne w wersjach LED
www.cleoni.pl

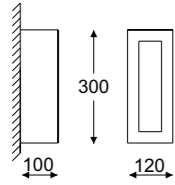

1x max 23W
7644

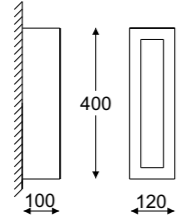

1x max 23W
7643

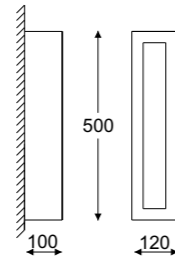

2x max 23W
7642

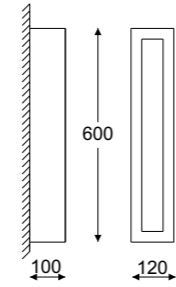

2x max 23W
7641

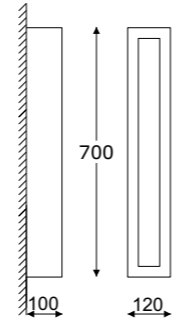

2x max 23W
7640



Korytka pionowe/ vertical

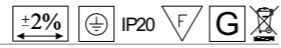

Dostępne w wersjach LED
www.cleoni.pl

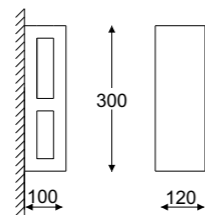

1x max 23W
7542

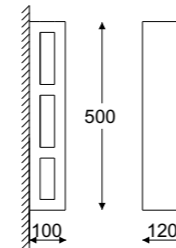

2x max 23W
7541

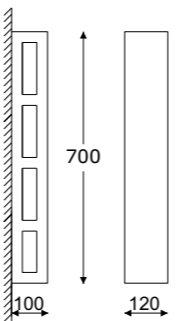

2x max 23W
7540



Belka pionowa/ vertical

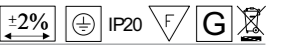

Dostępne w wersjach LED
www.cleoni.pl

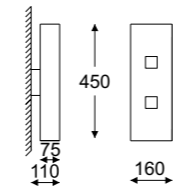

2x max 23W
7560

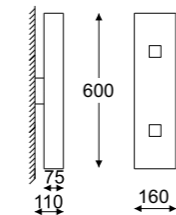

2x max 23W
7561

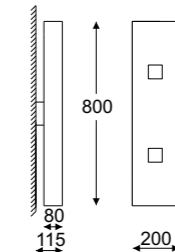

2x max 23W
7562

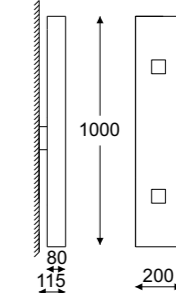

2x max 23W
7563

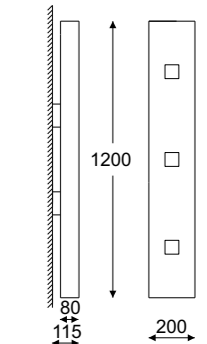

4x max 23W
7564

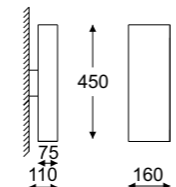

2x max 23W
7550

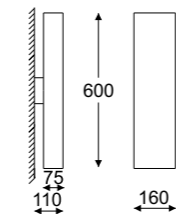

2x max 23W
7551

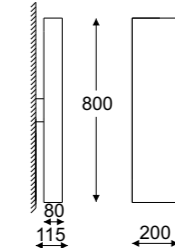

2x max 23W
7552

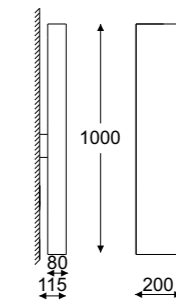

2x max 23W
7553

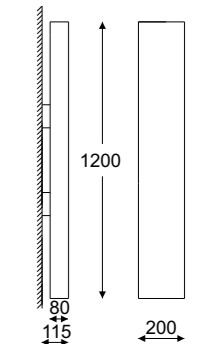

4x max 23W
7554



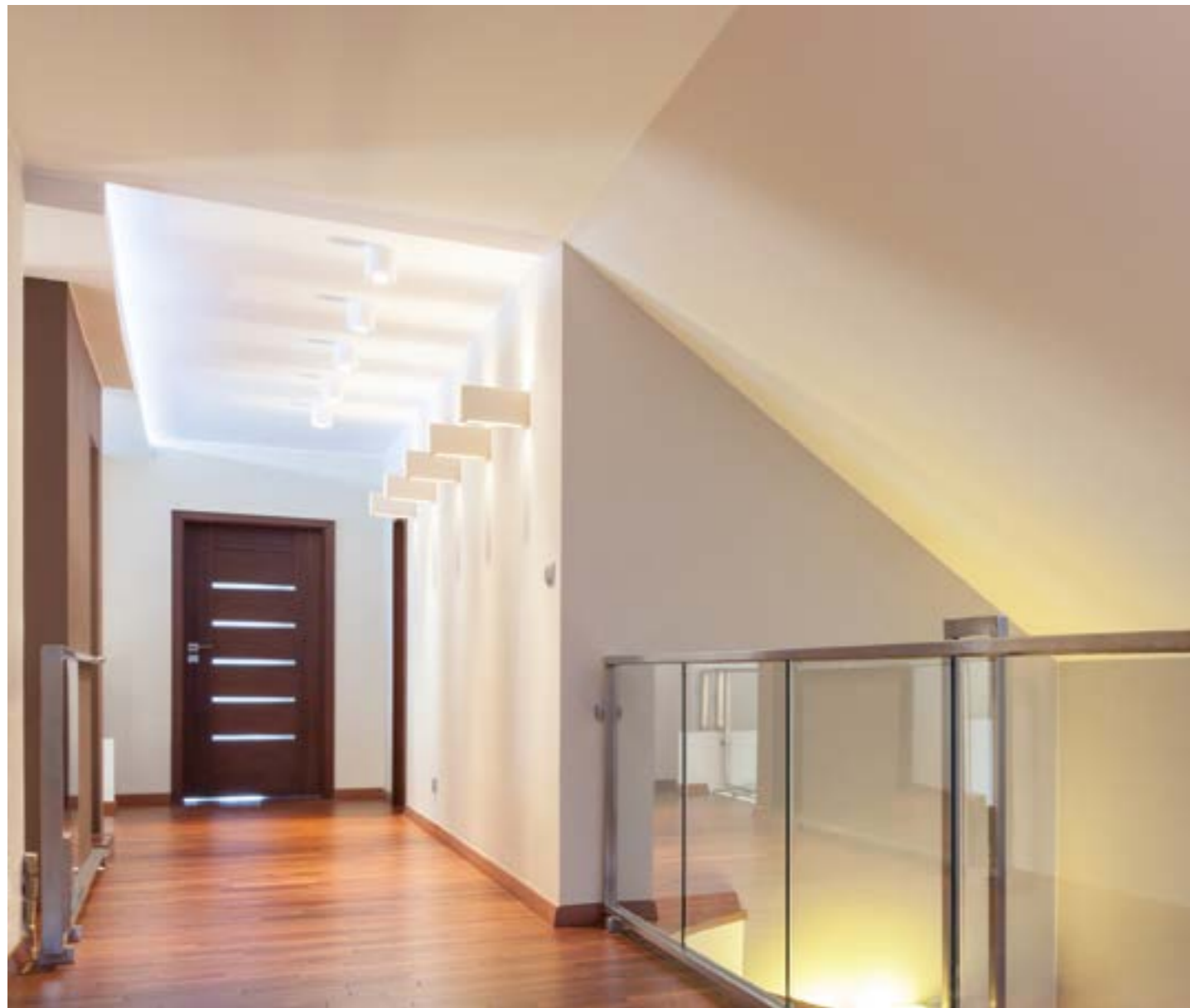

Korytko **Index** ±2% ⊕ IP20 F G

Niskie 24 / low 24

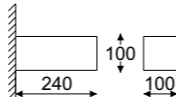
 1x max 18W **7312** 

Wysokie 24 / high 24

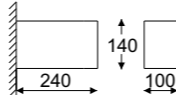
 1x max 18W **7310** 

Niskie 20 / low 20

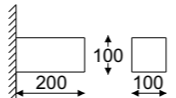
 1x max 11W **7313** 

Wysokie 20 / high 20

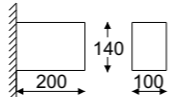
 1x max 11W **7311** 



Trójkąt ścienny / wall lamp

 1x max 23W, 230V, 50Hz **Index** ±2% ⊕ IP20 F G **1805** 

Trójkąt narożnikowy / corner

 1x max 23W, 230V, 50Hz **Index** ±2% ⊕ IP20 F G **1800** 

Wera prostokątna / rectangular

 1x max 23W, 230V, 50Hz **Index** ±2% ⊕ IP20 F G **1631** 

Wera kwadratowa / square

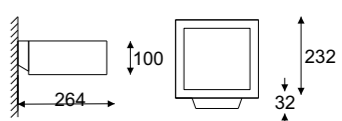
 1x max 23W, 230V, 50Hz **Index** ±2% ⊕ IP20 F G **1630** 

Wera trójkąt / triangle

 1x max 23W, 230V, 50Hz **Index** ±2% ⊕ IP20 F G **1632** 

Grove Ale kinkiet / wall lamp

Index

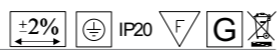

1x max 23W, 230V, 50Hz

1195ALE

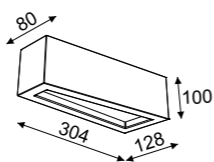

Alto A kinkiet / wall lamp

Index



1x max 23W, 230V, 50Hz

1169A

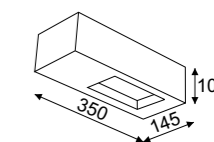

Grove Ape kinkiet / wall lamp

Index



1x max 23W, 230V, 50Hz

1195APE

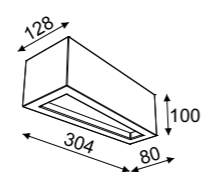

Alto B kinkiet / wall lamp

Index



1x max 23W, 230V, 50Hz

1169B

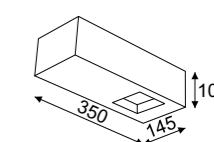

Grove Ble kinkiet / wall lamp

Index

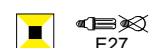

1x max 23W, 230V, 50Hz

1195BLE

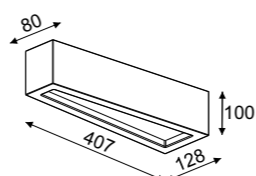

Alto C kinkiet / wall lamp

Index



1x max 23W, 230V, 50Hz

1169C

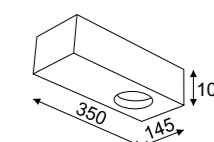

Grove Bpe kinkiet / wall lamp

Index

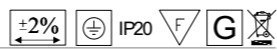

1x max 23W, 230V, 50Hz

1195BPE

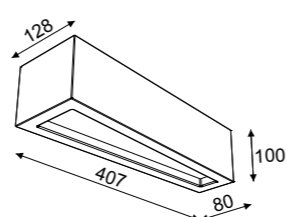

Alto D kinkiet / wall lamp

Index



1x max 23W, 230V, 50Hz

1169D

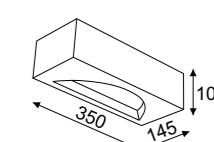

Grove Cle kinkiet / wall lamp

Index

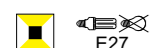

1x max 23W, 230V, 50Hz

1195CLE

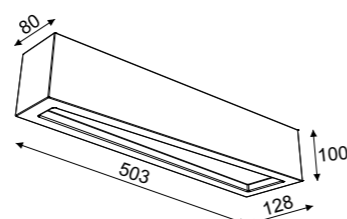

Alto E kinkiet / wall lamp

Index



1x max 23W, 230V, 50Hz

1169E

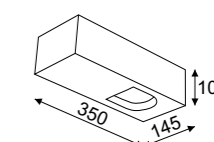

Grove Cpe kinkiet / wall lamp

Index

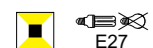

1x max 23W, 230V, 50Hz

1195CPE

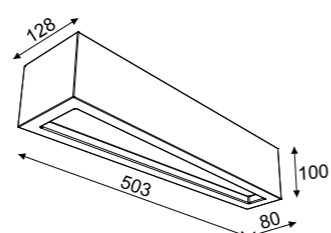

Nocava



Nocava A kinkiet / wall lamp



1x max 23W, 230V, 50Hz

Index

1109A

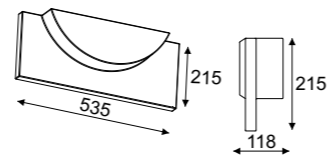

Nocava B kinkiet / wall lamp



1x max 23W, 230V, 50Hz

Index

1109B

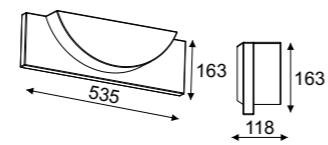

Nocava C kinkiet / wall lamp



1x max 23W, 230V, 50Hz

Index

1109C

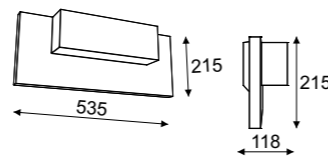

Nocava D kinkiet / wall lamp



1x max 23W, 230V, 50Hz

Index

1109D

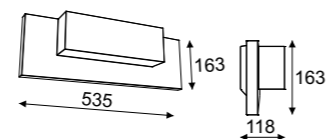

Clark



Clark Ape kinkiet / wall lamp



1x max 23W, 230V, 50Hz

Index

1197APE

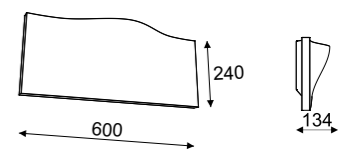

Clark Bpe kinkiet / wall lamp



1x max 23W, 230V, 50Hz

Index

1197BPE

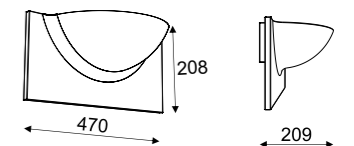

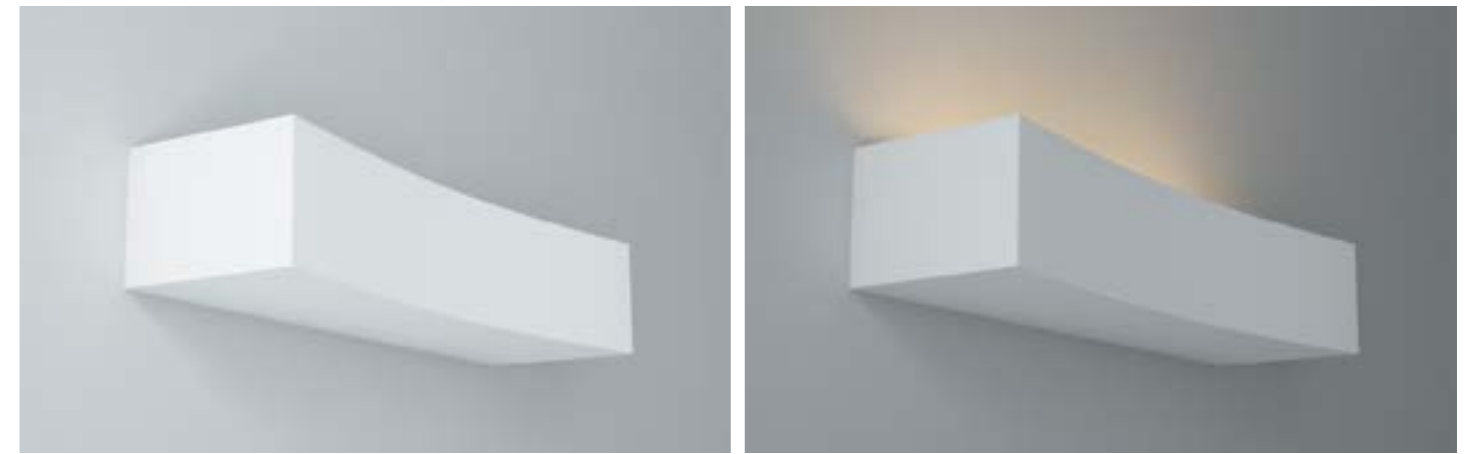

Korytko 50 wklęsłe pełne / concave full

Index

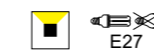
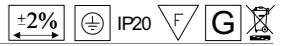

2x max 23W, 230V, 50Hz

7730



9W, 873lm, 3000K / 4000K

7730L5

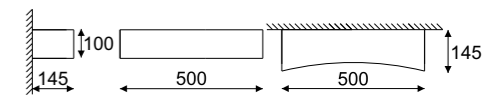

Korytko 40 wklęsłe pełne / concave full

Index

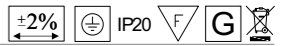

1x max 23W, 230V, 50Hz

7732



9W, 873lm, 3000K / 4000K

7732L5

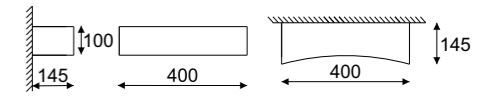

Rynna 14

Index

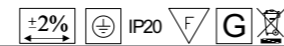

1x max 40W

6710



1x max 40W

6711

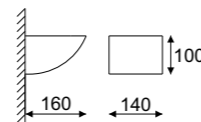

Rynna 30



1x max 23W

6720



9W, 873lm, 3000K / 4000K

6720L5

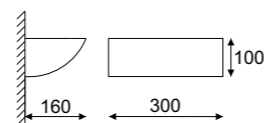

Rynna 50



2x max 23W

6730



9W, 873lm, 3000K / 4000K

6730L5

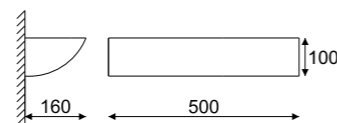

Rynna 70



2x max 23W

6740



18W, 1746lm, 3000K / 4000K

6740L6

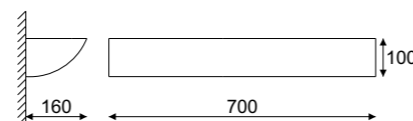

Rynna 90



4x max 23W

6750



27W, 2619lm, 3000K / 4000K

6750L7

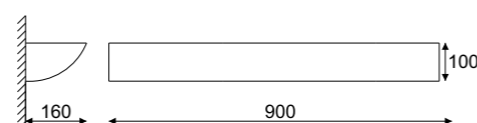

Korytko 50 wklęsłe ze szkłem / concave with glass

Index



2x max 23W, 230V, 50Hz

7731



9W, 873lm, 3000K / 4000K

7731L5

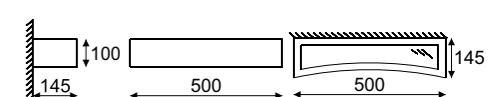

Korytko 40 wklęsłe ze szkłem / concave with glass

Index



1x max 23W, 230V, 50Hz

7733



9W, 873lm, 3000K / 4000K

7733L5

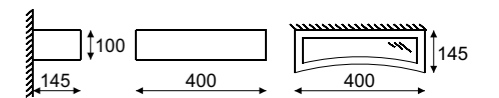

Korytko 12

Zaokrąglone wysokie
Rounded high



Korytko 12 zaokrąglone wysokie pełne / Rounded high and full

| | | Index |
|--|----------------------------|--------|
| | 1x max 40W, 230V, 50Hz | 7700 |
| | 1x max 40W, 230V, 50Hz | 7699 |
| | 4,5W, 437lm, 3000K / 4000K | 7700N2 |

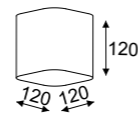
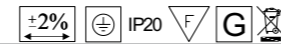

Korytko 12 zaokrąglone wysokie z dolnym szkłem / rounded high with bottom glass

| | | Index |
|--|--------------------------|--------|
| | 1x max 40W, 230V, 50Hz | 7707 |
| | 1x max 40W, 230V, 50Hz | 7706 |
| | 9W, 873lm, 3000K / 4000K | 7707K7 |

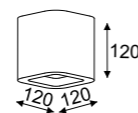

Korytko

Zaokrąglone wysokie z dolnym szkłem
Rounded high with bottom glass

Korytko 30 kinkiet / wall lamp

| | | Index |
|--|--|-------|
| | 1x max 23W, 230V, 50Hz | 7708 |
| | 1x 18W, 230V, 50Hz electronic ballast | 6626 |

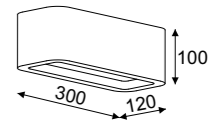
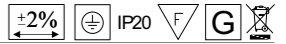

Korytko 40 kinkiet / wall lamp

| | | Index |
|--|--|--------|
| | 1x max 23W, 230V, 50Hz | 7709 |
| | 1x 24W, 230V, 50Hz electronic ballast | 6656 |
| | 9W, 873lm, 3000K / 4000K | 7709L5 |

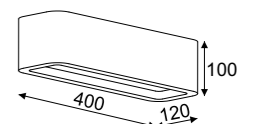

Korytko 50 kinkiet / wall lamp

| | | Index |
|--|--|--------|
| | 2x max 23W, 230V, 50Hz | 7710 |
| | 1x 36W, 230V, 50Hz electronic ballast | 6636 |
| | 9W, 873lm, 3000K / 4000K | 7710L5 |

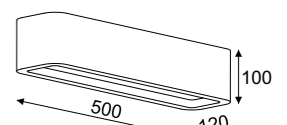

Korytko 60 kinkiet / wall lamp

| | | Index |
|--|----------------------------|--------|
| | 2x max 23W, 230V, 50Hz | 7711 |
| | 18W, 1746lm, 3000K / 4000K | 7711L6 |

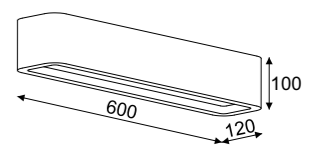
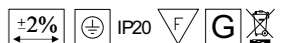

Korytko 70 kinkiet / wall lamp

| | | Index |
|--|----------------------------|--------|
| | 2x max 23W, 230V, 50Hz | 7712 |
| | 18W, 1746lm, 3000K / 4000K | 7712L6 |

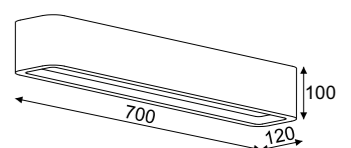
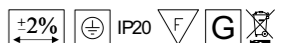

Korytko

Zaokrąglone wysokie z dolnym i górnym szkłem
Rounded and high with bottom and upper glass

Korytko 30 kinkiet / wall lamp

Index

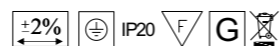

1x max 23W, 230V, 50Hz

7708/s



9W, 873lm, 3000K / 4000K

7708L5/s

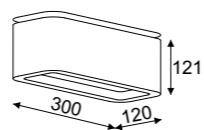

Korytko 40 kinkiet / wall lamp

Index

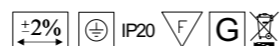

1x max 23W, 230V, 50Hz

7709/s



9W, 873lm, 3000K / 4000K

7709L5/s

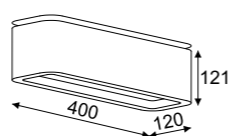

Korytko 50 kinkiet / wall lamp

Index



2x max 23W, 230V, 50Hz

7710/s



9W, 1746lm, 3000K / 4000K

7710L5/s

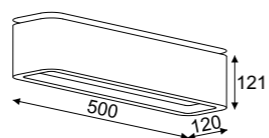

Korytko 60 kinkiet / wall lamp

Index



2x max 23W, 230V, 50Hz

7711/s



18W, 1746lm, 3000K / 4000K

7711L6/s

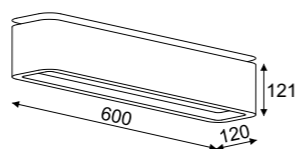

Korytko

Zaokrąglone niskie pełne
Rounded low and full



Korytko 12 kinkiet / wall lamp

Index



| | | |
|--|----------------------------|---------------|
| | 1x max 40W, 230V, 50Hz | 7713 |
| | 4,5W, 437lm, 3000K / 4000K | 7713N2 |

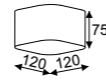

Korytko 30 kinkiet / wall lamp

Index



| | | |
|--|--------------------------|---------------|
| | 1x max 23W, 230V, 50Hz | 7714 |
| | 9W, 873lm, 3000K / 4000K | 7714L5 |

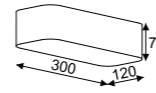

Korytko 40 kinkiet / wall lamp

Index



| | | |
|--|--------------------------|---------------|
| | 1x max 23W, 230V, 50Hz | 7715 |
| | 9W, 873lm, 3000K / 4000K | 7715L5 |

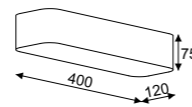

Korytko 50 kinkiet / wall lamp

Index



| | | |
|--|--------------------------|---------------|
| | 2x max 23W, 230V, 50Hz | 7716 |
| | 9W, 873lm, 3000K / 4000K | 7716L5 |

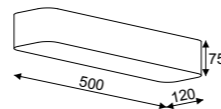

Korytko 60 kinkiet / wall lamp

Index



| | | |
|--|----------------------------|---------------|
| | 2x max 23W, 230V, 50Hz | 7717 |
| | 18W, 1746lm, 3000K / 4000K | 7717L6 |

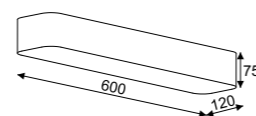

Korytko 70 kinkiet / wall lamp

Index



| | | |
|--|----------------------------|---------------|
| | 2x max 23W, 230V, 50Hz | 7718 |
| | 18W, 1746lm, 3000K / 4000K | 7718L6 |

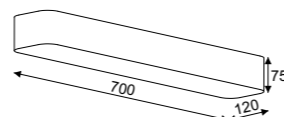

Korytko

Niskie z dolnym i górnym szkłem
Rounded and low with bottom and upper glass



Korytko 30 kinkiet / wall lamp

Index



| | | |
|--|--------------------------|-----------------|
| | 1x max 23W, 230V, 50Hz | 7720/s |
| | 9W, 873lm, 3000K / 4000K | 7720L5/s |

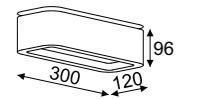

Korytko 40 kinkiet / wall lamp

Index

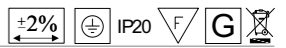

| | | |
|--|--------------------------|-----------------|
| | 1x max 23W, 230V, 50Hz | 7721/s |
| | 9W, 873lm, 3000K / 4000K | 7721L5/s |

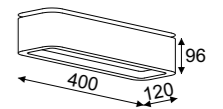

Korytko 50 kinkiet / wall lamp

Index



| | | |
|--|--------------------------|-----------------|
| | 2x max 23W, 230V, 50Hz | 7722/s |
| | 9W, 873lm, 3000K / 4000K | 7722L5/s |

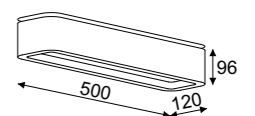

Korytko 60 kinkiet / wall lamp

Index

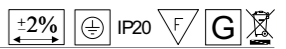

| | | |
|--|----------------------------|-----------------|
| | 2x max 23W, 230V, 50Hz | 7723/s |
| | 18W, 1746lm, 3000K / 4000K | 7723L6/s |

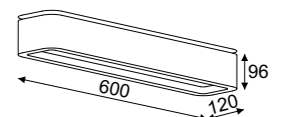

Korytko

Niskie z dolnym szkłem
Roundet low with bottom glass



Korytko 12 kinkiet / wall lamp

Index

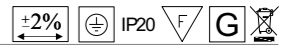

1x max 40W, 230V, 50Hz

7719



LED ECO

9W, 873lm, 3000K / 4000K

7719K7

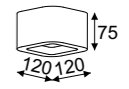

Korytko 30 kinkiet / wall lamp

Index

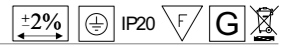

1x max 23W, 230V, 50Hz

7720



1x 18W, 230V, 50Hz
elektronik ballast

6628



LED ECO

9W, 873lm, 3000K / 4000K

7720L5

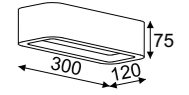

Korytko 40 kinkiet / wall lamp

Index

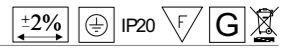

1x max 23W, 230V, 50Hz

7721



1x 24W, 230V, 50Hz
elektronik ballast

6658



LED ECO

9W, 873lm, 3000K / 4000K

7721L5

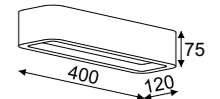

Korytko 50 kinkiet / wall lamp

Index

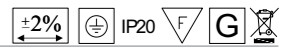

2x max 23W, 230V, 50Hz

7722



1x 36W, 230V, 50Hz
elektronik ballast

6638



LED ECO

9W, 873lm, 3000K / 4000K

7722L5



Korytko 60 kinkiet / wall lamp

Index

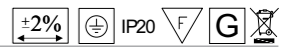

2x max 23W, 230V, 50Hz

7723



LED ECO

18W, 1746lm, 3000K / 4000K

7723L6

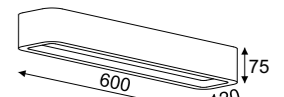

Korytko 70 kinkiet / wall lamp

Index

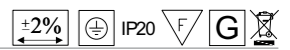

2x max 23W, 230V, 50Hz

7724



LED ECO

18W, 1746lm, 3000K / 4000K

7724L6

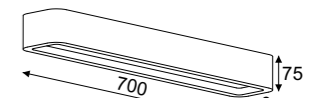

Omega



| Omega 380 plafon / ceiling lamp | | Index | ±2% | IP20 | F | G |
|---------------------------------|----------------------------|----------|-----|------|---|---|
| | 3 x max 23W, 230V, 50Hz | 1171P3A | | | | |
| | 19W, 2066lm, 3000K / 4000K | 1171P3L1 | | | | |

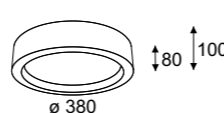

| Omega 440 plafon / ceiling lamp | | Index | ±2% | IP20 | F | G |
|---------------------------------|----------------------------|----------|-----|------|---|---|
| | 3 x max 23W, 230V, 50Hz | 1171P4A | | | | |
| | 1x 40W, 230V, 50Hz | 1171P4B | | | | |
| | 25W, 2755lm, 3000K / 4000K | 1171P4L2 | | | | |



| Omega 500 plafon / ceiling lamp | | Index | ±2% | IP20 | F | G |
|---------------------------------|----------------------------|----------|-----|------|---|---|
| | 3x max 23W, 230V, 50Hz | 1171P5A | | | | |
| | 1x 40W, 230V, 50Hz | 1171P5B | | | | |
| | 25W, 2755lm, 3000K / 4000K | 1171P5L2 | | | | |

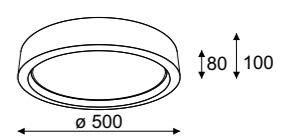

| Omega 600 plafon / ceiling lamp | | Index | ±2% | IP20 | F | G |
|---------------------------------|----------------------------|----------|-----|------|---|---|
| | 3x max 23W, 230V, 50Hz | 1171P6A | | | | |
| | 6x max 23W, 230V, 50Hz | 1171P6B | | | | |
| | 3x 22W, 230V, 50Hz | 1171P6C | | | | |
| | 75W, 8265lm, 3000K / 4000K | 1171P6D3 | | | | |

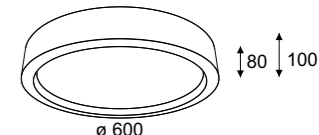

| Omega 700 plafon / ceiling lamp | | Index | ±2% | IP20 | F | G |
|---------------------------------|----------------------------|----------|-----|------|---|---|
| | 4x max 23W, 230V, 50Hz | 1171P7A | | | | |
| | 4x 22W, 230V, 50Hz | 1171P7C | | | | |
| | 75W, 8265lm, 3000K / 4000K | 1171P7D3 | | | | |

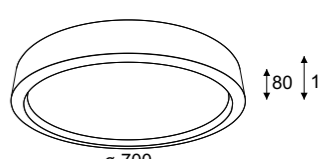

| Omega 800 plafon / ceiling lamp | | Index | ±2% | IP20 | F | G |
|---------------------------------|----------------------------|----------|-----|------|---|---|
| | 8x max 23W, 230V, 50Hz | 1171P8B | | | | |
| | 4x 22W, 230V, 50Hz | 1171P8C | | | | |
| | 81W, 7857lm, 3000K / 4000K | 1171P8D2 | | | | |

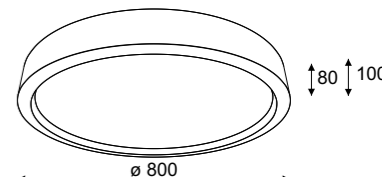

| Omega 900 plafon / ceiling lamp | | Index | ±2% | IP20 | F | G |
|---------------------------------|----------------------------|----------|-----|------|---|---|
| | 8x max 23W, 230V, 50Hz | 1171P9A | | | | |
| | 81W, 7857lm, 3000K / 4000K | 1171P9D2 | | | | |

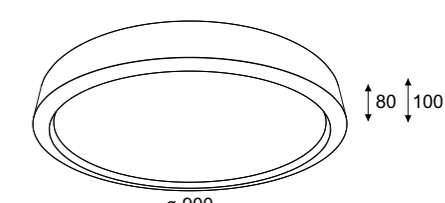

| Omega 1000 plafon / ceiling lamp | | Index | ±2% | IP20 | F | G |
|----------------------------------|------------------------------|-----------|-----|------|---|---|
| | 8 x max 23W, 230V, 50Hz | 1171P10A | | | | |
| | 117W, 11349lm, 3000K / 4000K | 1171P10D5 | | | | |

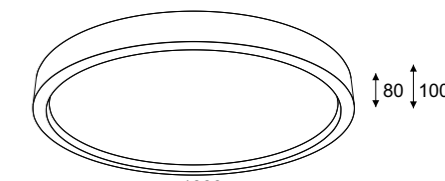

Omega



Omega 600 plafon / ceiling lamp

Index

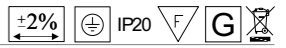

3x max 23W, 230V, 50Hz

1171W6A



6x max 23W, 230V, 50Hz

1171W6B



3x 22W, 230V, 50Hz

1171W6C



75W, 8265lm, 3000K / 4000K

1171W6D3

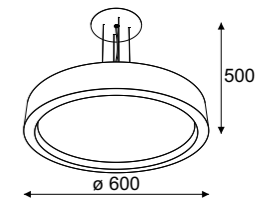

Omega 700 plafon / ceiling lamp

Index

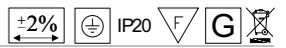

4x max 23W, 230V, 50Hz

1171W7A



4x 22W, 230V, 50Hz

1171W7C



75W, 8265lm, 3000K / 4000K

1171W7D3

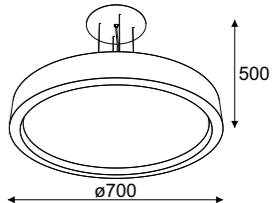

Omega 800 plafon / ceiling lamp

Index



4x max 23W, 230V, 50Hz

1171W8A



4 x 22W, 230V, 50Hz

1171W8C



81W, 7857lm, 3000K / 4000K

1171W8D2

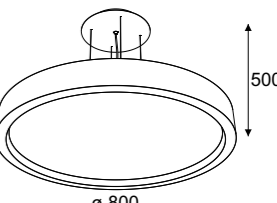

Omega 380 wisząca / hanging lamp

Index



3 x max 23W, 230V, 50Hz

1171W3A



19W, 2066lm, 3000K / 4000K

1171W3L1

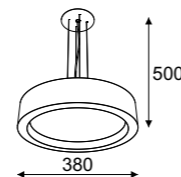

Omega 440 wisząca / hanging lamp

Index



3 x max 23W, 230V, 50Hz

1171W4A



25W, 2755lm, 3000K / 4000K

1171W4L2

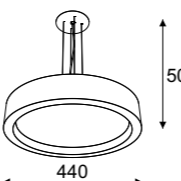

Omega 500 plafon / ceiling lamp

Index



3x max 23W, 230V, 50Hz

1171W5A



25W, 2755lm, 3000K / 4000K

1171W5L2

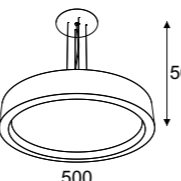

Omega 900 plafon / ceiling lamp

Index



8x max 23W, 230V, 50Hz

1171W9A



81W, 7857lm, 3000K / 4000K

1171W9D2

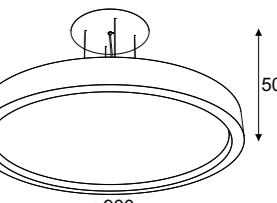

Omega 1000 plafon / ceiling lamp

Index



8 x max 23W, 230V, 50Hz

1171W10A



117W, 11349lm, 3000K / 4000K

1171W10D5

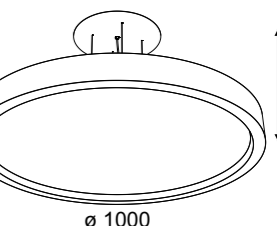



Omega 40 kinkiet / wall lamp



1x max 23W, 230V, 50Hz

Index



9W, 873lm, 3000K / 4000K

1380



Omega 50 kinkiet / wall lamp



2x max 23W, 230V, 50Hz

Index



18W, 1746lm, 3000K / 4000K

1440

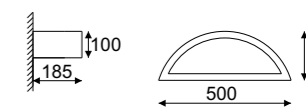

Omega 60 kinkiet / wall lamp



2x max 23W, 230V, 50Hz

Index



18W, 1746lm, 3000K / 4000K

1330

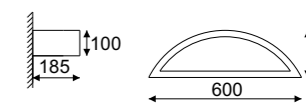

Omega 70 kinkiet / wall lamp



2x max 23W, 230V, 50Hz

Index



18W, 1746lm, 3000K / 4000K

1450

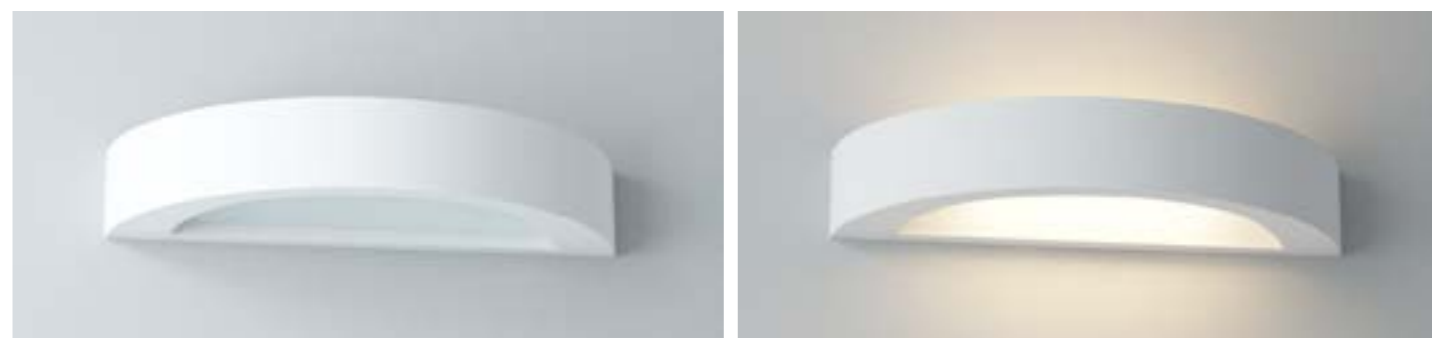
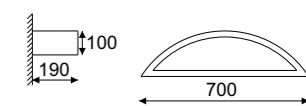

Omega N kinkiet / wall lamp



1x max 23W, 230V, 50Hz

Index



9W, 873lm, 3000K / 4000K

1106

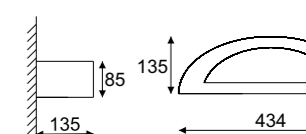



| | | |
|-------------------------------------|---------------|--|
| Omega 18 kinkiet / wall lamp | Index | |
| 1x max 40W, 230V, 50Hz | 1322 | |
| 9W, 873lm, 3000K / 4000K | 1322K7 | |
| Omega 25 kinkiet / wall lamp | Index | |
| 1x max 40W, 230V, 50Hz | 1321 | |
| 1x max 40W, 230V, 50Hz | 1320 | |
| 9W, 873lm, 3000K / 4000K | 1321K7 | |



| | | |
|--------------------------------------|--------------|--|
| Omega Due kinkiet / wall lamp | Index | |
| 2x max 23W, 230V, 50Hz | 1500 | |



| | | |
|---|---------------|--|
| Omega 50 bliźniak - lewy / light | Index | |
| 1x max 23W, 230V, 50Hz | 1480 | |
| 9W, 873lm, 3000K / 4000K | 1480L5 | |

| | | |
|--|---------------|--|
| Omega 50 bliźniak - prawy / right | Index | |
| 1x max 23W, 230V, 50Hz | 1490 | |
| 9W, 873lm, 3000K / 4000K | 1490L5 | |

| | | |
|--|---------------|--|
| Omega 65 bliźniak - lewy / left | Index | |
| 2x max 23W, 230V, 50Hz | 1460 | |
| 18W, 1746lm, 3000K / 4000K | 1460L6 | |

| | | |
|--|---------------|--|
| Omega 65 bliźniak - prawy / right | Index | |
| 2x max 23W, 230V, 50Hz | 1470 | |
| 18W, 1746lm, 3000K / 4000K | 1470L6 | |

Luna



| | | | |
|------------------------------------|----------------------------|---------------|--|
| Luna 25 kinkiet / wall lamp | | Index | |
| | 1x max 23W, 230V, 50Hz | 1620 | |
| | 9W, 873lm, 3000K / 4000K | 1620K7 | |
| Luna 34 kinkiet / wall lamp | | Index | |
| | 1x max 23W, 230V, 50Hz | 1621 | |
| | 9W, 873lm, 3000K / 4000K | 1621L5 | |
| Luna 45 kinkiet / wall lamp | | Index | |
| | 1x max 23W, 230V, 50Hz | 1622 | |
| | 9W, 873lm, 3000K / 4000K | 1622L5 | |
| Luna 57 kinkiet / wall lamp | | Index | |
| | 2x max 23W, 230V, 50Hz | 1623 | |
| | 18W, 1746lm, 3000K / 4000K | 1623K4 | |
| Luna 34 kinkiet / wall lamp | | Index | |
| | 1x max 23W, 230V, 50Hz | 1641 | |
| | 9W, 873lm, 3000K / 4000K | 1641L5 | |
| Luna 45 kinkiet / wall lamp | | Index | |
| | 1x max 23W, 230V, 50Hz | 1642 | |
| | 9W, 873lm, 3000K / 4000K | 1642L5 | |
| Luna 57 kinkiet / wall lamp | | Index | |
| | 2x max 23W, 230V, 50Hz | 1643 | |
| | 18W, 1746lm, 3000K / 4000K | 1643K4 | |
| Luna 68 kinkiet / wall lamp | | Index | |
| | 2x max 23W, 230V, 50Hz | 1644 | |
| | 18W, 1746lm, 3000K / 4000K | 1644L6 | |



Miseczka płaska prosta III / flat plain III

Index



| | | |
|--|--------------------------|---------------|
| | 1x max 23W, 230V, 50Hz | 1551 |
| | 9W, 873lm, 3000K / 4000K | 1551L5 |

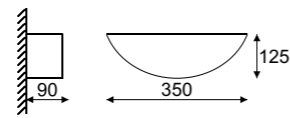

Miseczka płaska prosta IV / flat plain IV

Index

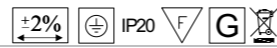

| | | |
|--|--------------------------|---------------|
| | 1 x max 23W, 230V, 50Hz | 1541 |
| | 9W, 873lm, 3000K / 4000K | 1541L5 |

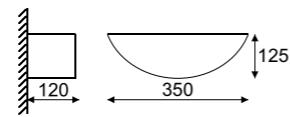

Misa VII kotyska prosta / plain

Index

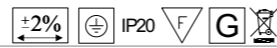

| | | |
|--|----------------------------|---------------|
| | 2x max 23W, 230V, 50Hz | 1554 |
| | 18W, 1746lm, 3000K / 4000K | 1554K4 |

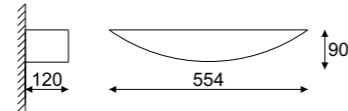

Misa VIII kotyska prosta / plain

Index



| | | |
|--|----------------------------|---------------|
| | 2x max 23W, 230V, 50Hz | 1555 |
| | 18W, 1746lm, 3000K / 4000K | 1555L6 |

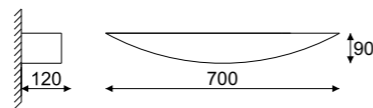

Lauro A kinkiet / wall lamp

Index

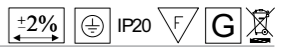

| | | |
|--|--------------------------|----------------|
| | 1x max 23W, 230V, 50Hz | 1117A |
| | 9W, 873lm, 3000K / 4000K | 1117AL5 |

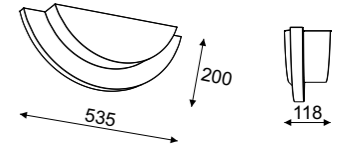

Lauro B kinkiet / wall lamp

Index



| | | |
|--|--------------------------|----------------|
| | 1x max 23W, 230V, 50Hz | 1117B |
| | 9W, 873lm, 3000K / 4000K | 1117BL5 |

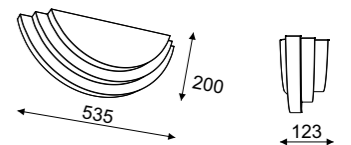



| | | |
|---|---------------|--|
| Łódka mała gładka / small smooth | Index | |
| 1x max 23W, 230V, 50Hz | 6330 | |
| 9W, 873lm, 3000K / 4000K | 6330L5 | |
| Łódka średnia gładka / medium smooth | Index | |
| 1x max 23W, 230V, 50Hz | 6230 | |
| 18W, 1746lm, 3000K / 4000K | 6230K4 | |
| Łódka duża gładka / large smooth | Index | |
| 2x max 23W, 230V, 50Hz | 6130 | |
| 36W, 3492lm, 3000K / 4000K | 6130D1 | |

| | | |
|---|---------------|--|
| Łódka klasyczna / classic | Index | |
| 1x max 23W, 230V, 50Hz | 6350 | |
| 18W, 1746lm, 3000K / 4000K | 6350L5 | |
| Łódka niska, gładka / low, smooth | Index | |
| 1x max 23W, 230V, 50Hz | 6360 | |
| 18W, 1746lm, 3000K / 4000K | 6360L5 | |
| Łódka mała fala / small, wave | Index | |
| 1x max 23W, 230V, 50Hz | 6320 | |
| 18W, 1746lm, 3000K / 4000K | 6320L5 | |
| Bliźniak mały lewy / small, left | Index | |
| 2x max 23W, 230V, 50Hz | 6450 | |
| 18W, 1746lm, 3000K / 4000K | 6450L6 | |
| Bliźniak mały prawy / small, right | Index | |
| 2x max 23W, 230V, 50Hz | 6440 | |
| 18W, 1746lm, 3000K / 4000K | 6440L6 | |
| Bliźniak lewy / left | Index | |
| 2x max 23W, 230V, 50Hz | 6430 | |
| 18W, 1746lm, 3000K / 4000K | 6430L6 | |
| Bliźniak prawy / right | Index | |
| 2x max 23W, 230V, 50Hz | 6420 | |
| 18W, 1746lm, 3000K / 4000K | 6420L6 | |
| | | |

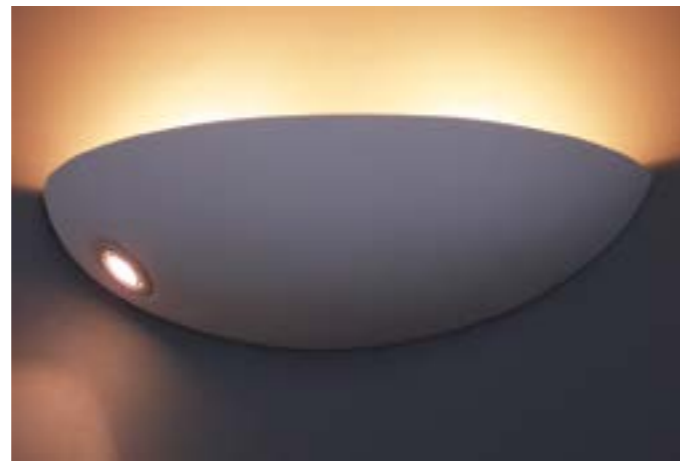

Łódka średnia, prawy halogen / medium, right halogen

1x E27 max 23W, 230V, 50Hz
1x Gu4 35W, 12V, 50Hz

Index

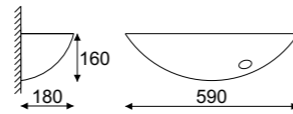

Łódka średnia, lewy halogen / medium, left halogen

1x E27 max 23W, 230V, 50Hz
1x Gu4 35W, 12V, 50Hz

Index

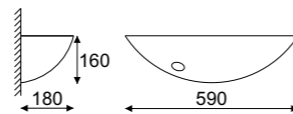

Łódka mała grecka / small, greek

1x max 23W, 230V, 50Hz

Index

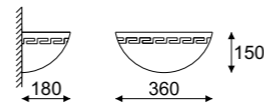

9W, 873lm, 3000K / 4000K

6310L5

Łódka średnia grecka / medium, greek

1x max 23W, 230V, 50Hz

Index

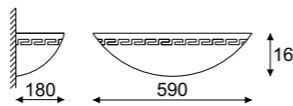

18W, 1746lm, 3000K / 4000K

6210K4

Łódka duża grecka / large, greek

2x max 23W, 230V, 50Hz

Index

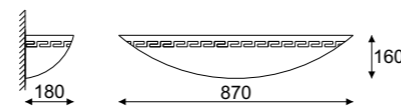

36W, 3492lm, 3000K / 4000K

6110D1

Jowisz głęboki/ deep



1x max 23W, 230V, 50Hz

Index

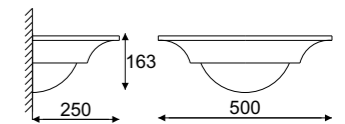
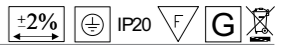

Jowisz płytki/ shallow



1x max 11W, 230V, 50Hz

Index

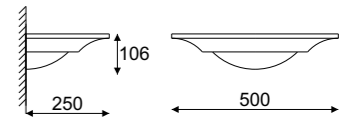

Elmarco - prążki narożnikowa / stripes corner



1x max 23W, 230V, 50Hz

Index

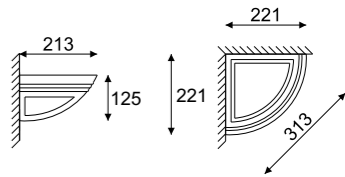

Elmarco prążki / stripes



1x max 23W, 230V, 50Hz

Index

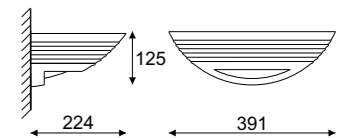

Elmarco - gładka narożnikowa / smooth corner



1x max 23W, 230V, 50Hz

Index

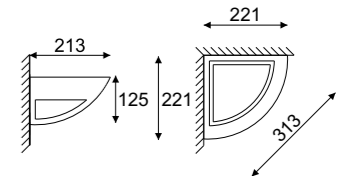

Elmarco - gładka / smooth



1x max 23W, 230V, 50Hz

Index

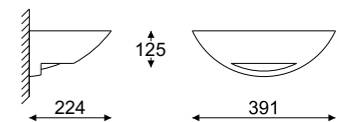

Belle Asg kinkiet / wall lamp

Index

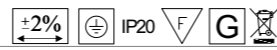

1x max 23W, 230V, 50Hz

1196ASG

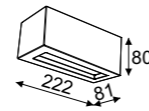

Belle Cng kinkiet / wall lamp

Index



2x max 23W, 230V, 50Hz

1196CNG

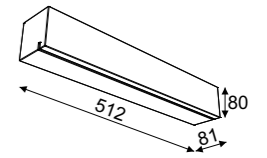

Belle BSG kinkiet / wall lamp

Index

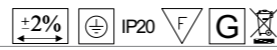

1x max 23W, 230V, 50Hz

1196BSG

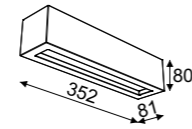

Belle Apg kinkiet / wall lamp

Index



1x max 23W, 230V, 50Hz

1196APG

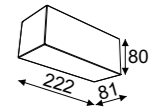

Belle CSG kinkiet / wall lamp

Index



2x max 23W, 230V, 50Hz

1196CSG

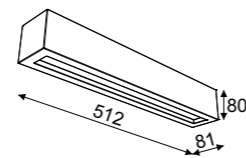

Belle Bpg kinkiet / wall lamp

Index



1x max 23W, 230V, 50Hz

1196BPG

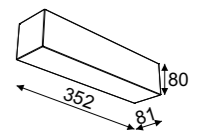

Belle Ang kinkiet / wall lamp

Index

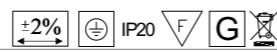

1x max 23W, 230V, 50Hz

1196ANG

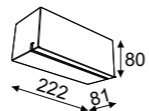

Belle Dse kinkiet / wall lamp

Index

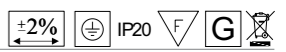

1x max 23W, 230V, 50Hz

1196DSE

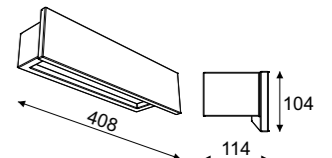

Belle Bng kinkiet / wall lamp

Index



1x max 23W, 230V, 50Hz

1196BNG

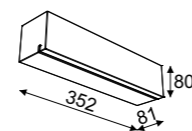

Belle Hse kinkiet / wall lamp

Index



1x max 23W, 230V, 50Hz

1196HSE

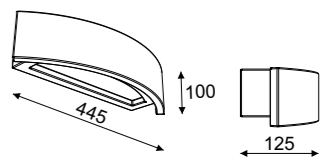



Linea ścienna / wall



2x max 23W, 230V, 50Hz

Index

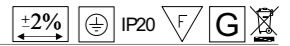

8480



36W, 3492lm, 3000K / 4000K

8480D1

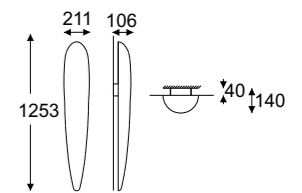

Linea narożnikowa / corner



2x max 23W, 230V, 50Hz

Index



8481



36W, 3492lm, 3000K / 4000K

8481D1

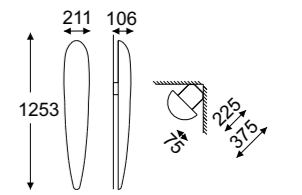

Linea cięta ścienna / cut wall



2x max 23W, 230V, 50Hz

Index



8450



36W, 3492lm, 3000K / 4000K

8450D1

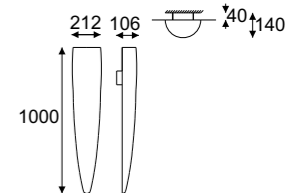

Linea narożnikowa / corner



2x max 23W, 230V, 50Hz

Index



8451



36W, 3492lm, 3000K / 4000K

8451D1

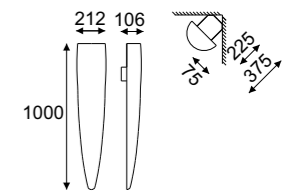

Linea krótka ścienna / short wall



1x max 23W, 230V, 50Hz

Index



8580



18W, 1746lm, 3000K / 4000K

8580K4

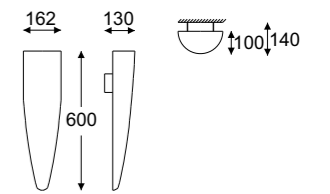

Linea krótka narożnikowa / short corner



1x max 23W, 230V, 50Hz

Index



8581



18W, 1746lm, 3000K / 4000K

8581K4

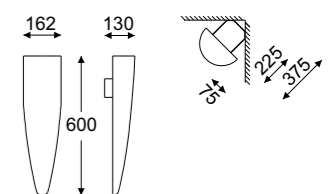

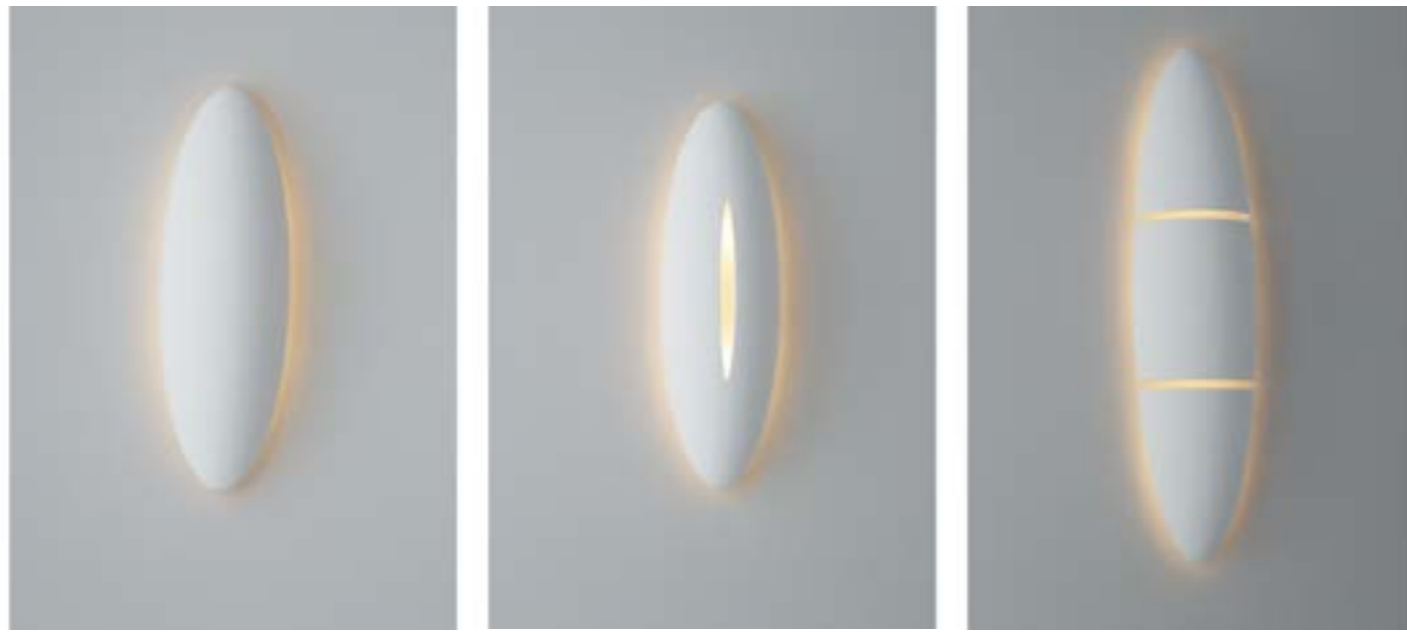

Zoe z szybą 90 ścienna / wall version

Index



2 x max 23W, 230V, 50Hz

8471



36W, 3492lm, 3000K / 4000K

8471D1

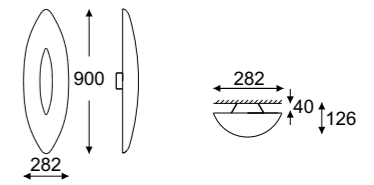

Zoe z szybą 90 narożnikowa / corner version

Index

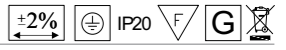

2 x max 23W, 230V, 50Hz

8511



36W, 3492lm, 3000K / 4000K

8511D1

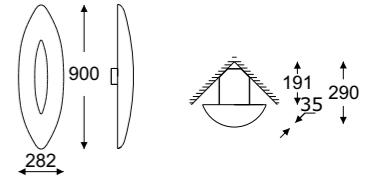

Zoe z szybą 120 ścienna / wall version

Index



2 x max 23W, 230V, 50Hz

8461



36W, 3492lm, 3000K / 4000K

8461D1

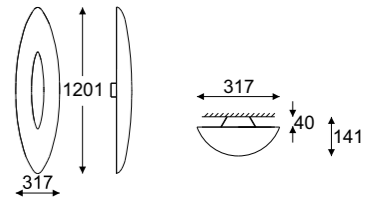

Zoe z szybą 120 narożnikowa / corner version

Index



2 x max 23W, 230V, 50Hz

8521



36W, 3492lm, 3000K / 4000K

8521D1

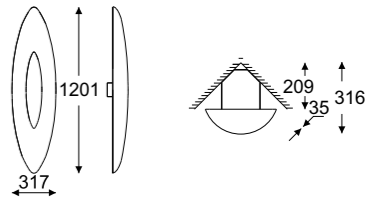

ZOE III ścienna / wall version

Index



4x max 23W, 230V, 50Hz

8500

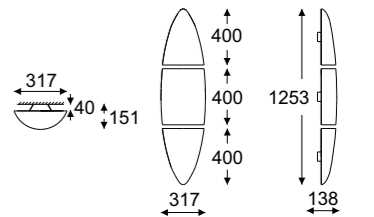

Zoe 90 ścienna / wall version

Index

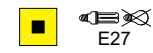

2x max 23W, 230V, 50Hz

8470



36W, 3492lm, 3000K / 4000K

8470D1

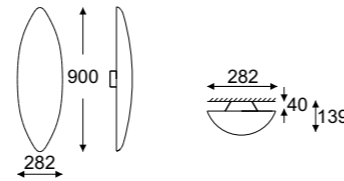

Zoe 90 narożnikowa / corner version

Index



2x max 23W, 230V, 50Hz

8510



36W, 3492lm, 3000K / 4000K

8510D1

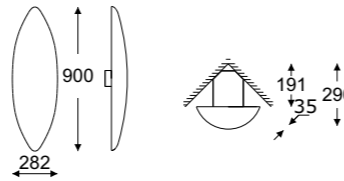

Zoe 120 ścienna / wall version

Index



2x max 23W, 230V, 50Hz

8460



36W, 3492lm, 3000K / 4000K

8460D1

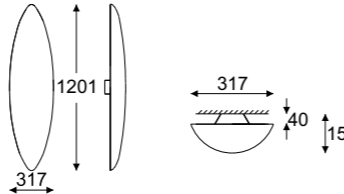

Zoe 120 narożnikowa / corner version

Index

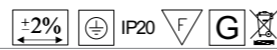

2x max 23W, 230V, 50Hz

8520



36W, 3492lm, 3000K / 4000K

8520D1

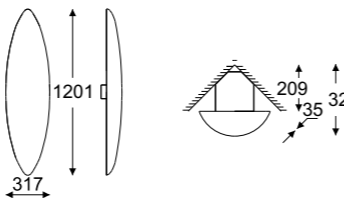



Kolumna gładka średnia / smooth medium

Index

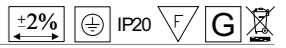

E27

1x max 23W, 230V, 50Hz

8110



LED ECO

9W, 873lm, 3000K / 4000K

8110L5

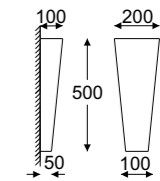

Kolumna gładka mała / smooth small

Index



E14

1x max 23W, 230V, 50Hz

8130



LED ECO

9W, 873lm, 3000K / 4000K

8130L5

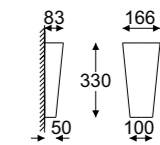

Rura gładka mała / smooth small

Index

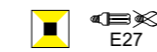

E27

1x max 23W, 230V, 50Hz

8410



LED ECO

9W, 873lm, 3000K / 4000K

8410L5

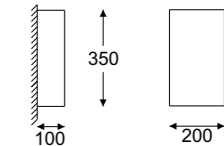

Rura gładka średnia / smooth medium

Index

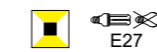

E27

2x max 23W, 230V, 50Hz

8420



LED ECO

9W, 873lm, 3000K / 4000K

8420L5

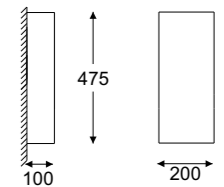

Claudia fala / wave

Index

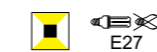

E27

2x max 23W, 230V, 50Hz

8200

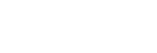

LED ECO

9W, 873lm, 3000K / 4000K

8200L5

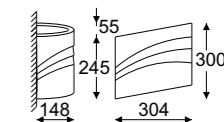

Amada oprawy wpuszczane ściennie / recessed wall lamp

Pierwsza metoda montowania / The first method of mounting



Druga metoda montowania / The second method of mounting



| | | |
|-----------------|----------------------------|-----------------|
| Amada AF | Index | |
| | 1x 18W, 230V, 50Hz | 1119AFC |
| | 4,5W, 437lm, 3000K / 4000K | 1119AFN2 |

| | | |
|-----------------|----------------------------|-----------------|
| Amada CF | Index | |
| | 1x 7/9W, 230V, 50Hz | 1119CFS |
| | 4,5W, 437lm, 3000K / 4000K | 1119CFN2 |

| | | |
|-----------------|----------------------------|-----------------|
| Amada DP | Index | |
| | 1x 7/9W, 230V, 50Hz | 1119DPS |
| | 4,5W, 437lm, 3000K / 4000K | 1119DPN2 |

| | | |
|-----------------|----------------------------|-----------------|
| Amada DF | Index | |
| | 1x 7/9W, 230V, 50Hz | 1119DFS |
| | 4,5W, 437lm, 3000K / 4000K | 1119DFN2 |

| | | |
|-----------------|----------------------------|-----------------|
| Amada HP | Index | |
| | 1x 7/9W, 230V, 50Hz | 1119HPS |
| | 4,5W, 437lm, 3000K / 4000K | 1119HPN2 |

| | | |
|-----------------|----------------------------|-----------------|
| Amada KP | Index | |
| | 1x 7/9W, 230V, 50Hz | 1119KPS |
| | 4,5W, 437lm, 3000K / 4000K | 1119KPN2 |

| | | |
|-----------------|----------------------------|-----------------|
| Amada MP | Index | |
| | 1x 7/9W, 230V, 50Hz | 1119MPS |
| | 4,5W, 437lm, 3000K / 4000K | 1119MPN2 |

Sol oprawy wpuszczane ścienne / recessed wall lamp



Sol I

Index

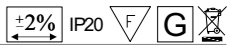

LED ECO

4,5W, 437lm, 3000K / 4000K

1211A1N2

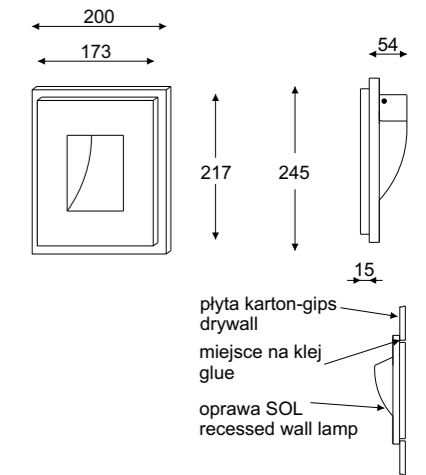

Sol II

Index



LED ECO

4,5W, 437lm, 3000K / 4000K

1211A2N2

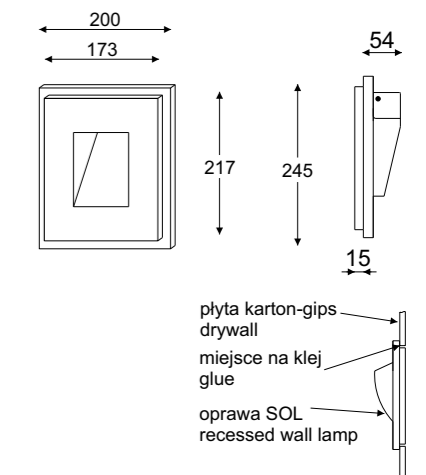
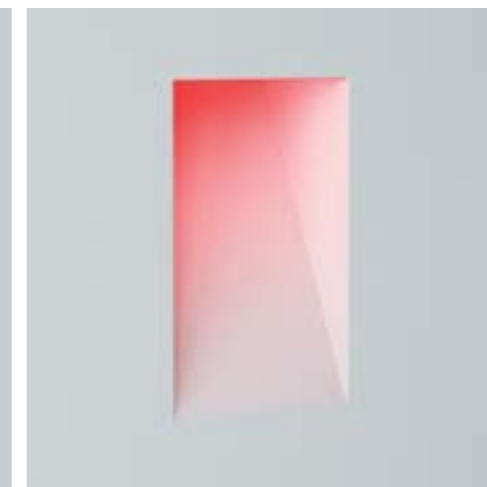

Sol III

Index

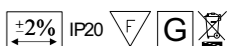

LED ECO

4,5W, 437lm, 3000K / 4000K

1211B1N2

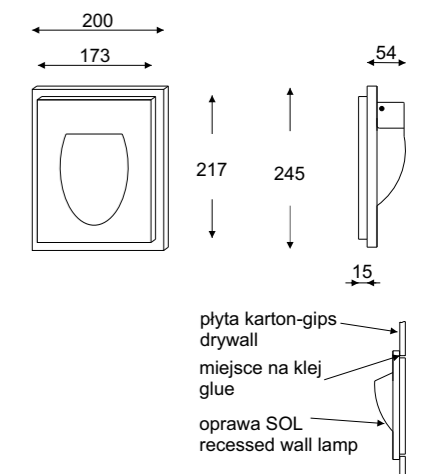

Aube oczka stropowe / ceiling- spots



| | | | | | | | | | | |
|--|-------|-------------------------|-------------|--|--|--|--|--|--|--------------|
| | E14 | R50, 1 x max 40W, 230V | 5210 | | | | | | | ±2% IP20 F G |
| | GU5,3 | MR 16, 1 x max 35W, 12V | 4210 | | | | | | | ±2% IP20 F G |
| | E14 | R50, 1 x max 40W, 230V | 5270 | | | | | | | ±2% IP20 F G |
| | GU5,3 | MR 16, 1 x max 35W, 12V | 4270 | | | | | | | ±2% IP20 F G |
| | E14 | R50, 1 x max 40W, 230V | 5190 | | | | | | | ±2% IP20 F G |
| | GU5,3 | MR 16, 1 x max 35W, 12V | 4190 | | | | | | | ±2% IP20 F G |
| | E14 | R50, 1 x max 40W, 230V | 5040 | | | | | | | ±2% IP20 F G |
| | GU5,3 | MR 16, 1 x max 35W, 12V | 4040 | | | | | | | ±2% IP20 F G |
| | E14 | R50, 1 x max 40W, 230V | 5200 | | | | | | | ±2% IP20 F G |
| | GU5,3 | MR 16, 1 x max 35W, 12V | 4200 | | | | | | | ±2% IP20 F G |
| | E14 | R50, 1 x max 40W, 230V | 5220 | | | | | | | ±2% IP20 F G |
| | GU5,3 | MR 16, 1 x max 35W, 12V | 4220 | | | | | | | ±2% IP20 F G |
| | E14 | R50, 1 x max 40W, 230V | 5260 | | | | | | | ±2% IP20 F G |
| | GU5,3 | MR 16, 1 x max 35W, 12V | 4260 | | | | | | | ±2% IP20 F G |
| | E14 | R50, 1 x max 40W, 230V | 5180 | | | | | | | ±2% IP20 F G |
| | GU5,3 | MR 16, 1 x max 35W, 12V | 4180 | | | | | | | ±2% IP20 F G |





| | | | | | |
|--|--|--|--|--|---------------------|
| | <p>E14 R50, 1 x max 40W, 230V</p> <p>GU5,3 MR 16, 1 x max 35W, 12V</p> | <p>Index</p> <p>5070</p> | | | <p>±2% IP20 F G</p> |
| | <p>E14 R50, 1 x max 40W, 230V</p> <p>GU5,3 MR 16, 1 x max 35W, 12V</p> | <p>Index</p> <p>5060</p> | | | <p>±2% IP20 F G</p> |
| | <p>E14 R50, 1 x max 40W, 230V</p> <p>GU5,3 MR 16, 1 x max 35W, 12V</p> | <p>Index</p> <p>5250</p> | | | <p>±2% IP20 F G</p> |
| | <p>E14 R50, 1 x max 40W, 230V</p> <p>GU5,3 MR 16, 1 x max 35W, 12V</p> | <p>Index</p> <p>5170</p> | | | <p>±2% IP20 F G</p> |
| | <p>E14 R50, 1 x max 40W, 230V</p> <p>GU5,3 MR 16, 1 x max 35W, 12V</p> | <p>Index</p> <p>5150</p> | | | <p>±2% IP20 F G</p> |
| | <p>E14 R50, 1 x max 40W, 230V</p> <p>GU5,3 MR 16, 1 x max 35W, 12V</p> | <p>Index</p> <p>5230</p> | | | <p>±2% IP20 F G</p> |
| | <p>E14 R50, 1 x max 40W, 230V</p> <p>GU5,3 MR 16, 1 x max 35W, 12V</p> | <p>Index</p> <p>5051</p> | | | <p>±2% IP20 F G</p> |



Lucka A





-  GZ 10 1x max 35W
-  GU 5,3 1x max 35W
-  E27 1x max 40W

oprawa dostarczana bez oczka stropowego
downlight is not included

Lucka B





-  GZ 10 1x max 35W
-  GU 5,3 1x max 35W
-  E27 1x max 40W

oprawa dostarczana bez oczka stropowego
downlight is not included

Sopra uno





-  GZ 10 1x max 35W
-  GU 5,3 1x max 35W
-  E27 1x max 40W

oprawa dostarczana bez oczka stropowego
downlight is not included

Sopra B





-  GZ 10 1x max 35W
-  GU 5,3 1x max 35W
-  E27 1x max 40W

oprawa dostarczana bez oczka stropowego
downlight is not included

Crevol A





-  GZ 10 1x max 35W
-  GU 5,3 1x max 35W
-  E27 1x max 40W

oprawa dostarczana bez oczka stropowego
downlight is not included

Crevol B



-  GZ 10 1x max 35W
-  GU 5,3 1x max 35W
-  E27 1x max 40W

Index

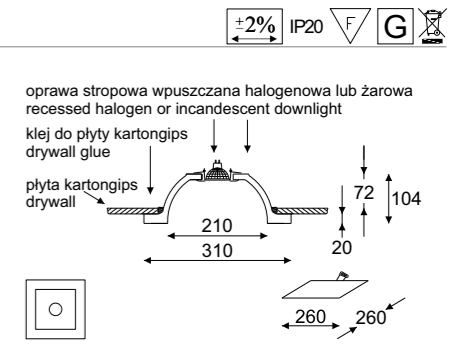

Index

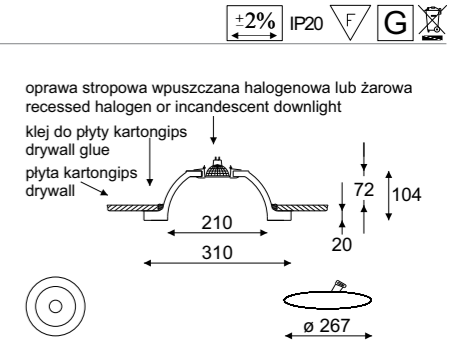

Index

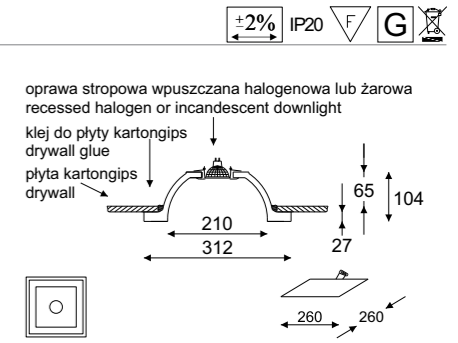

Index

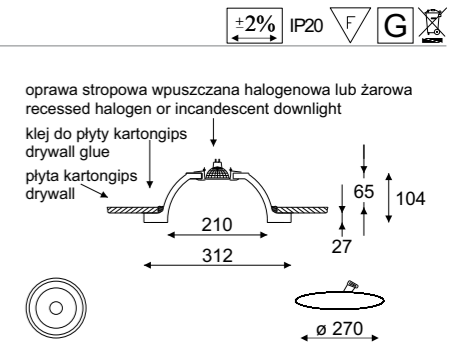

Index

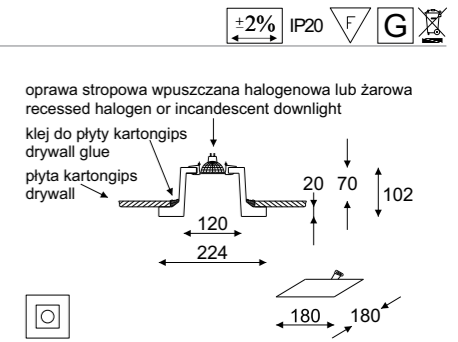

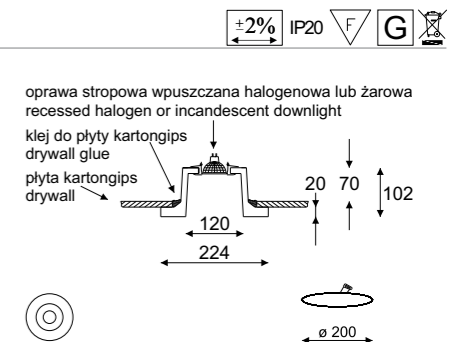

Index



Alkofra Uno



-  GZ 10 1x max 35W
-  GU 5,3 1x max 35W
-  E27 1x max 40W

oprawa dostarczana bez oczka stropowego
downlight is not included

Index

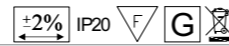

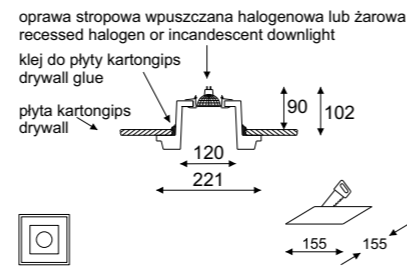

9681A



Alkofra Due



-  GZ 10 2x max 35W
-  GU 5,3 2x max 35W
-  E27 2x max 40W

oprawa dostarczana bez oczka stropowego
downlight is not included

Index

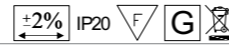

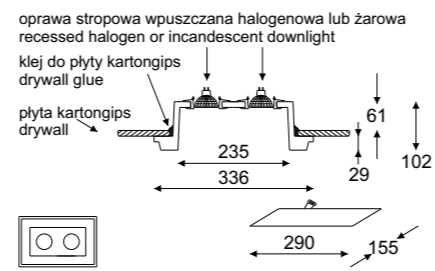

9681B



Riom Uno



-  GZ 10 1x max 35W
-  GU 5,3 1x max 35W
-  E27 1x max 40W

oprawa dostarczana bez oczka stropowego
downlight is not included

Index

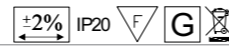

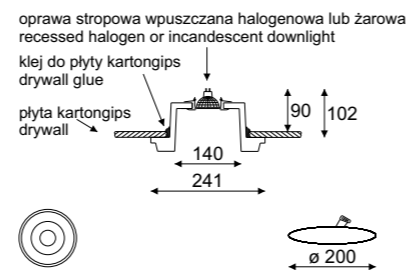

9679A



Riom Due



-  GZ 10 2x max 35W
-  GU 5,3 2x max 35W
-  E27 2x max 40W

oprawa dostarczana bez oczka stropowego
downlight is not included

Index



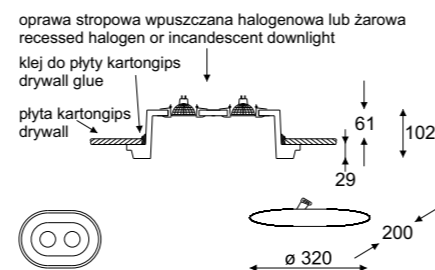

9679B



Level A



-  GZ 10 1x max 35W
-  GU 5,3 1x max 35W
-  E27 1x max 40W

oprawa dostarczana bez oczka stropowego
downlight is not included

Index



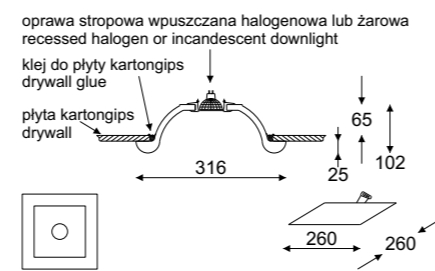

9674A



Level B



-  GZ 10 1x max 35W
-  GU 5,3 1x max 35W
-  E27 1x max 40W

oprawa dostarczana bez oczka stropowego
downlight is not included

Index



9674B

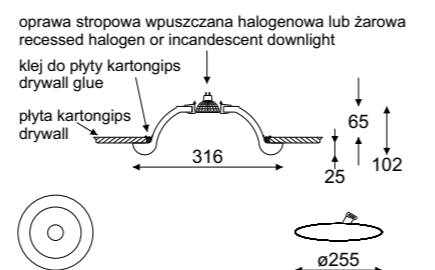

Crevol C



- GZ 10 1x max 35W
- GU 5,3 1x max 35W
- E27 1x max 40W

oprawa dostarczana bez oczka stropowego
downlight is not included

Index

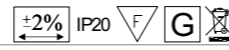

9680C

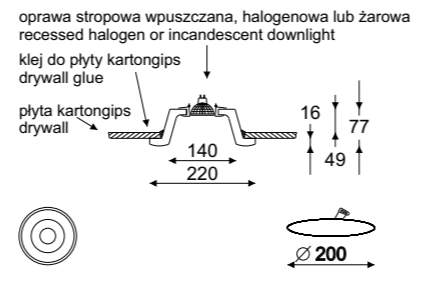

Namur B



- GZ 10 1x max 35W
- GU 5,3 1x max 35W
- E27 1x max 40W

oprawa dostarczana bez oczka stropowego
downlight is not included

Index



9673B

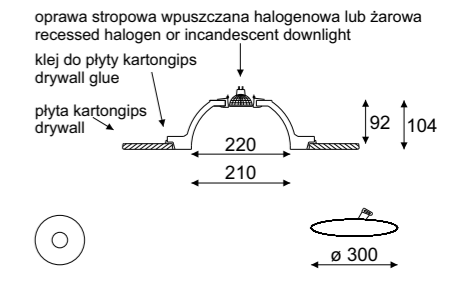

Paros Uno



- GZ 10 1x max 35W
- GU 5,3 1x max 35W
- E27 1x max 40W

oprawa dostarczana bez oczka stropowego
downlight is not included

Index

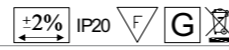

9675A

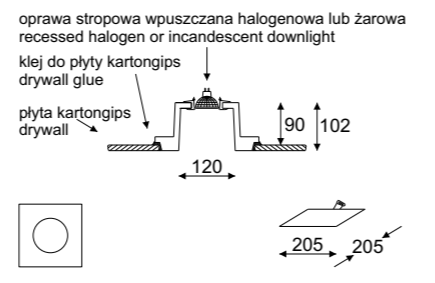

Tismo



- E27 2x max 23W
- 2GX13 1x 22W
- G10q 1x 22W

oprawa dostarczana bez oczka stropowego
downlight is not included

Index



9672A

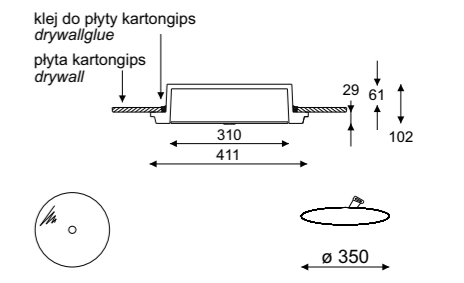

Paros Due



- GZ 10 2x max 35W
- GU 5,3 2x max 35W
- E27 2x max 40W

oprawa dostarczana bez oczka stropowego
downlight is not included

Index



9675B

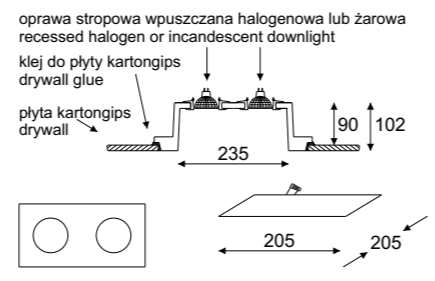

Nicolae



- E27 2x max 23W
- 2GX13 1x 22W
- G10q 1x 22W

oprawa dostarczana bez oczka stropowego
downlight is not included

Index



9683A

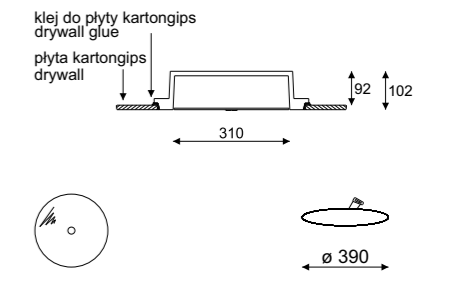

Murata Uno



- GZ 10 1x max 35W
- GU 5,3 1x max 35W
- E27 1x max 40W

oprawa dostarczana bez oczka stropowego
downlight is not included

Index

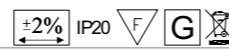

9677A

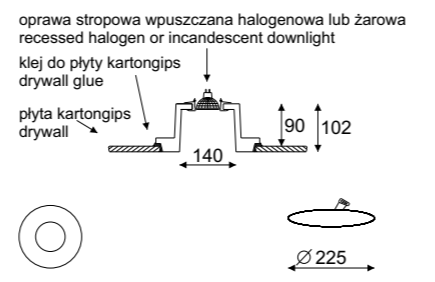

Murata Due



- GZ 10 2x max 35W
- GU 5,3 2x max 35W
- E27 2x max 40W

oprawa dostarczana bez oczka stropowego
downlight is not included

Index

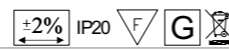

9677B

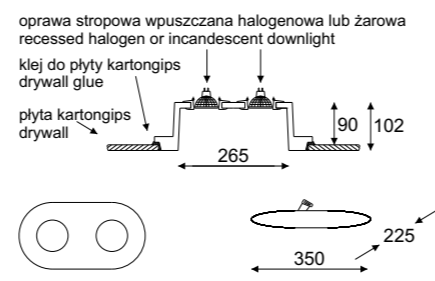

Namur A



- GZ 10 1x max 35W
- GU 5,3 1x max 35W
- E27 1x max 40W

oprawa dostarczana bez oczka stropowego
downlight is not included

Index



9673A

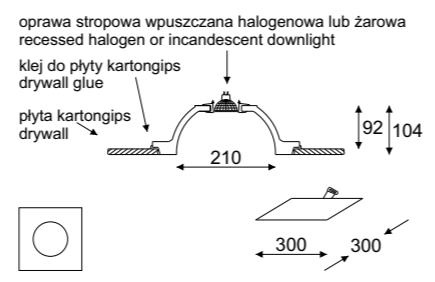



Oprawy ceramiczne

Znany materiał niespotykane kształty.

Oprawy oświetleniowe wykonane z wypalanej w piecach wysokiej jakości masy ceramicznej łączą w sobie piękno tradycyjnego materiału z formami, które często wykraczają daleko poza klasykę. Dodatkowym atutem naszych lamp ceramicznych jest możliwość późniejszego ich pomalowania, gdyż materiał ten jest niezwykle chłonny. Można więc zdecydować się na wykończenie ich w kolorze ściany bądź też zastosowanie barwy całkowicie kontrastującej z otoczeniem. nasze oprawy dowodzą, że ceramikę zastosować można nie tylko w pomieszczeniach urządzonej tradycyjnie, lecz również w tych bardziej nowoczesnych.

Ceramic lamps

Well-known material, unusual shapes.

Luminaires made of oven-baked, high quality ceramics combine the beauty of traditional materials with what of forms which often extend far beyond the classics. Another advantage of our ceramic lamps is the ability to paint them at a later time, because the material is extremely absorbent. One can choose to cover them with the colour of the walls or a colour which contrasts with the surrounding environment. Our luminaires show that ceramics can be used not only in traditionally decorated interiors, but also in more modern ones.



Urson wisząca / hanging lamp

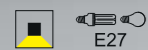

1x max 60W, 230V, 50Hz

Index

1323A1

new ±2% IP20 F C

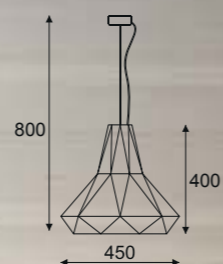

Urial



Urial plafon / ceiling lamp

new ±2% IP20 F C



1x max 23W, 230V, 50Hz

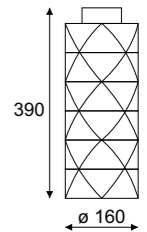
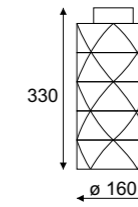
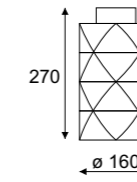
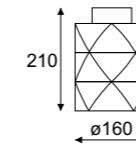

Index

1324PA1

1324PA2

1324PA3

1324PA4

Urial wisząca / hanging lamp

new ±2% IP20 F C



1x max 23W, 230V, 50Hz

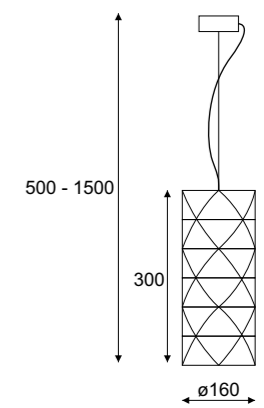
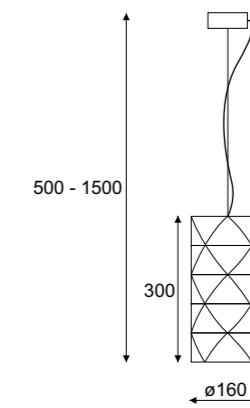
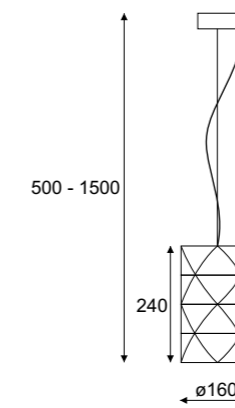
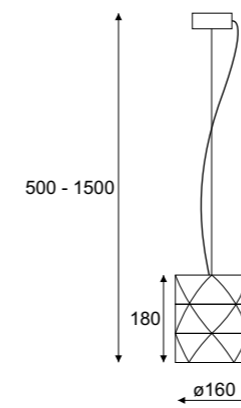

Index

1324WA1

1324WA2

1324WA3

1324WA4

*Oprawa szkliona dostępna w kolorze białym

Toke



Toke wisząca / hanging lamp



3x max 60W, 230V, 50Hz

Index

1319M
color 10

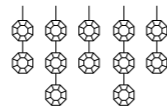
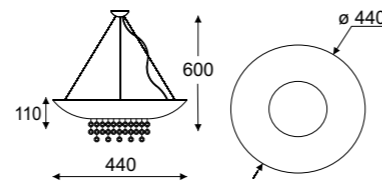

Powłoki pozłotnicze color 10:



942 - Schlagmetal złoty



944 - Schlagmetal srebrny



945 - Schlagmetal miedź

Kubik



Kubik ścienny z dolnym szkłem / wall lamp with bottom glass

Index

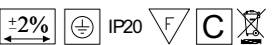

E27

1x max 60W, 230V, 50Hz

1038A



G9

1x max 40W, 230V, 50Hz

1038B

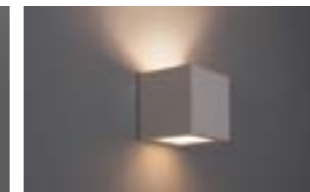
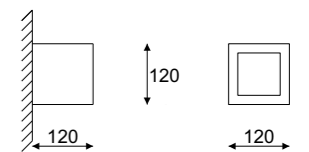

Kubik ścienny z dolnym nacięciem / wall lamp with bottom slit

Index

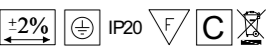

E27

1x max 60W, 230V, 50Hz

1038E



G9

1x max 40W, 230V, 50Hz

1038G

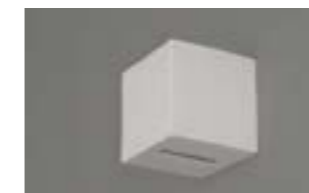
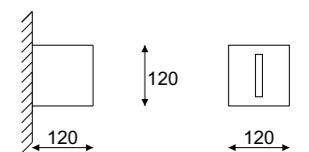

Kostka sufitowa / ceiling lamp

Index

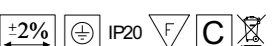

G9

1x max 40W, 230V, 50Hz

1780

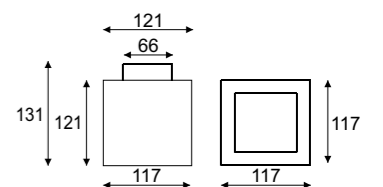



Goja kinkiet / wall lamp

Index

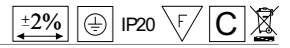

G9

2x max 40W, 230V, 50Hz

1095

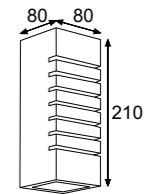

Komo plus kinkiet / plus wall lamp

Index

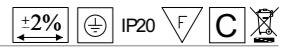

G9

2x max 40W, 230V, 50Hz

1098B

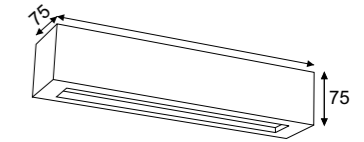

Hagi biała ze szkłem / white with glass

Index



E27

1x max 60W, 230V, 50Hz

1350

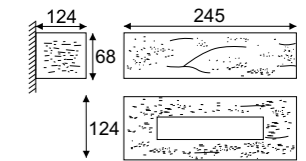

Hagi biała / white

Index

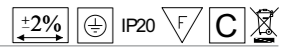

E27

1x max 60W, 230V, 50Hz

1351

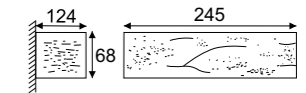

Torino kinkiet wall lamp

Index

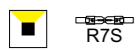

R7S

1x max 200W, 230V, 50Hz

1053A

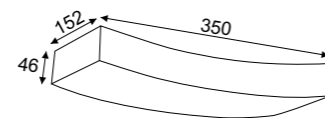

Omegi



Omega wąska C / narrow C

 1x max 60W, 230V, 50Hz **Index 1340**

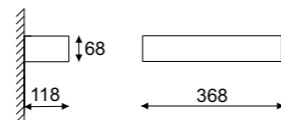

Omega narożnikowa G / corner lamp G

 1x max 60W, 230V, 50Hz **Index 1220**

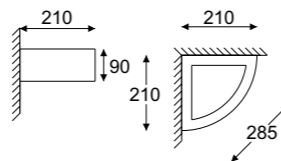

Omega ścienna A / wall lamp a

 1x max 60W, 230V, 50Hz **Index 1160**

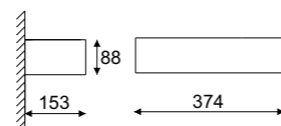

Omega H kinkiet / wall lamp

 1x max 40W, 230V, 50Hz **Index 1022**

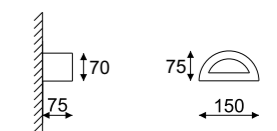
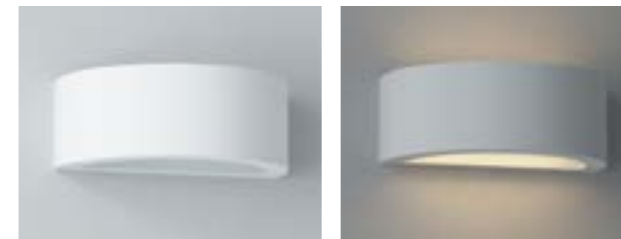

Omega I kinkiet / wall lamp

 1x max 40W, 230V, 50Hz **Index 1023**

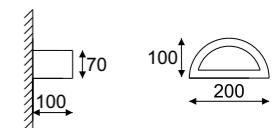

Omega J kinkiet / wall lamp

 1x max 60W, 230V, 50Hz **Index 1024**

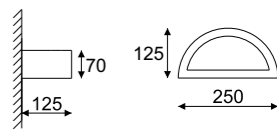

Omega K kinkiet / wall lamp

 1x max 60W, 230V, 50Hz **Index 1025**

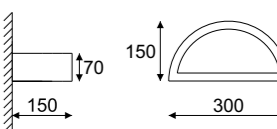

Omega L kinkiet / wall lamp

 1x max 60W, 230V, 50Hz **Index 1026**

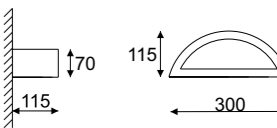



Omega 40 B kinkiet / wall lamp

Index

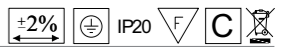

1x max 60W, 230V, 50Hz

1370

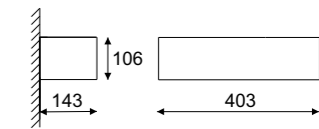

Omega pasek D / stripe D

Index

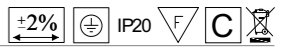

1x max 60W, 230V, 50Hz

1360

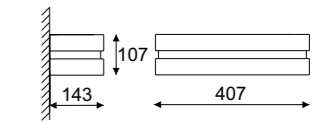

Omega grawer E / engraver E

Index

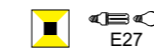

1 x max 60W, 230V, 50Hz

1520

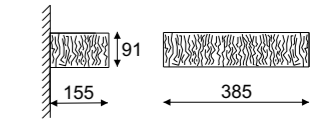

Omega M papier kinkiet / wall lamp

Index

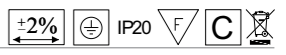

1x max 60W, 230V, 50Hz

1027

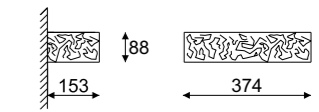

Omega fala F / wave F

Index

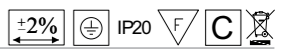

1x max 60W, 230V, 50Hz

1210

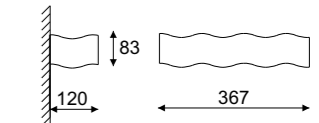



Omega 360 wisząca / hanging lamp

Index



2x max 60W, 230V, 50Hz

1570A

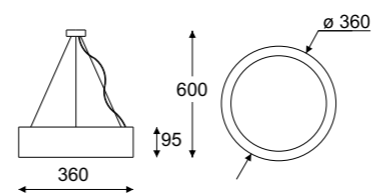
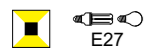

Omega 360 plafon / ceiling lamp

Index



2x max 60W, 230V, 50Hz

1572

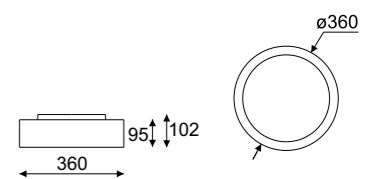

Omega 440 wisząca / hanging lamp

Index



3x max 60W, 230V, 50Hz

1571

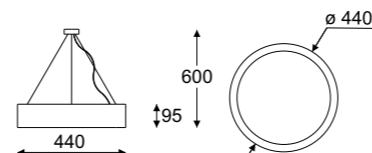
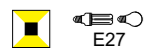

Omega 440 plafon / ceiling lamp

Index



3x max 60W, 230V, 50Hz

1573

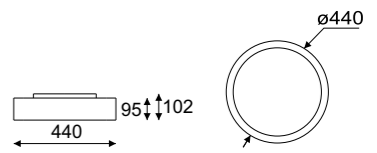

Odi



Odi sufitowe / ceiling lamp



1x max 40W, 230V, 50Hz

Index

1781

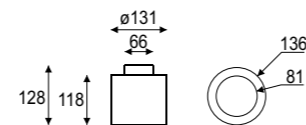

Odi sufitowe / ceiling lamp



1x max 40W, 230V, 50Hz

Index

1782

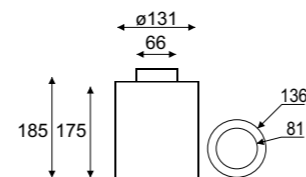
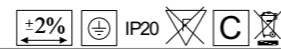

Emiko



Emiko wisząca / hanging lamp



1x max 40W, 230V, 50Hz

Index

1860

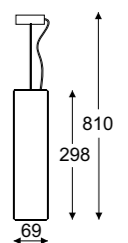



Grecka kinkiet / wall lamp



1x max 60W, 230V, 50Hz

Index

1030

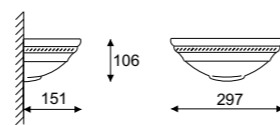

Milo greckie / greek



3x max 60W, 230V, 50Hz

Index

1652

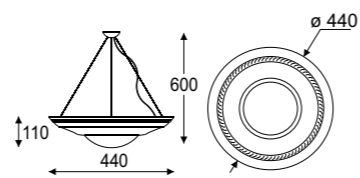

Roma I koło / circle



3x max 60W, 230V, 50Hz

Index

1810

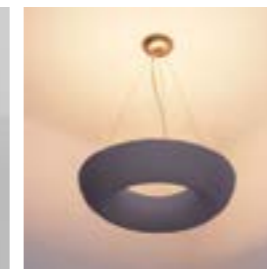
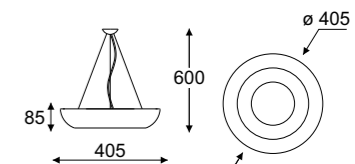

Milo gładkie / smooth



3x max 60W, 230V, 50Hz

Index

1650

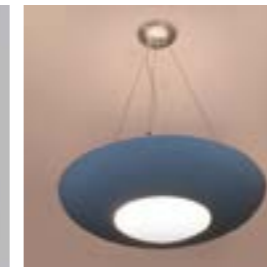
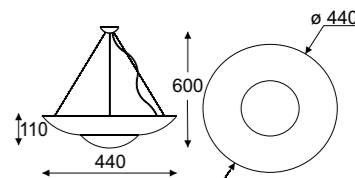



Noceto gladkie / smooth

Index



1x max 60W, 230V, 50Hz

1312

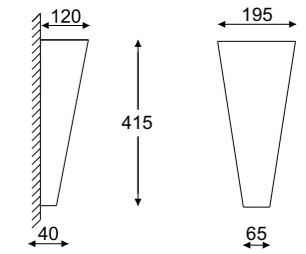
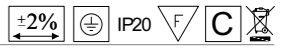

Tulka kinkiet / wall lamp

Index



1x max 60W, 230V, 50Hz

1313

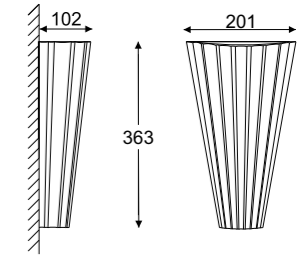
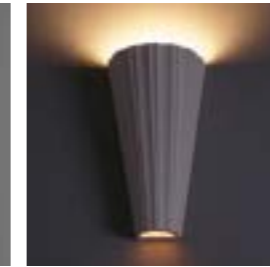
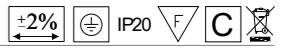

Merkato kinkiet / wall lamp

Index



1x max 60W, 230V, 50Hz

1315

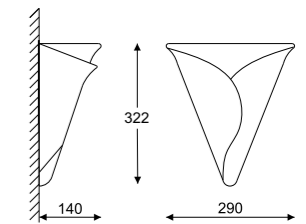
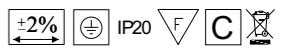

Monagri kinkiet / wall lamp

Index



1 x max 60W, 230V, 50Hz

1037

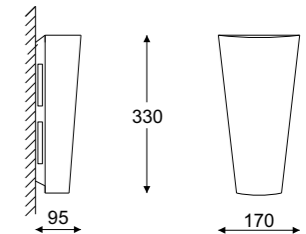
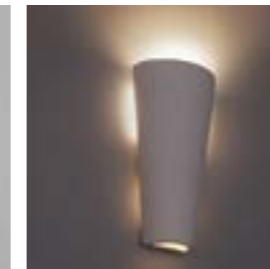
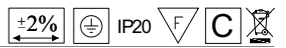

Monagri II kinkiet / wall lamp

Index



1x max 60W, 230V, 50Hz

1039

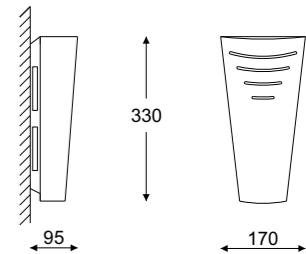
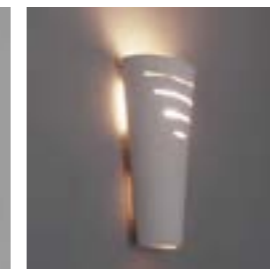
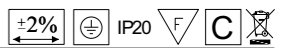

Noceto klin / wedge

Index



1x max 60W, 230V, 50Hz

1311

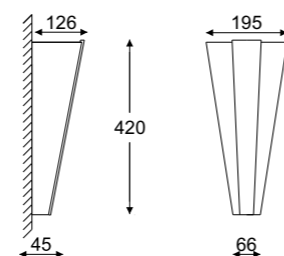
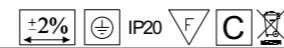



Kampia kinkiet / wall lamp

Index

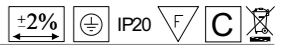

1x max 60W, 230V, 50Hz

1317

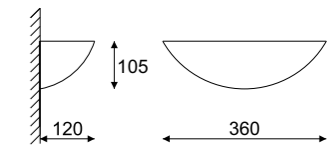

Dafni kinkiet / wall lamp

Index



1x max 60W, 230V, 50Hz

1051

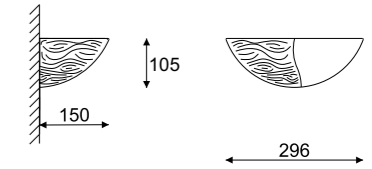

Tudora

Index

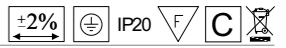

1x max 60W, 230V, 50Hz

1028

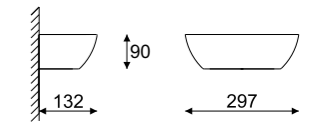

Tudora papier / paper

Index

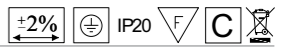

1x max 60W, 230V, 50Hz

1029

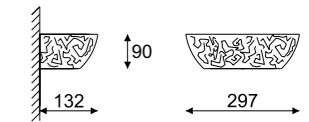

Dinas II kinkiet / wall lamp

Index

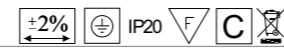

1x max 60W, 230V, 50Hz

1046

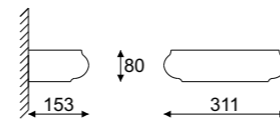

Wiedeńska średnia / medium

Index

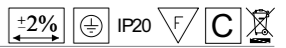

1x max 60W, 230V, 50Hz

1140

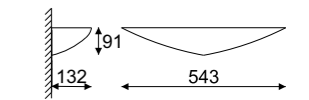

Dinas I kinkiet / wall lamp

Index



1x max 60W, 230V, 50Hz

1045

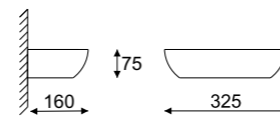

Wiedeńska mała / small

Index



1x max 60W, 230V, 50Hz

1130

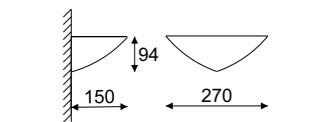

Solda kinkiet / wall lamp

Index



1x max 60W, 230V, 50Hz

1035

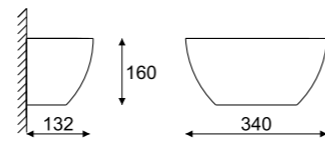

Tulipan

Index

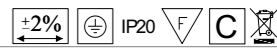

1x max 60W, 230V, 50Hz

1200

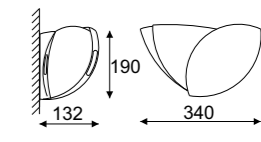

Liza A gładka kinkiet / wall lamp

Index

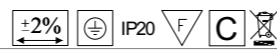

1x max 60W, 230V, 50Hz

1052A

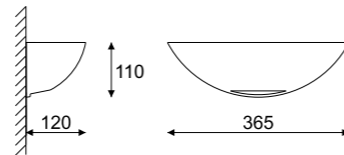

Siatka ścienna / wall lamp

Index

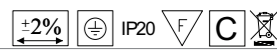

1x max 60W, 230V, 50Hz

1400

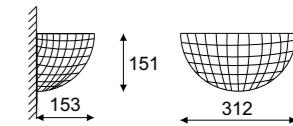

Liza B paski kinkiet / wall lamp

Index

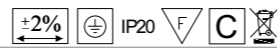

1x max 60W, 230V, 50Hz

1052B

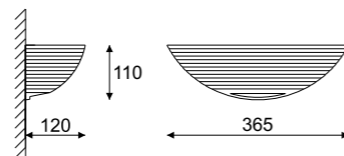

Siatka narożnikowa / corner lamp

Index

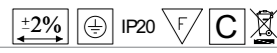

1x max 60W, 230V, 50Hz

1410

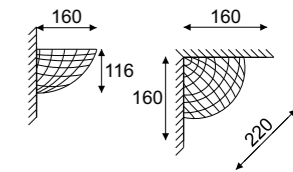

Muszelka kinkiet / wall lamp

Index



1x max 60W, 230V, 50Hz

1153

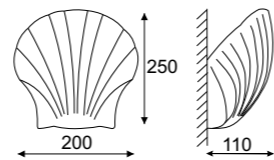

Cegielka

Index

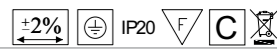

1x max 60W, 230V, 50Hz

1050

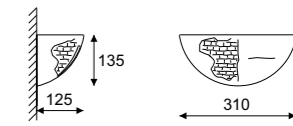

Liść kinkiet / wall lamp

Index

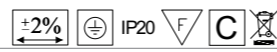

1x max 60W, 230V, 50Hz

1190

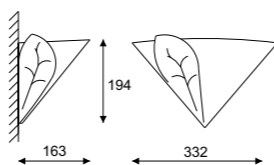

Piaskowa

Index

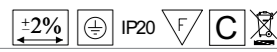

1x max 60W, 230V, 50Hz

1120

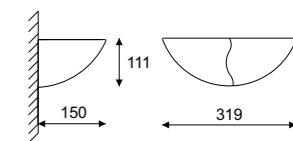

Saturn

Index

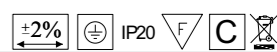

1x max 60W, 230V, 50Hz

1020

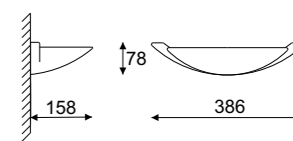

Nina ścienna / wall lamp

Index

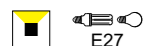
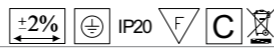

1x max 60W, 230V, 50Hz

1010

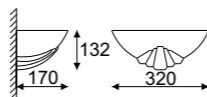

Nina narożnik / corner lamp

Index

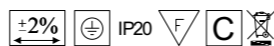

1x max 60W, 230V, 50Hz

1110

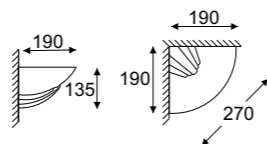

Hiszpan ścienny / wall lamp

Index

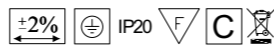

1x max 60W, 230V, 50Hz

1170

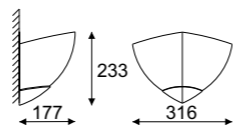

Hiszpan narożnik / corner lamp

Index



1x max 60W, 230V, 50Hz

1180

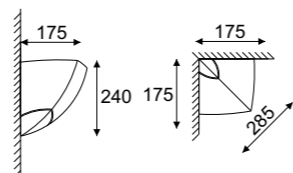

Sara kinkiet / wall lamp

Index

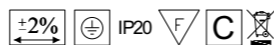

1x max 60W, 230V, 50Hz

1070

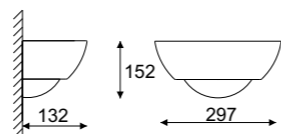

Kula ścienna / wall lamp

Index



1x max 60W, 230V, 50Hz

1100

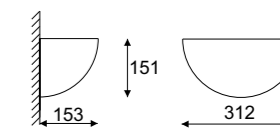

Kula narożnik / corner lamp

Index



1x max 60W, 230V, 50Hz

1090

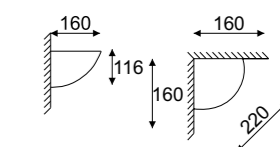

Tabele kolorów i opisy. Tables of colors and descriptions.

Color 1 - stal / steel

| | | | | | |
|--|--|--|--|--|--|
| | | | | | |
| | | | | | |
| | | | | | |
| | | | | | |
| | | | | | |
| | | | | | |

| | | | | | |
|--|--|--|--|--|--|
| | | | | | |
| | | | | | |
| | | | | | |
| | | | | | |
| | | | | | |
| | | | | | |



* color standardowy
** color niestandardowy
*** color ponadstandardowy

Color 2 - sklejka fornirowana

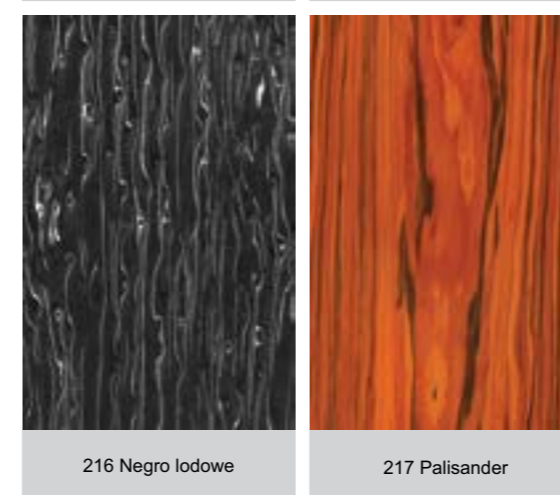
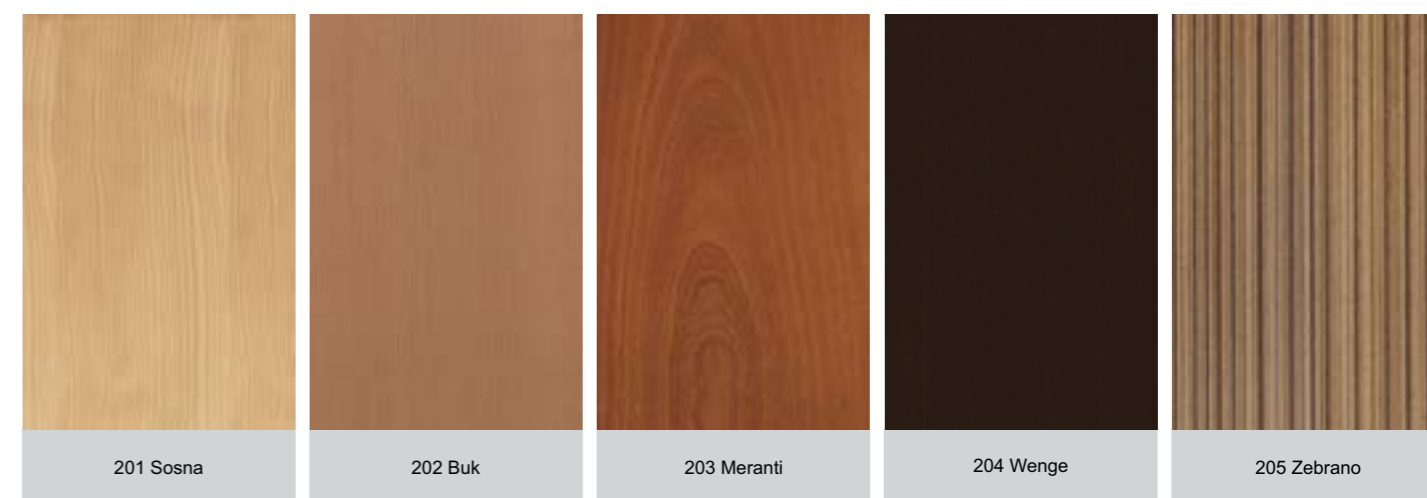

Color 3 - drewna / wood



302 Meranti

303 Palisander

304 Orzech

305 Dąb

306 Wenge

Color 5 - aluminium anodowane szczotkowane



Aluminium anodowane szczotkowane

Color 6 - Galwanika



Chrom

Miedź

Mosiądz

Color 8 - metale malowane proszkowo w kolorze bezbarwnym



Surowa stal

Ocynk biały

Color 9 - lakier do drewna / żywicy wysoki połysk



Biały wysoki połysk

Czarny wysoki połysk

Czerwony wysoki połysk

RAL 9016

RAL 9005

RAL 3002

Color 10 - powłoki pozłotnicze



Schlagmetal złoty

Schlagmetal srebrny

Schlagmetal miedź

Color 11 - lakier do drewna / żywicy matowy



Biały mat

Czarny mat

Czerwony mat

RAL 9016

RAL 9005

RAL 3002

Color 13 - stal nierdzewna polerowana



Stal nierdzewna polerowana

Color 14 - polerowane aluminium



Aluminium polerowane

Color 15 - postarzone powłoki galwaniczne



Mosiądz

Miedź

Color 16 - beton

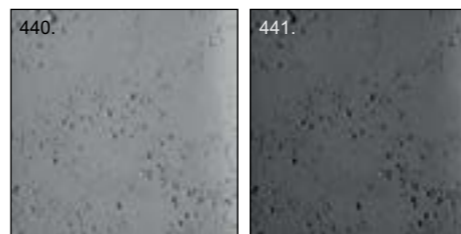

Beton jasny

Beton ciemny

Color 17 - aluminium anodowane gładkie



Aluminium anodowane gładkie

Color 18 - lakier metalizowany

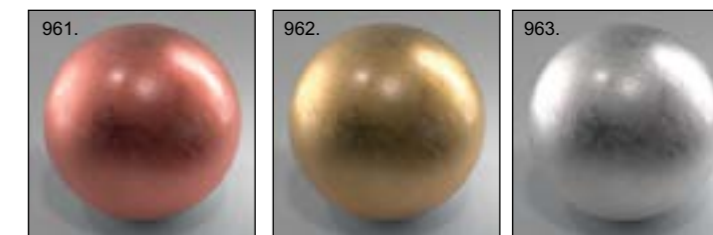

Kolor miedzi

Kolor złota

Kolor srebra

Przewody w oplocie

| | P1 | P2 | Z2 | T2 | Z1 | F1 | F2 | C | E | P3 |
|-----|----------|-----------|-----------------|----------|----------|-------------|-------------|-----------|-------------|----------|
| | beżowy | karmelowy | żółty cytrynowy | błękitny | żółty | pudrowy róż | fioletowy | niebieski | czarny | brązowy |
| * | RAL 1001 | RAL 1011 | RAL 1016 | | RAL 1021 | RAL 3015 | RAL 4005 | RAL 5012 | RAL 9005 | RAL 8003 |
| ** | | | | S-1040-B | | | S-2040-R50B | | S-2065-R90B | |
| *** | 112 | 149 | 151 | | 148 | 251 | 115/252 | 121 | 116 | 253 |

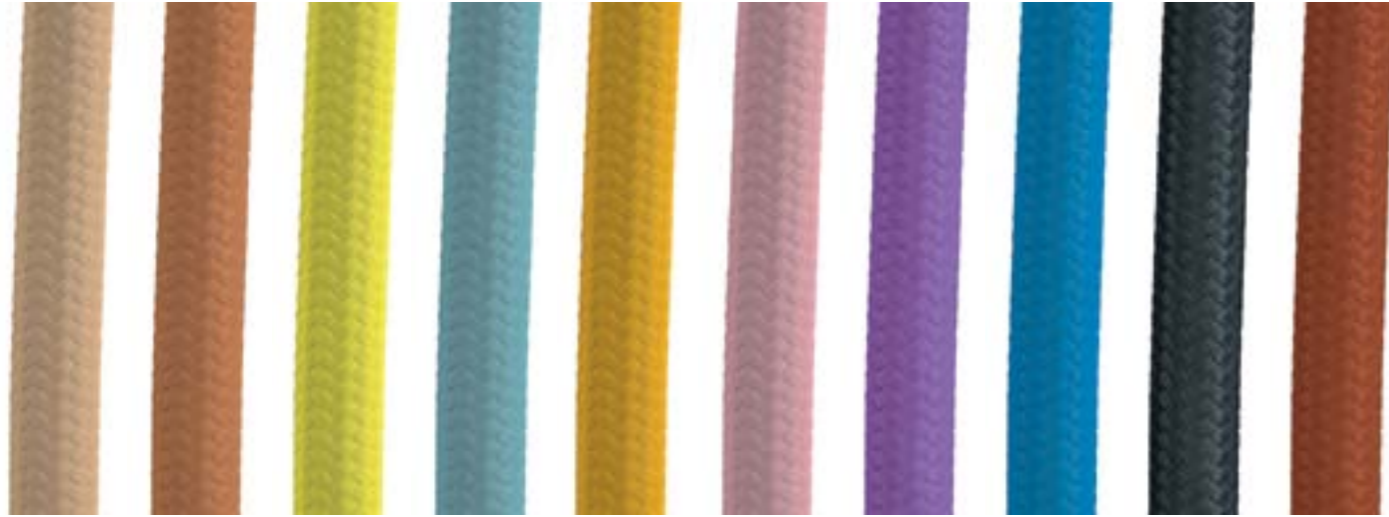

| | B | A | D | M1 | F3 | T1 | J1 | S1 | N3 | R1 |
|-----|--------------|----------|-------------|------------|-------------|-----------|---------------|----------|-------------------|-------------|
| | pomarańczowy | czerwony | zielony | amarantowy | miętowy | turkusowy | żelazko | srebrny | niebieski głęboki | biały |
| * | RAL 2003 | RAL 3002 | RAL 6018 | RAL 4010 | RAL 6019 | | RAL 9005/9016 | RAL 7040 | RAL 5015 | RAL 9016 |
| ** | S-1080-R | | S-2070-G20Y | | S-0520-B90G | | S-1050-B10G | | S-2502-B | S-2065-290B |
| *** | 114 | 110 | 126 | 133 | 254 | 142 | 117 | 128 | 170 | 113/117 |













Uwaga

Producenci przędz nie posługują się paletą Ral oraz NCS. Przędza za każdym razem inaczej zachowują się przy wybarwieniu, mimo użycia stałej, zadanej proporcji kolorów.

- * paleta kolorów RAL
- ** paleta kolorów NCS
- *** odpowiednik Color 1













OPIS STOSOWANYCH OZNACZEŃ:

-  Pierwsza klasa ochrony przed porażeniem prądem elektrycznym
-  Druga klasa ochrony przed porażeniem prądem elektrycznym
-  Trzecia klasa ochrony przed porażeniem prądem elektrycznym
-  Oprawa oświetleniowa nadająca się do bezpośredniego zamontowania na powierzchniach normalnie palnych
-  Oprawa oświetleniowa nadająca się do bezpośredniego zamontowania wyłącznie na powierzchniach niepalnych
-  Zakaz umieszczania zużytego sprzętu w pojemnikach na odpady domowe.
-  Oznaczenie zgodności z mającymi zastosowanie dyrektywami unijnymi.
-  Oprawy proekologiczne
- IP20** Brak ochrony przed wnikaniem wody
-  Wymiar otworu montażowego
-  Tolerancja wymiaru $\pm 2\%$
- AL** Aluminium
- B** Szkło barollo
- C** Masa ceramiczna
- G** Masa gipsowa
- MB** Masa betonowa
- P** Sklejka
- PL** Plexi
- S** Stal
- SB** Szkło piaskowane
- W** Drewno
- Ż** Laminat z żywicy poliestrowej



ICONS AND MARKINGS DESCRIPTION:

-  *First class of electrical protection.*
-  *Second class of electrical protection.*
-  *Third class of electrical protection.*
-  *Fittings are suitable for fixing to normally flammable surfaces*
-  *Fittings are suitable for fixing to inflammable surfaces only.*
-  *Disposing to the household waste is not allowed.*
-  *Icon of conformity with essential directives of new approach.*
-  *Light green*
- IP20** *No protection against water*
-  *Mounting Hole Dimension*
-  *Dimension tolerance $\pm 2\%$*
- AL** *Aluminium*
- B** *Barollo glass*
- C** *Ceramic mass*
- G** *Gypsum mass*
- MB** *Concrete mass*
- P** *Plywood*
- PL** *Plexi*
- S** *Steel*
- SB** *Sand-blasted glass*
- W** *Wood*
- Ż** *Polyester resin*



Producent opraw oświetleniowych
Luminaires manufacturer

Rożnowo, ul. Usługowa 19
64-600 Oborniki
Poland

tel: +48 (61) 29 77 200
fax: +48 (61) 29 77 103

e-mail: cleoni@cleoni.pl
www.cleoni.pl